

# BC-1

Flat-front constant directivity horn

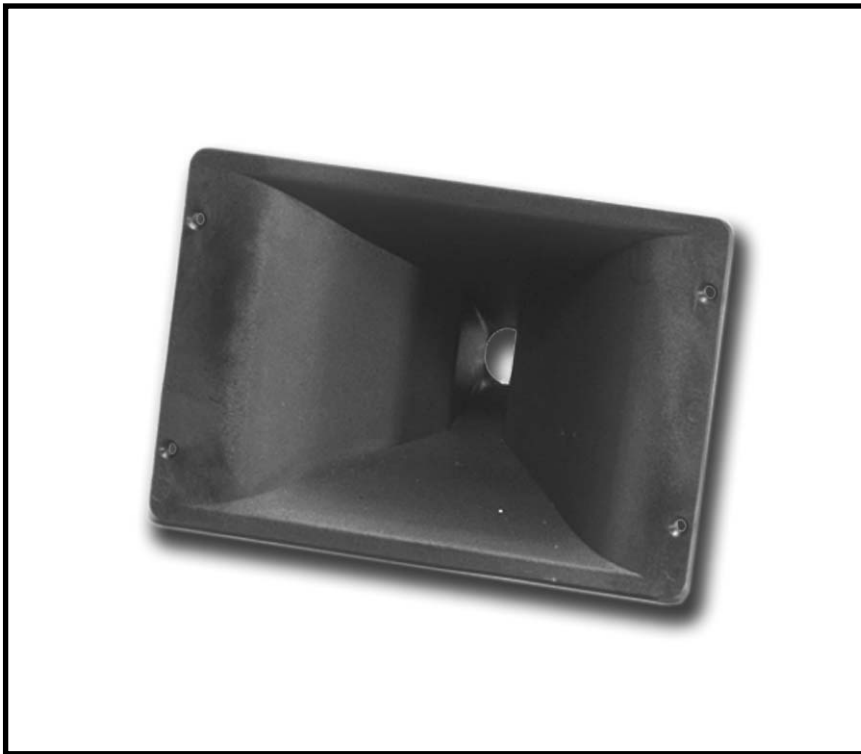

## FEATURES

- » Flat-front constant directivity horn
- » 80° x 60° nominal dispersion
- » 1" throat entry
- » Sturdy polypropylene construction

## SPECIFICATIONS

<b>-6 dB Beamwidths<sup>B</sup>:</b> (average, 1 kHz to 12.5 kHz)	82° (+16°, -11°) Horizontal 61° (+50°, -27°) Vertical
<b>Directivity, Q (R<sub>θ</sub>)<sup>C</sup>:</b>	13.1 (+6, -6)
<b>Di<sup>D</sup>:</b> (average, 1 kHz to 12.5 kHz)	11.2 dB (+1.6, -3.3)
<b>Minimum Usable Frequency:</b>	700 Hz
<b>Minimum Recommended X-over Freq.:</b>	1000 Hz / 900 Hz (with M-3 / M-5 drivers)
<b>On-axis Nominal SPL 2.83V / 1 m<sup>E</sup>:</b>	105 dB SPL with M-3 driver 108 dB SPL with M-5 driver
<b>Nominal Throat Diameter:</b>	1"
<b>Material:</b>	Pressure molded polypropylene
<b>Colour:</b>	Black
<b>Mechanical Connection of Driver:</b>	Screw-on, Whitworth 1 <sup>3</sup> / <sub>8</sub> "-18 thread, metal
<b>Dimensions (H x W x D):</b>	179 x 268 x 148 mm (7.1 x 10.6 x 9.0 in)
<b>Minimum Baffle Cutout:</b>	195 x 160 mm (7.7 x 6.3 in)
<b>Weight:</b>	0.60 kg (1.3 lbs)
<b>Shipping Weight:</b>	0.90 kg (2.0 lbs)

## DESCRIPTION

The BC-1 is compact sized flat-front constant directivity horn, delivering a 80° constant horizontal dispersion and 60° vertical coverage.

The high frequency rolloff shown in the frequency response overleaf is a characteristic of constant directivity horns that arises from the transducer's falling power response. When used as part of a passive system, it may be compensated at the input filter stage. When used fully active, generic processors will normally feature CD horn equalization.

## MOUNTING

The unit can be mounted to enclosures by four 5 mm diameter screws.

The horn's sturdy polypropylene construction allows for mounting directly to an enclosure's front, with no need for an additional support panel.

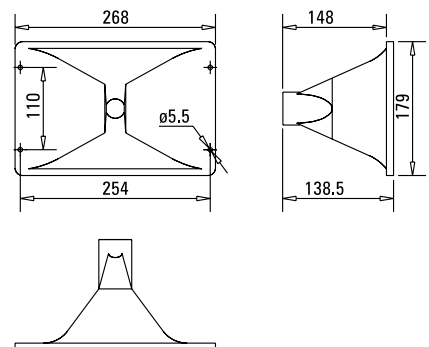

ALL DIMENSIONS IN MILLIMETERS

<sup>B</sup> Average of one-third octave band measures. One and one-third octave bands comply to ANSI S1.11-1986  
<sup>C</sup> Computed from two degree resolution vertical and horizontal one-third octave polars using sinusoidal weighting.  
<sup>D</sup> 10 log(Q).

<sup>E</sup> IEC average 1.25 kHz to 8 kHz.

Polars were measured at two degree angular and 1/24th octave frequency resolution. AUTOPOL, a platform consisting of custom and customized hardware and software, was used for the automated high-resolution acquisition and post-processing of directivity data. The digital storage of the data allows further processing and conversion to other software formats. Modelling data can be found at <http://www.dasaudio.com/>.

**Frequency Response**

Figure 1 shows the frequency response at 1 m of a BC-1/M-3 horn and driver set radiating to an anechoic environment and driven by a 2.83 V swept sine signal. Figure 4 shows the same for a BC-1/M-5 horn and driver set. Grey curves show response with filter network shown below.

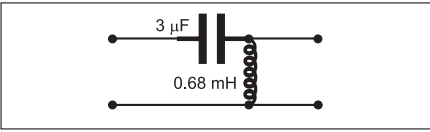

**Impedance**

Figure 2 shows impedance with frequency of a BC-1/M-3 horn and driver set. Figure 5 shows the same for a BC-1/M-5 horn and driver set.

**Distortion**

Figure 3 shows the Second Harmonic Distortion (grey) and Third Harmonic Distortion (dotted) curves for a BC-1/M-3 horn and driver set at 5.5 V. Figure 6 shows the same for a BC-1/M-5 horn and driver set at 6.7 V.

**Beamwidth**

Figure 7 shows the -3, -6 and -10 dB horizontal (solid) and vertical (dashed) beamwidth with frequency curves. -6 dB ones are shown with thicker traces for clarity.

**Axial Directivity Q(R<sub>θ</sub>) and D<sub>i</sub>**

Figure 8 shows the above characteristics with frequency.

**Relative frequency responses**

Figure 9 shows the relative frequency responses in 15 degree increments to half the nominal coverage angle.

NOTES. 1.Frequency response: referred to 1 m; low end obtained through the use of near field techniques; one-third octave smoothed for correlation with human hearing. 2.In practice, cable and connector impedance need to be added. 3.Harmonic distortion components are not plotted beyond 20 kHz; near-field techniques used. 4.Directivity characteristics plotted with respect to frequency are the average within the one-third octave bands of center frequencies noted by the marks at the bottom of the graphs, but are joined up for display purposes. All other characteristics plotted vs. frequency use 1/24th octave resolution. Regions of less than 1 dB below goal level and sharp notches may be ignored when calculating beamwidths. 5.Directivity factor and index were computed from two degree resolution vertical and horizontal polars using sinusoidal weighting. 6.Polars were acquired by placing the unit on a computer controlled turntable inside our anechoic chamber. Measurement distance was 4 m.

Product improvement through research and development is a continuous process at D.A.S. Audio. All specifications subject to change without notice.

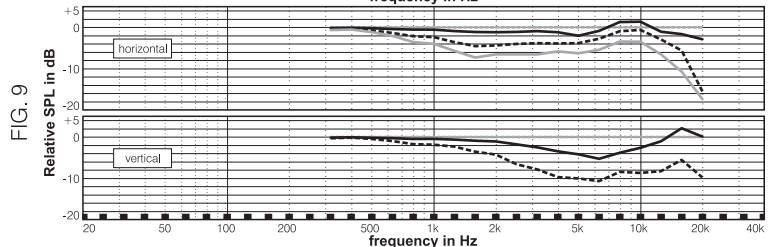
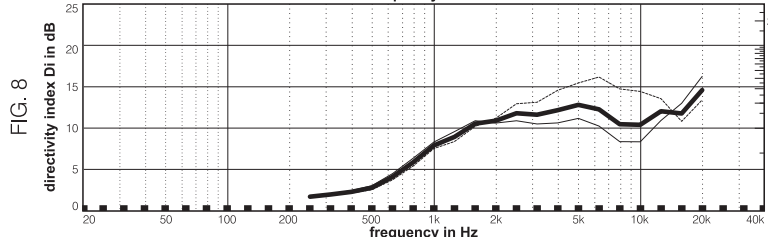
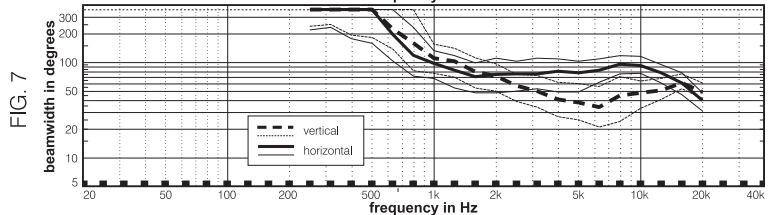
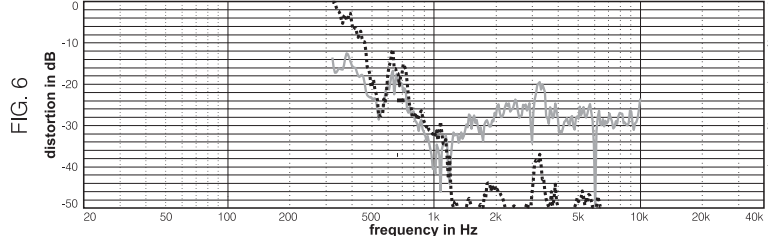
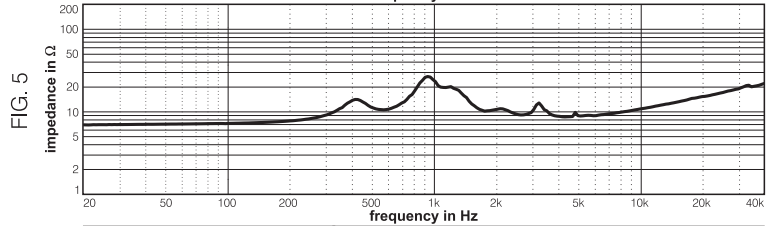
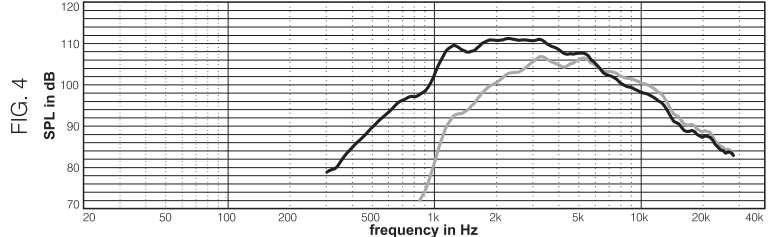
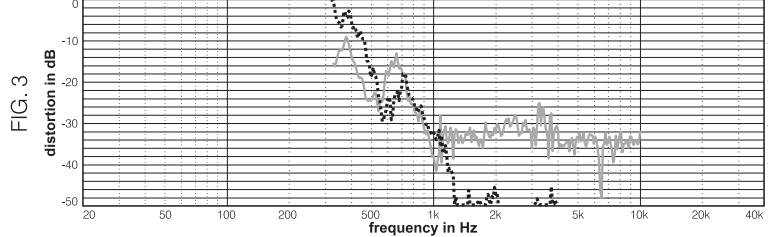
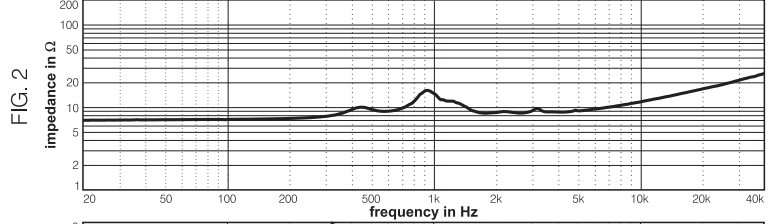
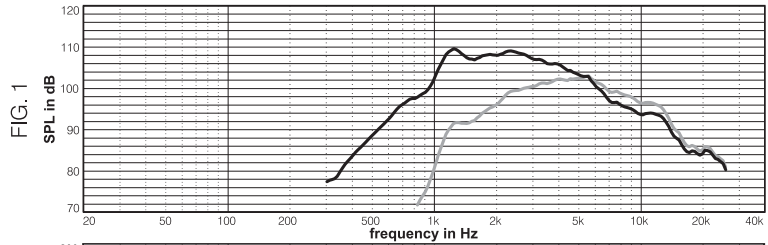

**Polar Response**

Figure 10 shows the third-octave band horizontal (solid) and vertical (dashed) polars for the indicated frequencies. Full scale is 50 dB, 5 dB per division.

FIG. 10

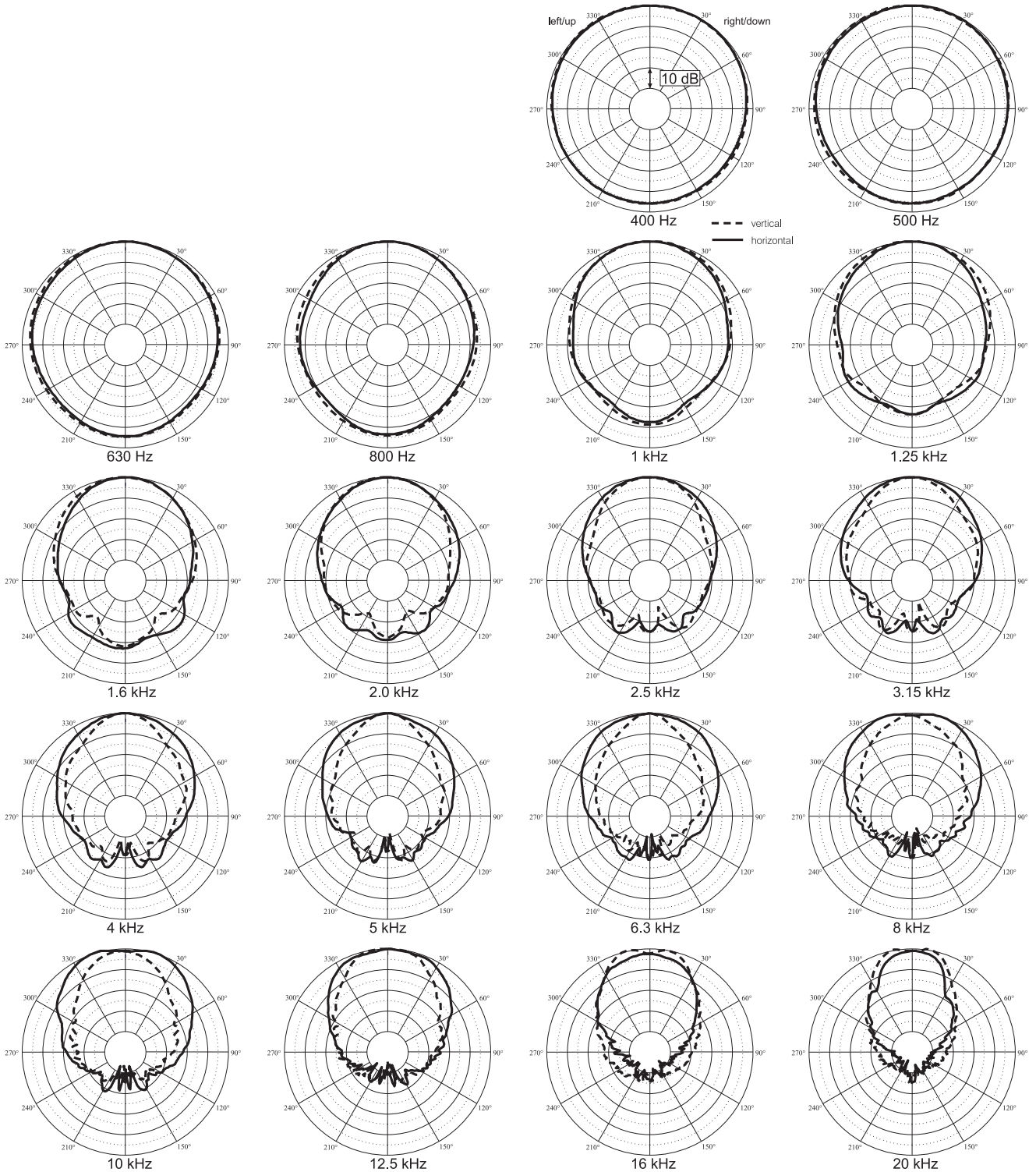

Directivity parameters for one-octave bands are given below:						
	500 Hz	1 kHz	2 kHz	4 kHz	8 kHz	16 kHz
Horizontal -6 dB coverage angle	168°	93°	74°	78°	89°	62°
Vertical -6 dB coverage angle	242°	111°	68°	44°	40°	53°
Directivity Q(R <sub>θ</sub> )	2.4	6.2	12.9	16.5	13.6	19.3
D <sub>i</sub>	3.8 dB	7.9 dB	11.1 dB	12.2 dB	11.3 dB	12.9 dB



**D.A.S. Audio, S.A.**

C/. Islas Baleares, 24 - 46988 Fuente del Jarro - Valencia, SPAIN  
Tel. 96 134 0525 - Tel. Intl. +34 96 134 0860 - Fax. 96 134 0607 - Fax. Intl. +34 96 134 06 07

**D.A.S. Audio of  
America, Inc.**

Sunset Palmetto Park 6816 NW 77th Court, Miami, FL  
33166, U.S.A. Tel. 305 436 0521 - Fax. 305 436 0528

<http://www.dasaudio.com>