

BP-92

Flat-front constant directivity horn



FEATURES

- » Flat-front constant directivity horn
- » 90° x 60° nominal dispersion
- » 1.5" throat entry
- » High pressure injection molded aluminium

SPECIFICATIONS

-6 dB Beamwidths^B: (average, 800 Hz to 12.7 kHz)	83° (+11°, -22°) Horizontal 66° (+41°, -36°) Vertical
Directivity, Q (R_θ)^C: D _i ^D :	11.3 (+2.5, -3.9) 10.5 dB (+0.9, -1.8)
(average, 800 Hz to 12.5 kHz)	
Minimum Usable Frequency:	600 Hz
Minimum Recommended X-over Freq.:	800 Hz (with K-10 or ND-10 drivers)
On-axis Nominal SPL 4V / 1 m^E:	111 dB SPL (with ND-10 driver)
Nominal Throat Diameter:	1.5"
Material:	Injected Aluminium
Colour:	Black
Mechanical Connection of Driver:	Bolt-on Four 7 mm Ø clearance holes on 114 mm Ø circle
Dimensions (H x W x D):	344 x 237 x 157 mm (13.8 x 9.5 x 6.3 in)
Minimum Baffle Cutout:	310 x 203 mm (12.4 x 8.1 in)
Weight:	2.65 kg (5.9 lbs)
Shipping Weight:	3.55 kg (7.9 lbs)

^B Average of one-third octave band measures. One and one-third octave bands comply to ANSI S1.11-1986

^C Computed from two degree resolution vertical and horizontal one-third octave polars using sinusoidal weighting.

^D 10 log(Q).

^E On axis. IEC average 1 kHz to 8 kHz.

Polars were measured at two degree angular and 1/24th octave frequency resolution.

AUTOPOL, a platform consisting of custom and customized hardware and software, was used for the automated high-resolution acquisition and post-processing of directivity data. The digital storage of the data allows further processing and conversion to other software formats.

Modelling data can be found at <http://www.dasaudio.com/>.

DESCRIPTION

The D.A.S. BP-92 is a flat-front biplanar constant directivity horn that provides consistent lobe-free coverage. The 1.5" throat design minimizes distortion and provides consistent pattern control over a wider frequency range.

The horn is made out of injection molded aluminium, which provides additional heatsinking and thermal mass, increasing compression driver thermal power handling up to 80%.

Compact sized, it delivers a 90° horizontal and 60° vertical dispersion.

The high frequency rolloff shown in the frequency response overleaf is a characteristic of constant directivity horns that arises from the transducer's falling power response. When used as part of a passive system, it may be compensated at the input filter stage. When used fully active, generic processors will normally feature CD horn equalization options.

MOUNTING

The BP-92 can be mounted to enclosures by eight 5mm diameter screws.

The aluminium construction allows for front panel mounting without the need for compression driver support.

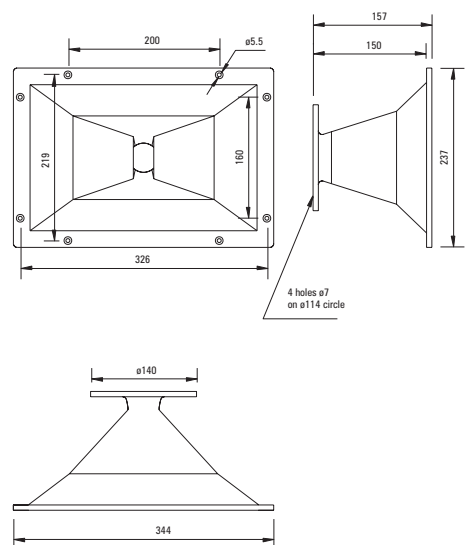

D.A.S.
Speakers

Frequency Response

Figure 1 shows the frequency response at 1 m of a BP-92/K-10 horn and driver set radiating to an anechoic environment and driven by a 4 V swept sine signal. Figure 4 shows the same for a BP-92/ND-10 horn and driver set. Grey curves show response with filter network shown below.

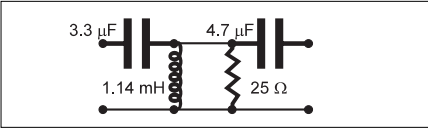

Impedance

Figure 2 shows impedance with frequency of a BP-92/K-10 horn and driver set. Figure 5 shows the same for a BP-92/ND-10 horn and driver set.

Distortion

Figure 3 shows the Second Harmonic Distortion (grey) and Third Harmonic Distortion (dotted) curves for a BP-92/K-10 horn and driver set at 11.5 V. Figure 6 shows the same for a BP-92/ND-10 horn and driver set at 11.5 V.

Beamwidth

Figure 7 shows the -3, -6 and -10 dB horizontal (solid) and vertical (dashed) beamwidth with frequency curves. -6 dB ones are shown with thicker traces for clarity.

Axial Directivity $Q(R_\theta)$ and D_i

Figure 8 shows the above characteristics with frequency. Thin continuous and dashed lines show partial horizontal and vertical characteristics, respectively.

Relative frequency responses

Figure 9 shows the relative frequency responses in 15 degree increments to half the nominal coverage angle.

NOTES. 1.Frequency response: referred to 1 m; low end obtained through the use of near field techniques; one-third octave smoothed for correlation with human hearing. 2.In practice, cable and connector impedance need to be added. 3.Harmonic distortion components are not plotted beyond 20 kHz; near-field techniques used. 4.Directivity characteristics plotted with respect to frequency are the average within the one-third octave bands of center frequencies noted by the marks at the bottom of the graphs, but are joined up for display purposes. All other characteristics plotted vs. frequency use 1/24th octave resolution. Regions of less than 1 dB below goal level and sharp notches may be ignored when calculating beamwidths. 5.Directivity factor and index were computed from two degree resolution vertical and horizontal polars using sinusoidal weighting. 6.Polars were acquired by placing the unit on a computer controlled turntable inside our anechoic chamber. Measurement distance was 4 m.

Product improvement through research and development is a continuous process at D.A.S. Audio. All specifications subject to change without notice.

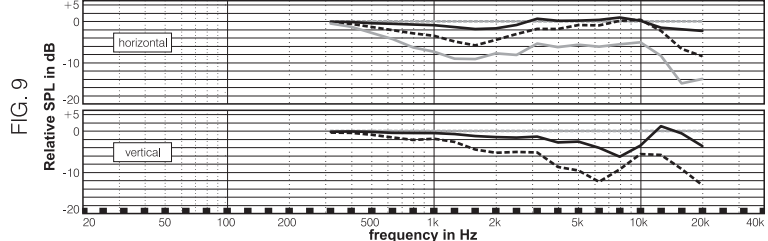
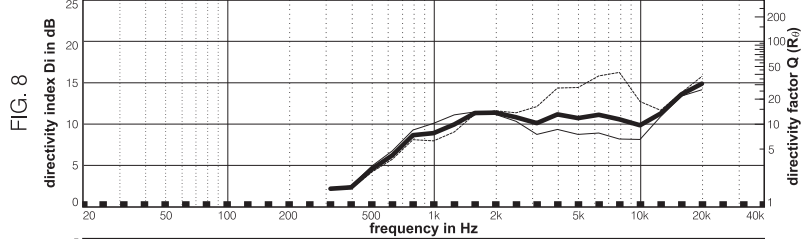
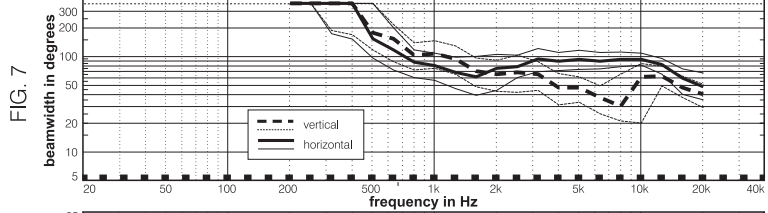
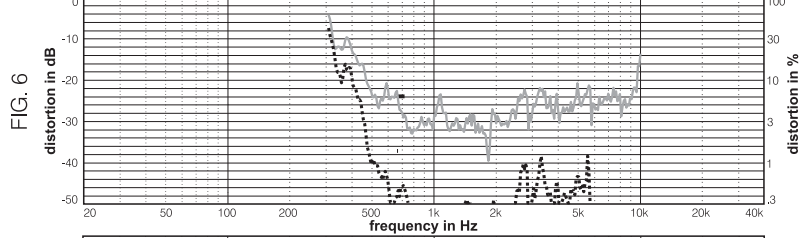
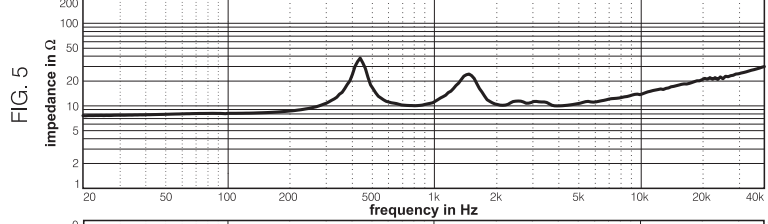
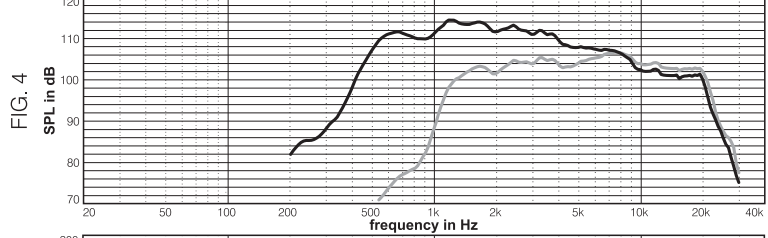
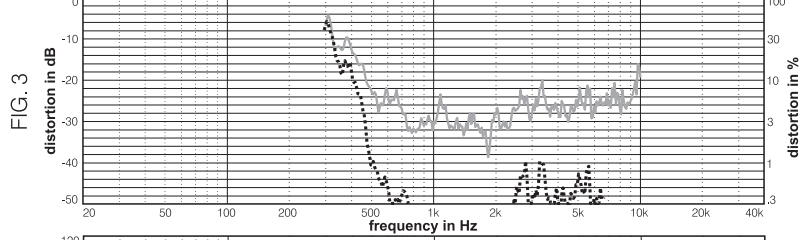
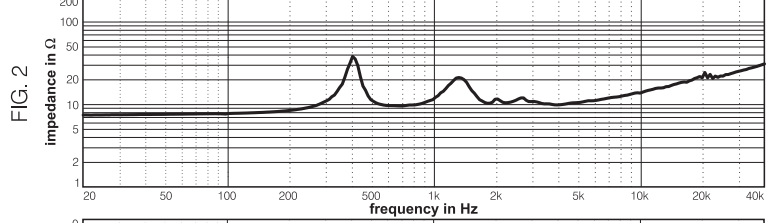
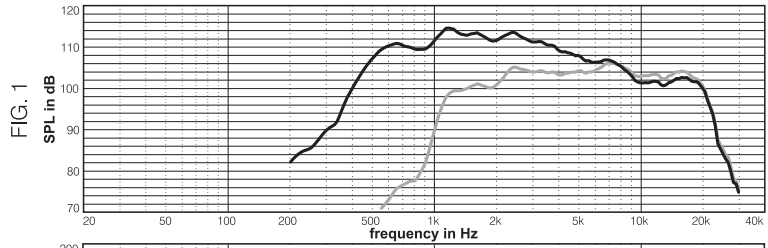

Polar Response

Figure 10 shows the third-octave band horizontal (solid) and vertical (dashed) polars for the indicated frequencies. Full scale is 50 dB, 5 dB per division.

FIG. 10

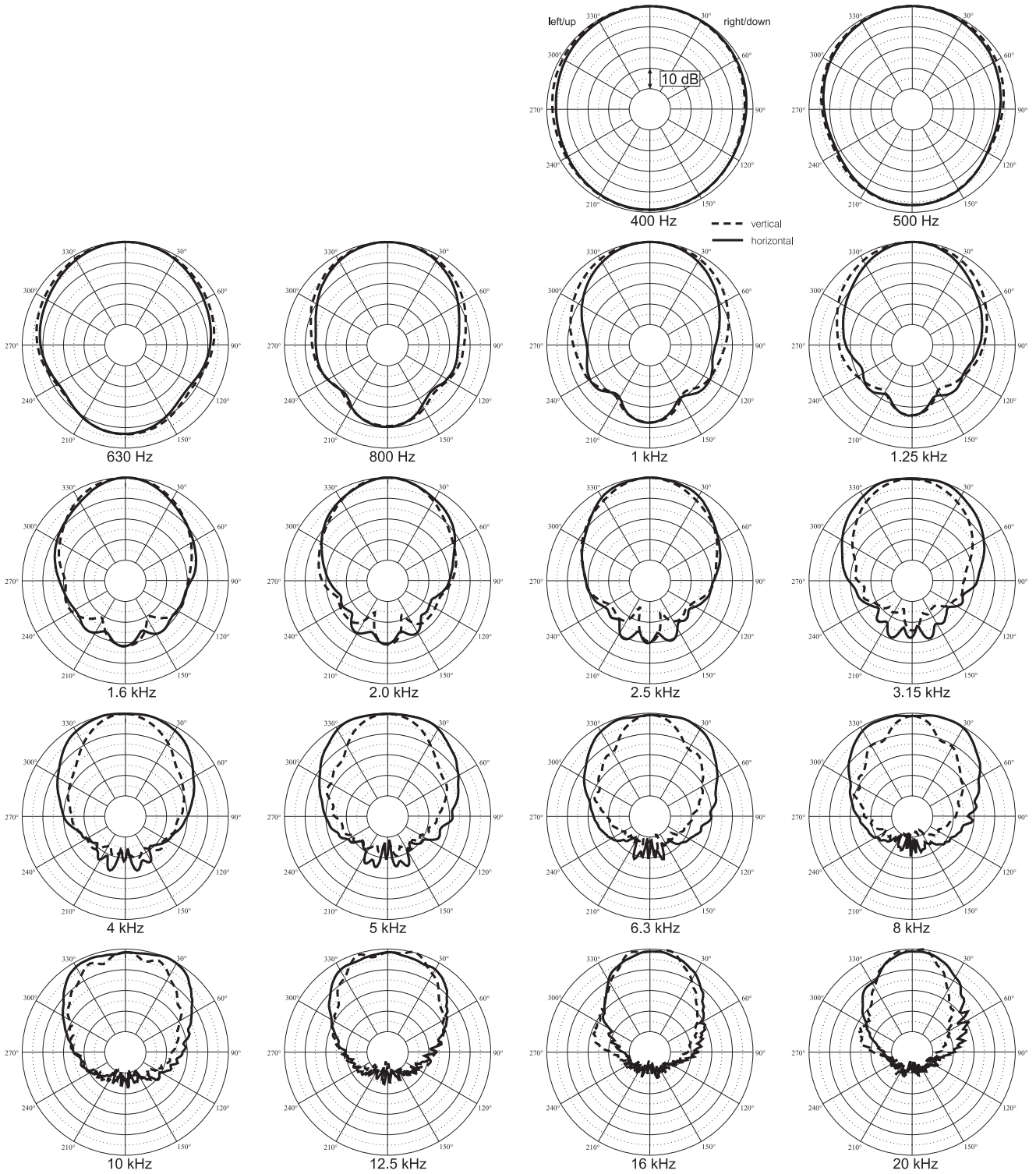

Directivity parameters for one-octave bands are given below:

	500 Hz	1 kHz	2 kHz	4 kHz	8 kHz	16 kHz
Horizontal -6 dB coverage angle	138°	72°	73°	92°	92°	69°
Vertical -6 dB coverage angle	169°	98°	68°	52°	38°	53°
Directivity Q(R _θ)	3.5	9.2	13.1	11.6	11.7	18.5
D _i	5.4 dB	9.7 dB	11.2 dB	10.6 dB	10.7 dB	12.7 dB



D.A.S. Audio, S.A.

C/. Islas Baleares, 24 - 46988 Fuente del Jarro - Valencia, SPAIN
Tel. 96 134 0525 - Tel. Intl. +34 96 134 0860 - Fax. 96 134 0607 - Fax. Intl. +34 96 134 06 07

**D.A.S. Audio of
America, Inc.**

Sunset Palmetto Park 6816 NW 77th Court, Miami, FL
33166, U.S.A. Tel. 305 436 0521 - Fax. 305 436 0528

<http://www.dasaudio.com>