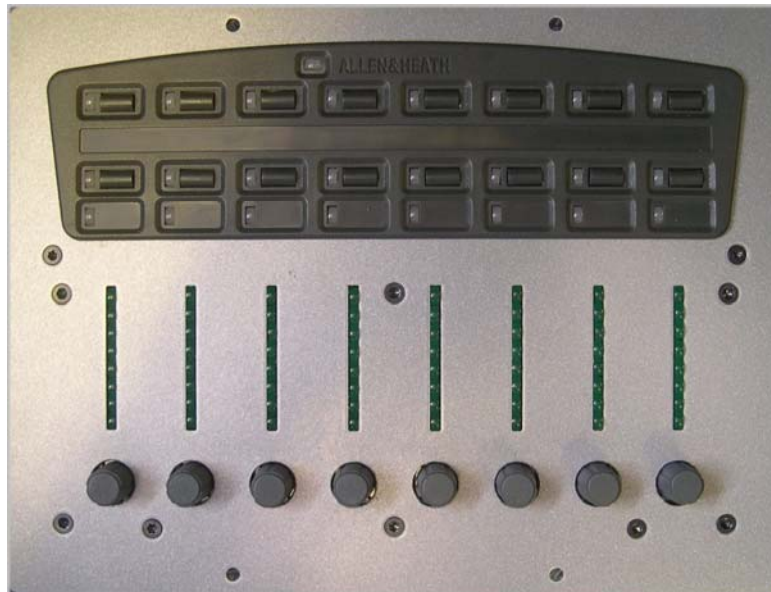

User Guide

Introduction The **PL-10** adds to the extensive range of remote control devices available for the **iDR-4** and **iDR-8** audio mix processor systems. It offers an alternative to the **PL-6** fader controller with the advantage that user settings can be stored and recalled without the need to physically move the controls to the new settings.

The **PL-10** is part of the Allen & Heath **PL Series** of wall plates and remote controllers. It can be mounted into a plinth or custom furniture, or used free standing. Template cutting details are provided for custom application. The **PL-10** interfaces with the Allen & Heath PL-Anet serial port. Multiple **PL-10** units can be daisy chained together along with other PL-Anet devices using CAT5 cable. A terminator is provided for plugging into the last unit in the chain. For information on the full range of **PL** products available visit <http://www.allen-heath.com>. The **PL-10** control and indicator functions are programmed using the iDR System Manager software. Space is provided next to the controls for custom labelling. The **PL-10** is ideal as a remote mix controller, for example as a simple operator controlled mix panel in an installed sound system, or as a personal musicians on-stage mix controller for in-ear monitors. The installer can program the unit according to the requirements of the application, providing the degree of control needed by the day to day operator.

8 Rotary Encoders can be configured individually for continuous input, output, group, crosspoint level control or monitor level. Minimum and maximum ranges can be set. Each rotary encoder has 8 LEDs displaying the control position. **16 Switches**, arranged as two per rotary encoder, can be configured as combinations of level up/down, mute toggle, polarity toggle, audio monitor select, or preset recall. **24 LED indicators**, arranged as three per fader, can be configured as combinations of 3 colour signal meters, mute status, channel on indication, level sensing or preset related 3 colour LED indication. Controls can be disabled if not required. A single 3 colour **Status LED** displays PL-Anet power and communication status. **Custom labels** can be fitted into the recessed areas provided (13 x 7mm). Recommended label height is 6mm.

NOTE: The **PL-10** is only compatible with Allen & Heath iDR System manager software version **3.40** or above. The latest version of iDR System manager software can be downloaded free from the Allen & Heath website:

www.allen-heath.com



This product complies with the European Electromagnetic Compatibility directives 89/336/EEC & 92/31/EEC.

NOTE: Any changes or modifications to the equipment not approved by Allen & Heath could void the compliance of the equipment. Whilst we believe the information in this guide to be reliable we do not assume responsibility for inaccuracies. We also reserve the right to make changes in the interest of further product development.

Copyright© 2004 Allen & Heath Ltd. All rights reserved.

IMPORTANT :

Observe the local standards which may apply to the installation regarding the grade of cable and installation methods.



Do not install the equipment where it is subject to moisture, heat, vibration or excessive movement.



Connect this equipment to the Allen & Heath PL-Anet port only. Test for correct wiring and installation before switching the equipment on.

Number of devices The maximum number of PL devices that can be connected depends on their type, cable lengths and PL-Anet Bus Speed. Up to 18x PL-10 devices may be connected in an iDR system with the half speed PL-Anet Bus setting. Fewer devices may be connected if long distances, full bus speed or other PL types are involved. Long distances up to 300m (1000'), and star point connection are possible if the optional PL-9 PL-Anet hub is used. Before starting, it is important that you refer to the PL Combinations Calculator spreadsheet available with the iDR software.

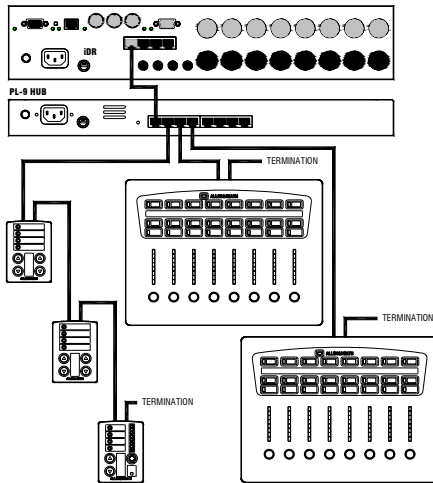

PL-Anet is the proprietary Allen & Heath system for daisy chaining remote controllers. It is an RS485 serial connection that uses CAT5 STP cable to communicate between devices over long distances. It requires a terminator at the last unit in the chain. PL-Anet only works with Allen & Heath PL devices. The connection includes +20V DC to power the connected devices. The iDR-8 port is shown here.

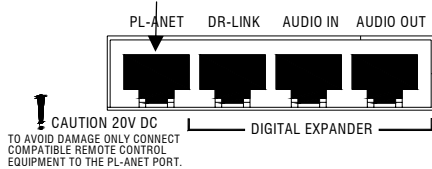

Mounting into furniture Cutting template details are shown here for mounting the PL-10 into a plinth or other furniture. Secure the unit in place using 4x fixing screws up to 3.5mm diameter.

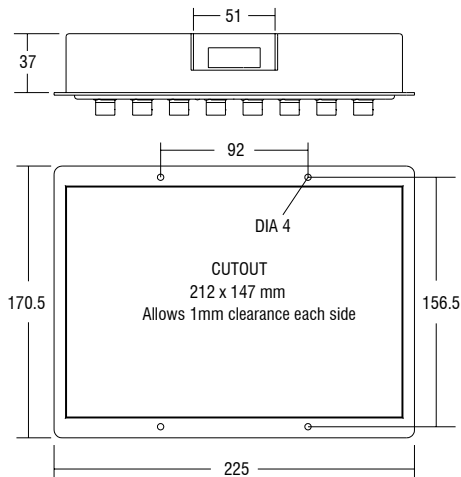

Grounding The exposed metal panels are grounded through the PL-Anet cable shield. There are no dangerous voltages inside.

PL-Anet connections Underside RJ45 ports are provided for connecting to PL-Anet. These are recessed so that the cables can be hidden from view. The IN port connects to the previous unit in the chain. The OUT port connects to the next unit, or end of chain termination. Use flame retardant CAT5 STP (shielded twisted pair) RJ45 cables.

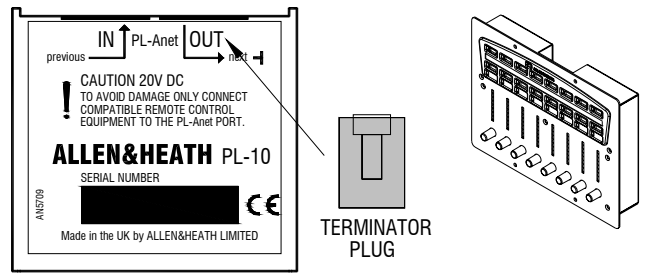

End of chain termination As with any RS485 system, the last PL device needs to have a terminating resistor fitted to its output port. The PL-10 is shipped with an RJ45 terminator plug with this resistor built in. Plug the terminator into the last unit in the PL-Anet chain. If the PL-10 is the only unit connected make sure the terminator is plugged into its output port.

Testing the wiring Before powering up the system make sure all the wiring is inspected and continuity tested. This is important as wiring errors may result in damage to the equipment.

Powering up the PL system Ensure that the iDR PL-Anet port is active. Its green 'active' LED should be lit. If not, use the iDR System Manager software Communications Option menu to activate the port. Plug in the PL-Anet cable. The screen will display icons on the right hand toolbar for each PL device it recognises. Check that the PL-10 front panel status LED displays green. If red or yellow is displayed then check for wiring or equipment faults.

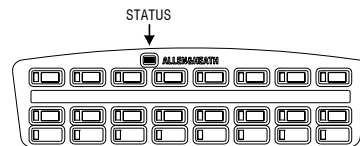

Configuring the controls The rotary encoders, switches and LED indicators are configured using the iDR System Manager software. Note that the LEDs are 3-colour and can display green, red, yellow or off. Refer to the Help file that comes with the software.

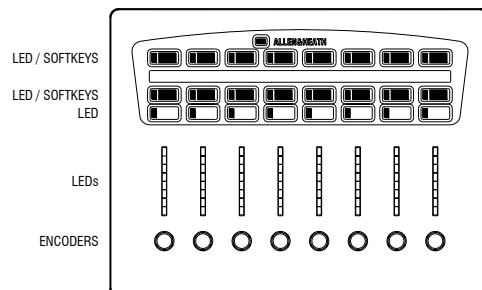

Further information Visit the Allen & Heath web site for information on the full PL product range www.allen-heath.com. If further assistance is required please contact Allen & Heath technical support.