

d.2 PRO

2-Channel DJ Production Console with FireWire

OWNER'S MANUAL

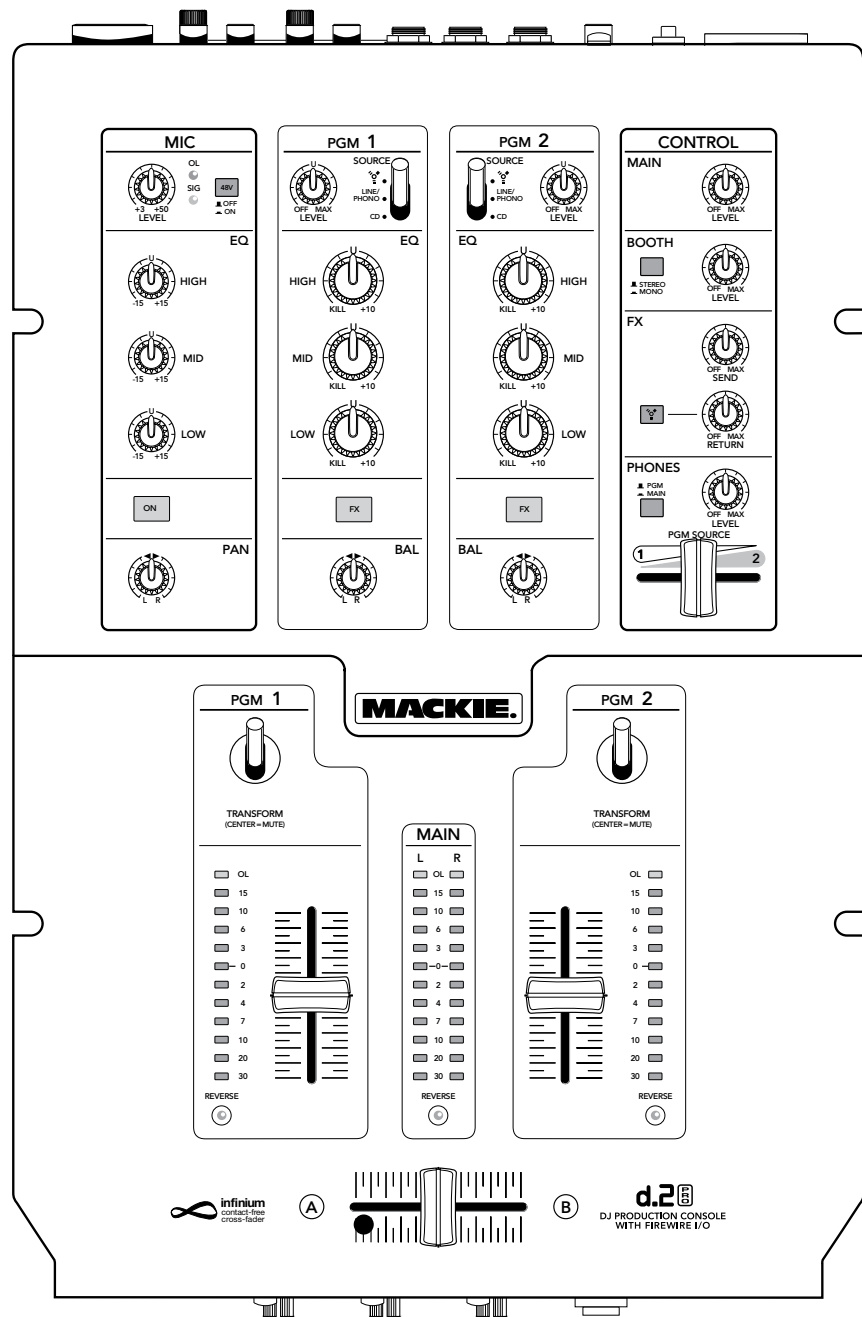

MACKIE®

Important Safety Instructions

1. Read these instructions.
2. Keep these instructions.
3. Heed all warnings.
4. Follow all instructions.
5. Do not use this apparatus near water.
6. Clean only with a dry cloth.
7. Do not block any ventilation openings. Install in accordance with the manufacturer's instructions.
8. Do not install near any heat sources such as radiators, heat registers, stoves, or other apparatus (including amplifiers) that produce heat.
9. Do not defeat the safety purpose of the polarized or grounding-type plug. A polarized plug has two blades with one wider than the other. A grounding-type plug has two blades and a third grounding prong. The wide blade or the third prong are provided for your safety. If the provided plug does not fit into your outlet, consult an electrician for replacement of the obsolete outlet.
10. Protect the power cord from being walked on or pinched particularly at plugs, convenience receptacles, and the point where they exit from the apparatus.
11. Only use attachments/accessories specified by the manufacturer.
12. Use only with a cart, stand, tripod, bracket, or table specified by the manufacturer, or sold with the apparatus. When a cart is used, use caution when moving the cart/apparatus combination to avoid injury from tip-over.
13. Unplug this apparatus during lightning storms or when unused for long periods of time.
14. Refer all servicing to qualified service personnel. Servicing is required when the apparatus has been damaged in any way, such as power-supply cord or plug is damaged, liquid has been spilled or objects have fallen into the apparatus, the apparatus has been exposed to rain or moisture, does not operate normally, or has been dropped.
15. This apparatus shall not be exposed to dripping or splashing, and no object filled with liquids, such as vases or beer glasses, shall be placed on the apparatus.
16. This apparatus has been designed with Class-I construction and must be connected to a mains socket outlet with a protective earthing connection (the third grounding prong).
17. This apparatus has been equipped with an all-pole, rocker-style AC mains power switch. This switch is located on the rear panel and should remain readily accessible to the user.
18. This apparatus does not exceed the Class A/Class B (whichever is applicable) limits for radio noise emissions from digital apparatus as set out in the radio interference regulations of the Canadian Department of Communications.

ATTENTION — *Le présent appareil numérique n'émet pas de bruits radioélectriques dépassant les limites applicables aux appareils numériques de class A/de class B (selon le cas) prescrites dans le règlement sur le brouillage radioélectrique édicté par les ministere des communications du Canada.*

19. Exposure to extremely high noise levels may cause permanent hearing loss. Individuals vary considerably in susceptibility to noise-induced hearing loss, but nearly everyone will lose some hearing if exposed to sufficiently intense noise for a period of time. The U.S. Government's Occupational Safety and Health Administration (OSHA) has specified the permissible noise level exposures shown in the following chart.

According to OSHA, any exposure in excess of these permissible limits could result in some hearing loss. To ensure against potentially dangerous exposure to high sound pressure levels, it is recommended that all persons exposed to equipment capable of producing high sound pressure levels use hearing protectors while the equipment is in operation. Ear plugs or protectors in the ear canals or over the ears must be worn when operating the equipment in order to prevent permanent hearing loss if exposure is in excess of the limits set forth here.

Duration Per Day In Hours	Sound Level dBA, Slow Response	Typical Example
8	90	Duo in small club
6	92	
4	95	Subway Train
3	97	
2	100	Very loud classical music
1.5	102	
1	105	Dave screaming at Steve about deadlines
0.5	110	
0.25 or less	115	Loudest parts at a rock concert

WARNING — To reduce the risk of fire or electric shock, do not expose this apparatus to rain or moisture.

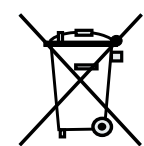

PORTABLE CART WARNING



Carts and stands - The Component should be used only with a cart or stand that is recommended by the manufacturer. A Component and cart combination should be moved with care. Quick stops, excessive force, and uneven surfaces may cause the Component and cart combination to overturn.

CAUTION AVIS

**RISK OF ELECTRIC SHOCK
DO NOT OPEN**

**RISQUE DE CHOC ELECTRIQUE
NE PAS OUVRIR**

CAUTION: TO REDUCE THE RISK OF ELECTRIC SHOCK DO NOT REMOVE COVER (OR BACK) NO USER-SERVICEABLE PARTS INSIDE REFER SERVICING TO QUALIFIED PERSONNEL

ATTENTION: POUR EVITER LES RISQUES DE CHOC ELECTRIQUE, NE PAS ENLEVER LE COUVERCLE. AUCUN ENTRETIEN DE PIECES INTERIEURES PAR L'USAGER. CONFIEZ L'ENTRETIEN AU PERSONNEL QUALIFIE.

AVIS: POUR EVITER LES RISQUES D'INCENDIE OU D'ELECTROCUTION, N'EXPOSEZ PAS CET ARTICLE A LA PLUIE OU A L'HUMIDITE

The lightning flash with arrowhead symbol within an equilateral triangle is intended to alert the user to the presence of uninsulated "dangerous voltage" within the product's enclosure, that may be of sufficient magnitude to constitute a risk of electric shock to persons.

Le symbole éclair avec point de flèche à l'intérieur d'un triangle équilatéral est utilisé pour alerter l'utilisateur de la présence à l'intérieur du coffret de "voltage dangereux" non isolé d'ampleur suffisante pour constituer un risque d'électrocution.

The exclamation point within an equilateral triangle is intended to alert the user of the presence of important operating and maintenance (servicing) instructions in the literature accompanying the appliance.

Le point d'exclamation à l'intérieur d'un triangle équilatéral est employé pour alerter les utilisateurs de la présence d'instructions importantes pour le fonctionnement et l'entretien (service) dans le livret d'instruction accompagnant l'appareil.

Contents

SAFETY INSTRUCTIONS	2	28. MID EQ	13
INTRODUCTION	4	29. LOW EQ	13
GETTING STARTED.....	5	30. FX SWITCH	13
HOOKUP DIAGRAMS.....	6	31. BAL.....	13
REAR PANEL FEATURES	10	CONTROL SECTION.....	14
1. MIC INPUT	10	32. MAIN LEVEL	14
2. CD INPUTS	10	33. BOOTH LEVEL.....	14
3. LINE/PHONO INPUTS	10	34. STEREO/MONO.....	14
4. LINE/PHONO SWITCH	10	35. FX SEND LEVEL.....	14
5. GND TERMINAL.....	10	36. FX RETURN LEVEL.....	14
6. STEREO FX SEND	10	37. FIREWIRE FX RETURN.....	14
7. STEREO FX RETURN	10	38. PHONES LEVEL	14
8. BOOTH OUTPUTS.....	10	39. PGM/MAIN	14
9. XLR MAIN OUTS.....	11	40. PGM SOURCE CUE CROSSFADER.....	14
10. LINE/MIC SWITCH.....	11	PROGRAM OUTPUT SECTION.....	15
11. RCA MAIN OUTS	11	41. TRANSFORM	15
12. LIVE/RECORD SWITCH	11	42. PROGRAM FADER.....	15
13. POWER SWITCH.....	11	43. PGM LEVEL METERS.....	15
14. POWER RECEPTACLE	11	44. REVERSE LED.....	15
15. FIREWIRE.....	11	45. MAIN LEVEL METERS	15
MIC INPUT SECTION.....	12	46. REVERSE LED.....	16
16. MIC LEVEL.....	12	47. CROSSFADER.....	16
17. MIC SIGNAL LED.....	12	FRONT PANEL FEATURES	17
18. MIC OL LED	12	48. CONTOUR	17
19. 48V PHANTOM POWER SWITCH.....	12	49. REVERSE.....	17
20. HIGH EQ	12	50. HEADPHONES JACK	17
21. MID EQ	12	APPENDIX A: SERVICE INFORMATION.....	18
22. LOW EQ	12	APPENDIX B: CONNECTIONS.....	20
23. ON SWITCH.....	12	APPENDIX C: TECHNICAL INFO.....	21
24. PAN.....	12	APPENDIX D: TRANSFORM SWITCH ROTATION AND FADER REPLACEMENT	24
PROGRAM INPUT SECTION	13	APPENDIX E: FIREWIRE	26
25. LEVEL.....	13	D.2 PRO LIMITED WARRANTY	31
26. SOURCE SELECT	13		
27. HIGH EQ	13		

Need help with your new d.2 Pro DJ Mixer?

- Visit www.mackie.com and click Support to find: FAQs, manuals, addendums, and user forums.
- Email us at: techmail@mackie.com.
- Telephone 1-800-898-3211 to speak with one of our splendid technical support representatives, (Monday through Friday, from 7 a.m. to 5 p.m. PST).

Introduction

Thank you for choosing a Mackie d.2 Pro DJ production console for scratch and club DJs. It contains all your favorite features in a scratch mixer, along with significant extras that you will come to appreciate.

The d.2 was the first DJ mixer made by Mackie. The d.2 Pro builds upon the success of the d.2, making it a truly professional product with the high-end performance you've come to expect from Mackie. Features like our "built like a tank" construction, premium analog circuitry, infinium™ contact-free crossfader, FireWire™ connectivity as standard, and "Planet Earth" power supply add value to the d.2 Pro not found in any other scratch mixer in its class.

FEATURES

- 2 Stereo program channels with FireWire, CD and line/phono inputs.
- Built-in FireWire 13x6 interface provides easy input from your computer to the program channels and FX return, and easy outputs to the computer from: program channels (direct and post-EQ), microphone, FX bus and the main mix. It has 24-bit resolution, and 44.1, 48, 88.2, and 96 kHz sample rates.
- Sends the crossfader position over FireWire to your computer via a MIDI controller message.
- Premium VCA-based design offers extremely smooth fades and crossfades with very low distortion characteristics.
- Program faders and crossfader have variable contour curves and reverse switches.
- 3-Band EQ on each channel, with kill position and backlit blue knobs.
- User-replaceable optical crossfader from Infinium, with easily adjustable tension and contour.
- Mackie mic preamp with 3-band EQ for pro-quality vocals through the d.2 Pro.
- Mackie phono preamplifiers on each channel.
- XLR main outputs with mic/line switch (mic position allows stage connections with no D.I. boxes required).
- RCA main outs with live/record switch (record position delivers a pre-main out).
- Ultra bright main meters plus individual program meters for cueing and beat matching.
- Separate mono/stereo switchable booth output on balanced TRS connectors.
- Stereo FX loop for outboard effects.
- Mighty strong construction to withstand the rigors of DJ work.
- Integrated rack ears (Odyssey Battle Bridge™ compatible).
- Removable top panel provides access to the rotatable transform switches and to the user-replaceable faders.
- "Planet Earth" power-supply operates on voltages between 100 and 240 VAC.
- Standard IEC power receptacle and power cord.
- Includes Tracktion, our professional, easy-to-use, totally-amazing music production software.
- Certified for use with Tracktor® Scratch DJ production software for live scratching.

HOW TO USE THIS MANUAL

Please read the safety instructions on page 2 first. The getting started guide on page 5 will help you get the mixer set up fast so you can start using it right away. Right after that are the ever popular hook-up diagrams that show you some typical setups.

The features section describes every knob, button, and connection point on the d.2 Pro, roughly following the signal flow through the mixer from top to bottom. For more information about a feature, locate its number in the appropriate illustration, and find it in the nearby paragraphs.



This icon marks information that is critically important or unique to the d.2 Pro. For your own good, read them and remember them.



This icon leads you to in-depth explanations of features and practical tips. They usually have some valuable nuggets of information.

Appendix A shows service and repair information. Appendix B is a section on connectors. Appendix C shows the specs and a block diagram. Appendix D shows how to reposition the transform switches, and replace the faders. Appendix E shows details of the FireWire interface.

Please write your serial number here for future reference (i.e., insurance claims, tech support, return authorization, etc.)

Purchased at:

Date of purchase:

Getting Started

READ THIS PAGE!!

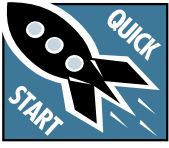

Even if you never read manuals, please read and digest the safety instructions on page 2, and this page before you begin using the d.2 Pro mixer.

Zero the Controls

1. Turn the rear panel power switch off.
2. Turn down the level controls for mic, pgm 1 and pgm 2, and center all EQ, pan, and bal controls.
3. Set all push button switches to their “out” positions.
4. In the control section (right hand side), turn all the rotary knobs down, and the switches out.
5. Set the program faders fully down.
6. On the front panel, set the reverse switches out.
7. Center the crossfader.

Connections

If you already know how you want to connect the d.2 Pro, go ahead and connect the inputs and outputs the way you want them. If you just want to get sound through the d.2 Pro, follow these steps:

1. Plug a signal source to the d.2 Pro. This could be a:
 - Microphone into the mic input
 - Turntable into a phono input (push in the rear panel line/phono switch)
 - Line-level source such as a CD player into the phono input (push out the line/phono switch)
 - Line-level source such as a CD player into a CD input.
2. If you are using the phono input, make sure you set the line/phono switch correctly.
3. Connect cords from the d.2 Pro's main outs (XLR or RCA connectors on the rear panel) to your powered speakers or amplifier.
4. Plug in the detachable linecord, connect it to a live AC outlet, and turn on the d.2 Pro's power switch.
5. If you have powered speakers, turn them on. Otherwise, hook up your speakers to the amp and turn it on. Adjust your powered speaker or amplifier level controls to however the manufacturer recommends. (This is usually all the way up.)

Set the Levels

To set the level controls, it's not even necessary to hear what you're doing at the outputs of the mixer. If you want to listen while you work, plug headphones into the phones jack on the front panel, then set the phones knob up a little.

1. Select the input using the source switch.
2. Play something into the selected input. Be sure that the volume of the input source is the same as it would be during normal use. If it isn't, you might have to readjust these levels during the middle of a set.
3. Center the transform switch. There will be no output, but the program meter will still work.
4. Adjust the channel's rotary level control so that the LEDs on the program meter stay around “0” and +3, and never go higher than “+6.”
5. Apply some EQ if needed, (return to step 4 if you do, just to check the levels are still OK).
6. Repeat for the other channel (if you want to).

Set the Mic Levels

1. To level the microphone input, keep the on button off, and talk or sing at your highest expected level.
2. Adjust the mic level until the OL LED next to it only comes on occasionally.

Instant Mixing

1. To get sound out of the speakers, press the transform switch up (the latched position), turn up the program fader, and slowly rotate the main control to a comfortable listening level.
2. Sing and play. You're a star! Bring in the other channel, play with the crossfader, and generally have fun.

FireWire

1. See Appendix E, page 26 for details of getting started with FireWire.

Other Nuggets of Wisdom

- Always turn down the main, booth, and phone knobs before making any connections.
- When you shut down your equipment, turn off the amplifiers first. When powering up, turn on the amplifiers last.

Hookup Diagrams

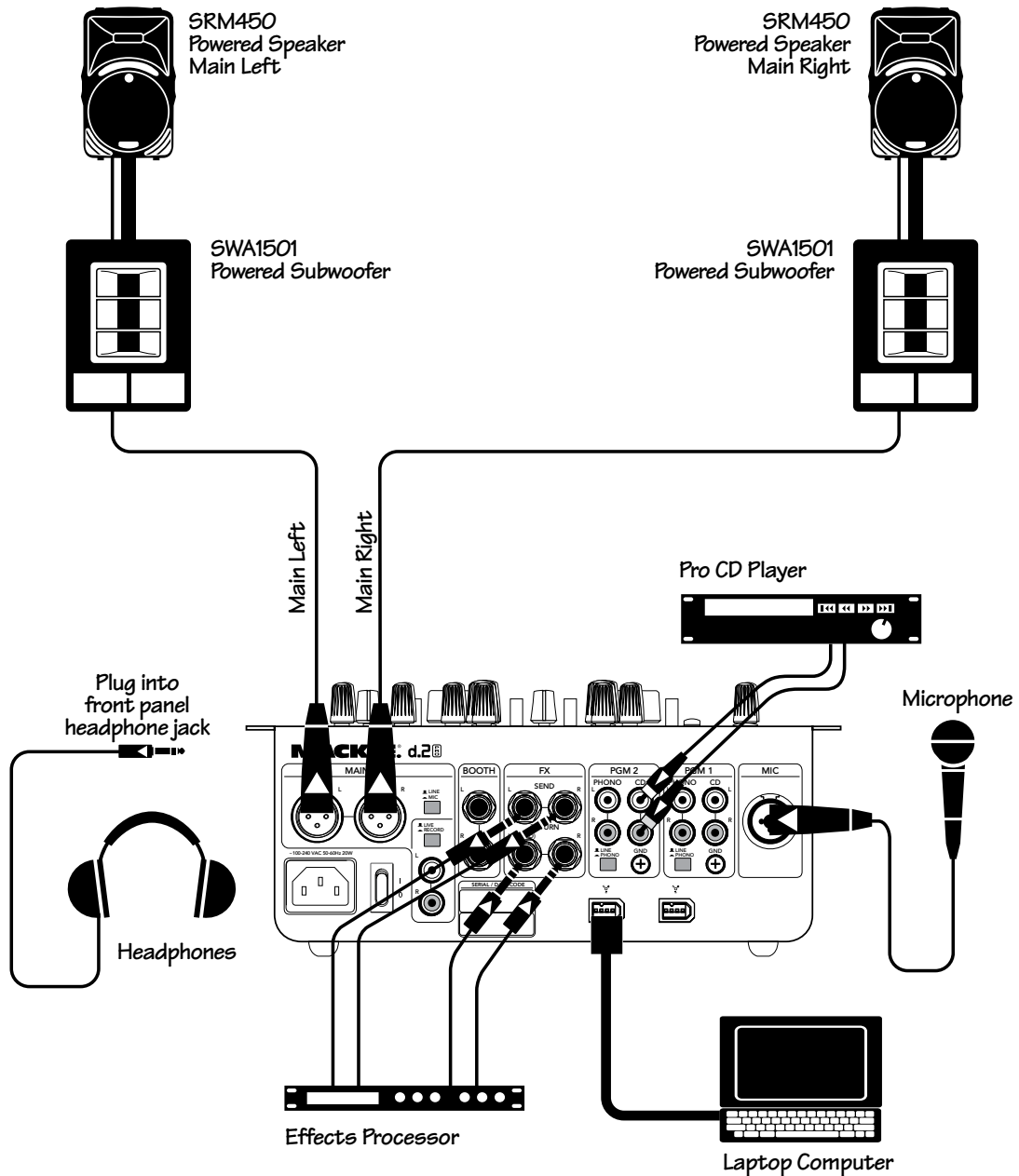

This diagram shows a CD player and microphone connected, with an effects device in the FX loop, and a laptop attached. Various popular DJ software such as Traktor™, PCDJ™, and MixVibes™, can be used with the d.2 Pro via the Fire Wire connection. The main wonder mix can be recorded with software such as Tracktion.

Mobile DJ System: Rental, or Wedding

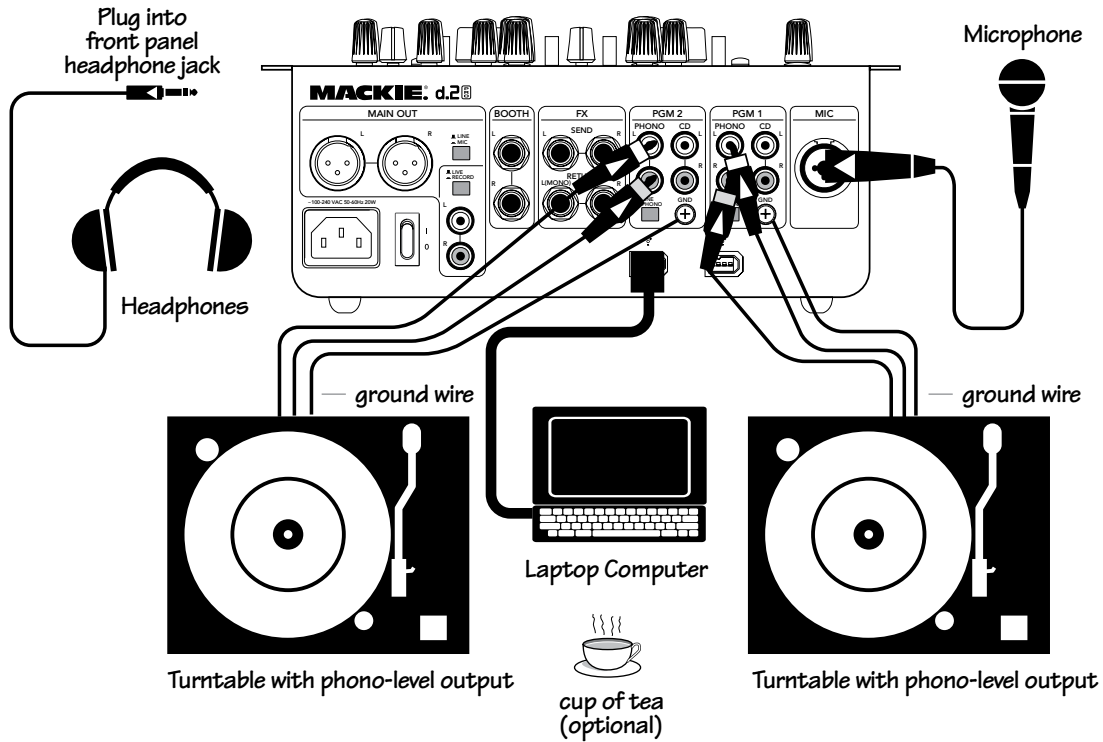

This diagram shows two turntables and a microphone, with the laptop connected for recording and playing.

The output from various software, such as Reason™, Live™, Traktion™, and Logic™ can be sent to the program channels for mixing, and the final mix recorded for broadcast/podcasting. This is also a nice setup for recording your record collection for posterity.

You could play timecode vinyl and set up a virtual turntable on the laptop. In this way, you can use the physical turntable to control any musical tracks added to the virtual turntable. (See page 27 for more timecode information.)

Radio Show Recording/Podcasting/having a good old time

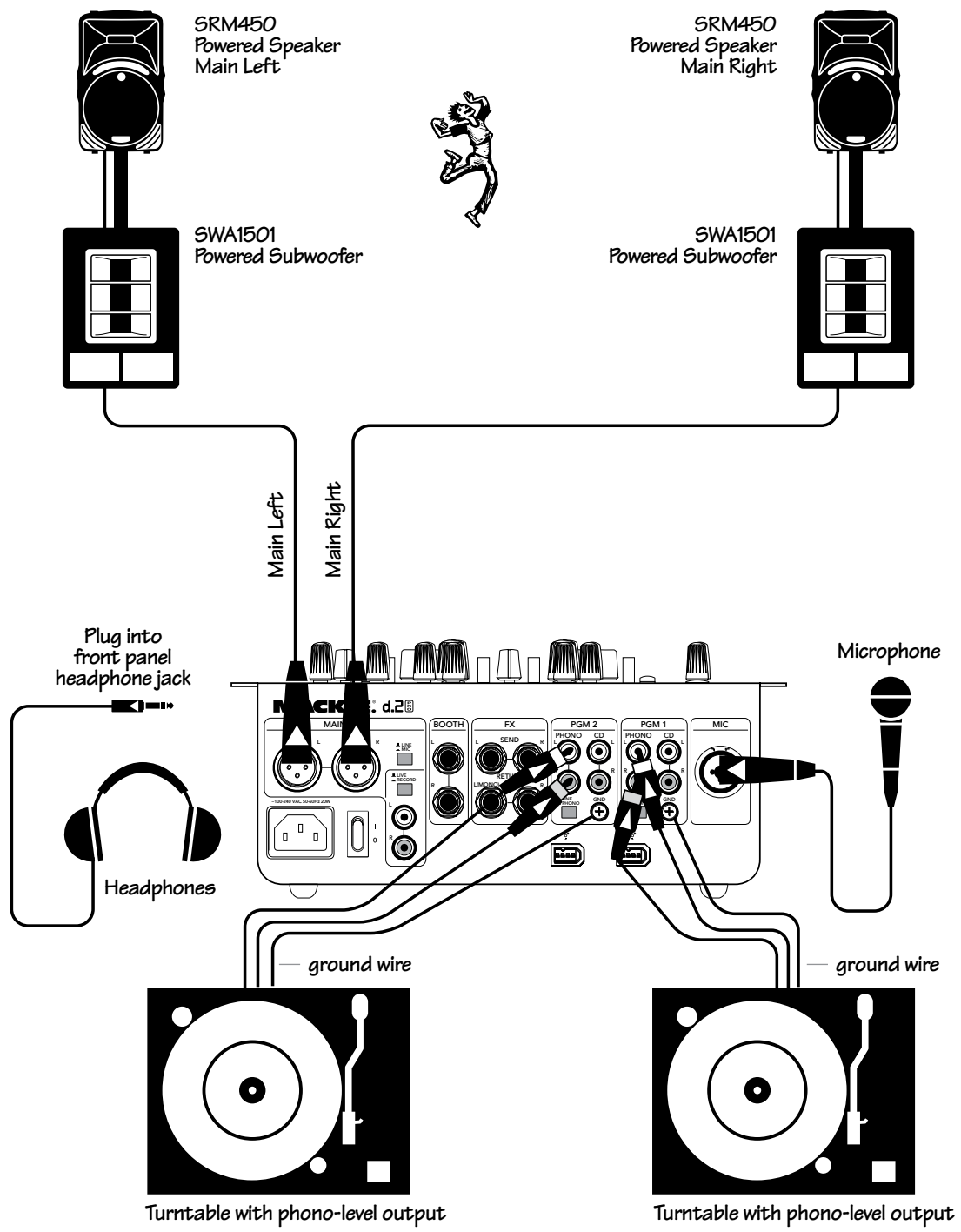

Here we show the d.2 Pro being used at wild Mackie parties. Who said that project managers couldn't dance?

Two-Turntable Portable System

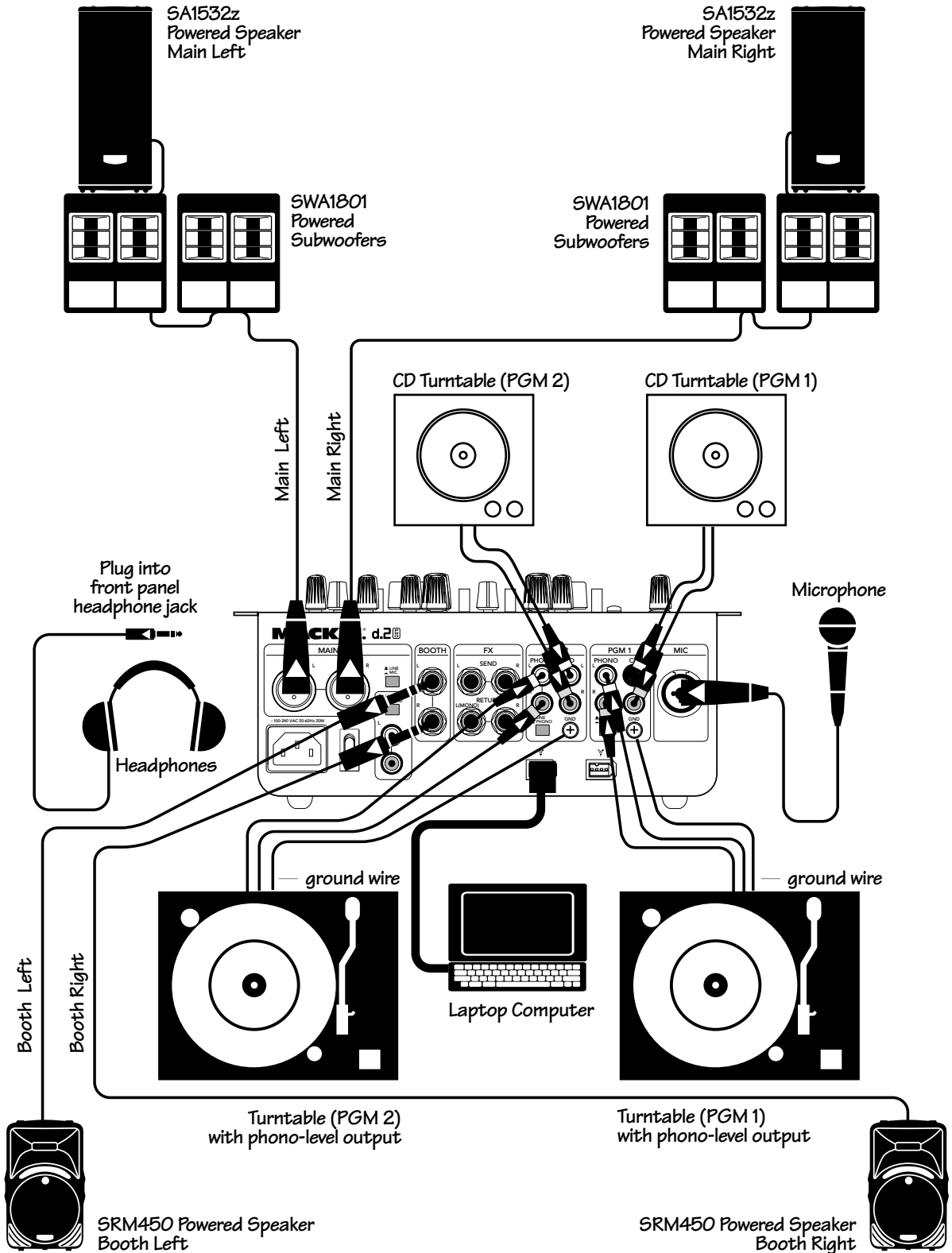

Here the d.2 Pro inputs are fed with conventional sources, and the FireWire connection is used to record the master mix output to computer, using the included Traktion software (for example). The program channels can also be recorded to the computer separately, for added flexibility later in working with the recorded performance. The source select switch can be used to quickly select either the turntable, CD deck, or FireWire as the input to program 1 or 2, without the need for repatching.

Note: The conventional turntables can be used with timecode vinyl, even when they are not selected manually with the d.2 Pro source select switches.

Club System

Rear Panel Features

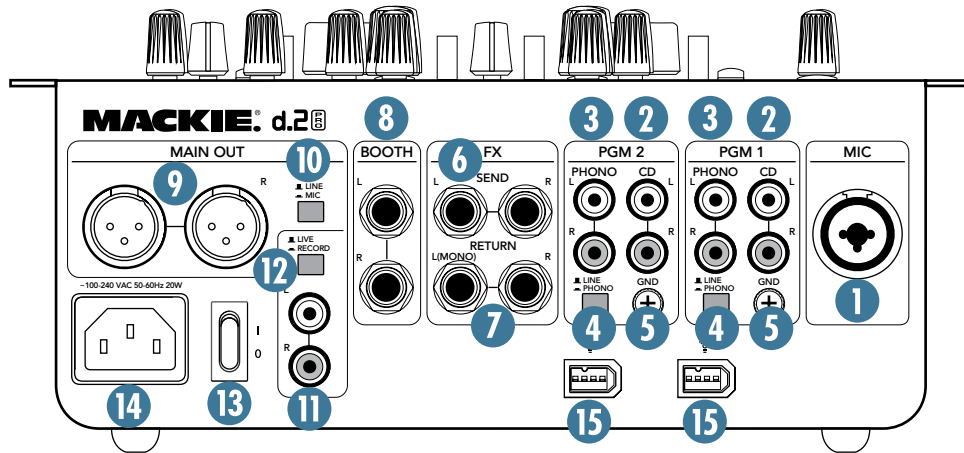

1. MIC Input

This is a Neutrik “combo” input connector that accepts either a balanced male XLR connector or a 1/4" balanced or unbalanced connector. Professional mics usually have XLR connectors, while consumer or semi-pro mics often have 1/4" connectors.

The mic input signal is routed through the mic input section, mic EQ, and then to the main mix bus.

2. CD Inputs

These RCA jacks accept a stereo line-level signal from a CD player or other line-level playback device, such as an MP3 player.

3. LINE/PHONO Inputs

These RCA jacks accept a stereo phono-level signal from a turntable (when the line/phono [4] switch is pushed in), or from a line-level playback device such as a CD player or MP3 player (when the line/phono switch is out). Check that your turntable has a phono-level output and a moving-magnet cartridge.

4. LINE/PHONO Switch

If you connect a turntable with phono-level outputs to the line/phono inputs [3], push this switch in to select the phono-level input stage, which includes an RIAA preamp for proper re-equalization of the incoming phono signal.

If you are connecting a line-level playback device like a CD or MP3 player, leave this switch out to select the line-level preamp.



Do not press it in if you have a line-level signal connected.

5. GND Terminal

These terminals are provided to connect a ground wire from your turntable(s) to the d.2 Pro. Most turntables provide a ground wire to connect to the preamp for the purpose of eliminating “hum” in the audio signal. Simply turn the ground terminal on the d.2 Pro counter-clockwise to loosen it, wrap the end of the ground wire clockwise around the terminal, and hand-tighten the ground terminal for a secure ground connection.

6. Stereo FX SEND

These 1/4" TRS jacks provide a balanced line-level output signal from the stereo FX Send bus. Use these to connect to the inputs of an external effects processor. You can also use an unbalanced 1/4" TS connector.

7. Stereo FX RETURN

These 1/4" TRS jacks accept a balanced line-level signal from an external effects processor. They will also accept an unbalanced 1/4" TS connector.

If you are using a stereo effects processor, connect its left and right outputs to the corresponding left and right FX return jacks. If it is a mono effects processor, connect its output signal to the left FX return jack, and it will appear on both the left and right main mix bus.

8. BOOTH Outputs

These 1/4" TRS jacks provide a balanced line-level signal from the main mix bus, prior to the rotary main level control [32]. Use these to connect to a pair of powered monitor speakers (or to the inputs of an amplifier powering the monitor speakers in the booth). If you only have one monitor speaker, just use one of the booth outputs and push in the booth stereo/mono switch [34] in the control section on the top panel.

9. XLR MAIN OUTS

These male XLR connectors provide a balanced mic- or line-level signal from the main level control [32]. The line/mic switch [10] determines if it is a mic-level or line-level output. Connect these to the balanced inputs of the active speakers, or power amplifier(s) powering your main speakers.

If you are connecting the d.2 Pro main out to an unbalanced input, use the RCA main outs [11] instead.



Balanced connections offer better immunity to external noise (specifically, hum and buzz) than unbalanced connections. Because of this, it is the preferred interconnect method, especially in cases where very long lengths of cable are being used. A long unbalanced cable carries with it more opportunity for noise to get into the system — having balanced cables means very little noise will enter the system. If you must use an unbalanced connection, keep the cable length to 10 feet or less (3 meters).

10. LINE/MIC Switch

If you are connecting the XLR main outs [9] to line-level inputs like a power amplifier's inputs, leave this switch out, in the line position.

If you are using the d.2 Pro as a submixer and connecting the XLR main outs to the mic inputs of another mixer, push this switch in to the mic position. This inserts a 30 dB pad to reduce the output signal to a mic level. This feature allows you to connect the d.2 Pro output directly to a snake without using direct boxes.

11. RCA Main Outs

These RCA connectors provide an unbalanced line-level signal from the main out, either pre- or post-main level control [32], depending on the setting of the live/record switch [12].

12. LIVE/RECORD Switch

When this switch is out (live position), the RCA main outs provide the signal just after the main level control [32], so it essentially provides the same signal as the XLR main outs [9], except it is an unbalanced signal rather than a balanced one.

When this switch is pushed in (record position), the RCA main outs provide the signal just prior to the main level control. This allows you to make a stereo recording that is not affected by main out level changes during a performance.

13. POWER Switch

When the power switch is turned on, power is supplied to the d.2 Pro and the cool blue EQ knobs light up.

14. Power Receptacle

This is a standard 3-prong IEC power connector. Connect the detachable linecord (included in the box with your d.2 Pro) to the power receptacle, and plug the other end of the linecord into an AC outlet.

The d.2 Pro has a universal power supply that can accept any AC voltage from 100 VAC to 240 VAC. No need for voltage select switches. It will work virtually anywhere in the world. It is less susceptible to voltage sags or spikes than conventional power supplies, providing greater electromagnetic isolation and better protection against AC line noise.

15. FIREWIRE Connections



FireWire (a.k.a. IEEE 1394) is a high-speed serial I/O interface for connecting digital devices. The d.2 Pro has two FireWire connectors for transferring digital audio to and from the digital audio workstation running on your laptop computer. Use either connector.

The FireWire interface provides a total of 13 audio outputs to your computer, including:

- Main mix outputs L/R (2 outputs)
- FX sends L/R (2 outs)
- Post-EQ microphone (1 out)
- Post-EQ program channel L/R (4 outs)
- Line/phono direct program L/R (4 outs)

The main output signals are pre-main level control [32], so they are independent of any adjustments made to the main level control. This allows you to easily record your live performance directly to your laptop.

The FireWire interface also lets you use your computer to playback six channels into the d.2 Pro:

- Program 1 L/R (2 inputs)
- Program 2 L/R (2 inputs)
- FX Returns L/R (2 inputs)

The FireWire program source for pgm 1 and pgm 2 is selected using the source select switch [26]. Two other FireWire channels can be returned to the main mix by pressing the FireWire FX return switch [37].

See Appendix E on page 26 for more FireWire details. The block diagram on page 23 shows the points where FireWire signals enter and leave the mixer.

Top Panel Features

MIC Input Section

16. MIC LEVEL

This knob adjusts the gain of the mic preamp for any microphone plugged into the mic input jack [1]. It ranges from +3 dB to +50 dB, with a fixed gain of +10 dB, giving an effective gain range of +13 dB to +60 dB. Adjust this so that the loudest speaking or shouting that you do into the microphone just barely lights the OL LED [18]. This gives you the best signal-to-noise ratio for the mic preamp.

17. MIC SIGNAL LED

This green LED is a signal present indicator. It lights when the microphone signal reaches -20 dBu, to give you a clue that the microphone is working.

18. MIC OL LED

This LED lights when the microphone signal reaches 6 dB below clipping. It's okay if this LED blinks occasionally, but if it is blinking frequently or lit continuously, turn down the mic level control [16] until it just blinks occasionally.

19. 48V Phantom Power Switch

If your microphone is a condenser design, it probably requires phantom power to operate. Push in this switch to supply 48 VDC to pins 2 and 3 of the XLR microphone connector.

Dynamic microphones, like Shure's SM57 and SM58, do not require phantom power. However, phantom power will not harm most dynamic microphones should you accidentally plug one in while the phantom power is turned on. Check your microphone's user's manual if you are not sure whether your microphone needs phantom power or not.

20. HIGH EQ

This knob gives your mic signal up to 15 dB of boost and cut at 12 kHz and above. At the center position the high EQ has no effect on the signal.

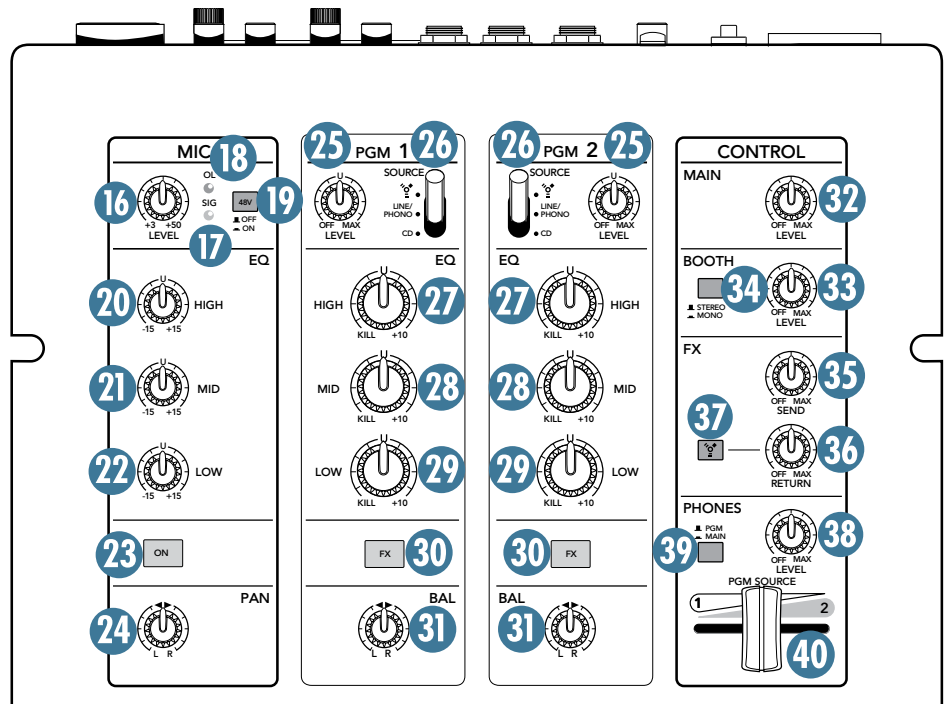

21. MID EQ

This knob gives you up to 15 dB of boost and cut at 2.5 kHz. At the center position the mid EQ has no effect on the signal.

22. LOW EQ

This knob gives you up to 15 dB of boost and cut at 80 Hz and below. At the center position the low EQ has no effect on the signal.

23. ON

Press this switch in to send the microphone signal to the main outputs, otherwise, your dulcet tones will not be heard, and people will say "huh?"

24. PAN

This knob adjusts the amount of microphone signal that is sent to the left versus the right main outputs. When the knob is turned hard left, the signal feeds only the left main out, and when the knob is turned hard right, it only feeds the right main out. When the knob is in the center, the microphone signal is sent equally to the left and right main mix. The fiendish design of the pan circuit allows "constant pan power," where the average audio output level remains constant for all positions of the pan control.

Program Input Section

25. LEVEL

This knob adjusts the gain of the program input signals selected by the position of the source select switch [26]. This knob ranges from off to +13 dB of gain at maximum. Adjust this with your good eye on the program meters [43], so the level is typically bouncing between the 0 and +6 LEDs.

26. SOURCE Select

This switch selects one of three possible input sources for the program channel:

FireWire: The signal coming in from the FireWire interface is selected as the source.

Line/phono: The signal connected to the phono input [3] is selected. This could be from a turntable or from a line-level playback device, depending on the setting of the line/phono switch [4].

CD: The signal connected to the CD input [2] is selected.

Using this heavy duty switch, you can have signals coming in on all three inputs, and quickly change from one input source to another, without the need for repatching.

27. HIGH EQ

This knob gives you up to 10 dB of boost at 4 kHz and above, and turns off the signal at 4 kHz and above when the knob is turned to the kill position. At the center position, the high EQ has no effect on the signal.

28. MID EQ

This knob gives you up to 10 dB of boost at 1 kHz, and turns off the signal at 1 kHz when the knob is turned to the kill position. At the center position, the mid EQ has no effect on the signal.

29. LOW EQ

This knob gives you up to 10 dB of boost at 300 Hz and below, and turns off the signal at 300 Hz and below when the knob is turned to the kill position. At the center position, the low EQ has no effect on the signal.

When all three EQ knobs are turned to the kill position, the signal is effectively muted and no signal passes through to the output.

30. FX

Press this switch in to send the program signal to the FX send outputs [6]. This allows you to send the signal to an external effects processor, or even provide a direct feed for the program signal to another mixer. This switch will route the program signal to the FX send output connectors, interrupting the signal to the main outputs. If there is no effects processor connected to the FX send and returns, then the program signal is muted.

31. BAL

This knob works like the balance control on a home stereo. Turning the knob to the left turns down the right side, and turning the knob to the right turns down the left side. When the control is in the center, the left and right sides are equally as loud (assuming the left and right inputs are equal loudness).

Control Section

32. MAIN LEVEL

This knob adjusts the main output level at the main out XLRs [9] (and to the RCA main outs [11] when the live/record switch [12] is out). (Remember, when the live record switch is pushed in, the RCA main outs are not affected by the main level control.)

33. BOOTH LEVEL

This knob adjusts the output level at the booth outputs [8].

34. STEREO/MONO

With this switch up, the booth outputs [8] provide a stereo left and right output of the main mix. Push the switch in to combine the left and right signals to mono if you only have one booth monitor speaker.

35. FX SEND LEVEL

This knob controls the amount of signal being sent to FX send outputs [6]. Adjust this knob to provide an appropriate input signal level to your external effects processor (or whatever you have connected to the FX sends). It ranges from off to +13 dB at maximum.

Note: The FX sends are affected by the transform switches [41], so if you mute a pgm channel with the transform switch, the FX send for that pgm channel is muted as well.

36. FX RETURN LEVEL

This adjusts the signal level coming from your external effects processor via the FX return jacks [7]. Use it to adjust the processed signal going to the main mix bus. It ranges from off to +13 dB at maximum.

37. FIREWIRE FX RETURN

Press this in if the FX return comes from your computer via FireWire. For example, a processed (wet) audio signal to add to the main mix.

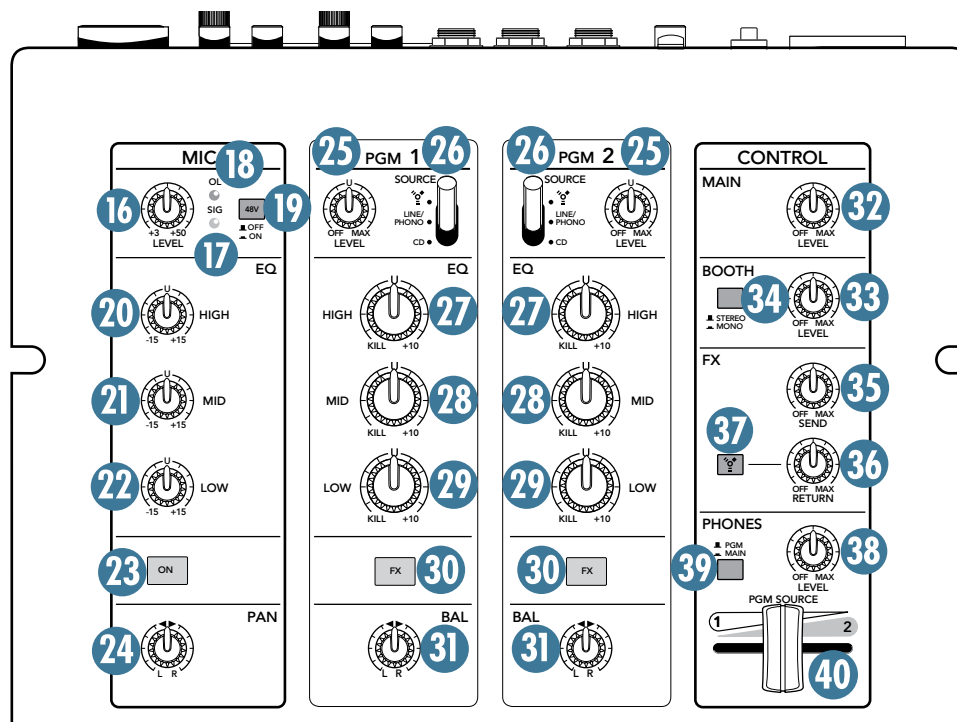

Leave it pressed out if the wet return signals come into the FX return jacks [7] from an external processor.

38. PHONES LEVEL

This controls the volume of the phones output from off to maximum gain.



Turn it to off before connecting and putting on headphones. Increase it slowly to a safe listening level. See headphone jack [50] on page 17.

39. PGM/MAIN

Use this switch to select the source for the headphones signal. When the switch is up (pgm position), the signal is tapped just after the bal control [31] on the pgm channels. You can use the pgm source crossfader [40] to fade between pgm 1 and pgm 2.

When the switch is down (main position), the signal is tapped from the main mix bus, just before the main level control [32].

40. PGM SOURCE

When the pgm/main switch [39] is up (in the pgm position), you can use this crossfader to listen to pgm 1 and pgm 2 in the headphones. When the crossfader is all the way to the left, pgm 1 is heard in the headphones. When the crossfader is all the way to the right, pgm 2 is heard in the headphones. When the knob is in the center, the headphones get an even mix of pgm 1 and 2.

Note: When the pgm/main switch is down (main position), this control has no effect on the phones output.

Program Output Section

41. TRANSFORM

The transform switch has three positions: latching, center, and momentary.

When the switch is latched, this program's signal is on, and passes through to the outputs.

When the switch is in the center position, this program's signal is muted at the outputs and FX sends.

The other position is a momentary version of the latched position (in other words, it won't stay there when you let go of it), and allows the signal to pass as long as the switch is held down. Let go of the switch, and the signal is muted again. This lets you quickly use the transform switch for "stutter" effects.

If you prefer, you can rotate the transform switch 45° or 90° so the switch moves diagonally or horizontally instead of vertically. See Appendix D on page 24 for more information.

Note: If this switch is in the center position, the program can still be heard and cued in the headphones if the pgm/main switch [39] is up.

42. PROGRAM FADER

This controls the volume for the pgm signal being sent to the main mix bus. The characteristics of how the fader affects the audio signal are determined by the corresponding front panel contour control [48] and reverse switch [49].



These faders have a very light touch and are designed to last the lifetime of the d.2 Pro. No audio passes through these faders. Rather, they send a control voltage to a pair of VCAs (voltage-controlled amplifiers) that determine the gain of the signal. This is a very good thing, by the way, as the audio will not be affected by any scratchy electrical contacts, and the design allows for customizing the fader action using the contour and reverse controls.

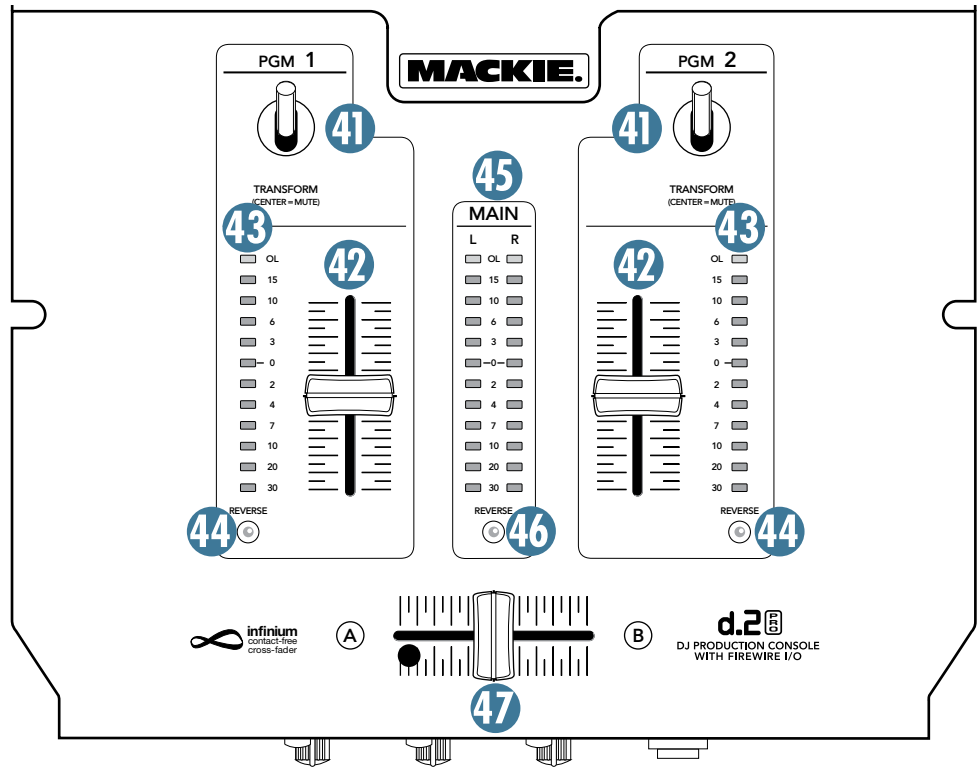

43. PGM LEVEL METERS

These meters have 12 LEDs, ranging from -30 to +20 (OL). They indicate the summed-mono signal strength of the pgm signals just before the bal controls [31]. The meters are not affected by the program faders [42].

Typically, you want to see these meters bouncing between the "0" and the "+6" LEDs. It is okay if the OL LED lights occasionally, but if it lights frequently or continuously, turn down the pgm level control [25] until the OL LED blinks occasionally or not at all.

44. REVERSE LED

These light when the front-panel reverse switches [49] have been activated for pgm 1 or pgm 2 faders. They show that the fader direction-of-action is reversed. (The meters are not reversed, just the faders.)

45. MAIN LEVEL METERS

These meters are similar to the pgm level meters [43], but indicate the signal strength of the main outputs before the main level control. As with the other meters, you want to see the signals bouncing between the "0" and the "+6" LEDs. It is okay if the OL LEDs light occasionally, but if they light frequently or continuously, turn down the program faders [42] until the OL LEDs blink occasionally, or not at all.

46. REVERSE LED

This LED lights when the reverse switch [49] has been activated for the crossfader. For more details, see the discussion of the reverse switches on the next page.

47. CROSSFADER

The crossfader is used to fade between the two pgm signals in the main outputs. When the crossfader is all the way to the left, pgm 1 is heard in the main outs. When the crossfader is all the way to the right, pgm 2 is heard. When the crossfader knob is in the center, the main outs get an even mix of pgm 1 and 2.

The characteristics of how the crossfader affects the audio signal are determined by its corresponding contour control [48] and the reverse switch [49].



The crossfader is a high-quality infinium contact-free optical digital fader, designed to last the lifetime of the d.2 Pro with no degradation in quality.

You can adjust the tension of the fader movement to your specific taste, by following these steps:

1. Turn off the AC power, and remove the power cord from the mixer.
2. Move the crossfader all the way to the left.
3. Remove the fader cap (knob) by grasping it firmly and pulling straight up.
4. Use a small slot-head screwdriver to turn the screw located through the hole on the left side of the crossfader slot.

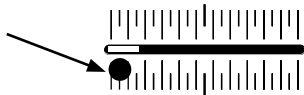

Rotate the screw clockwise to tighten the tension, and rotate the screw counter-clockwise to loosen the tension. You might need a flashlight to make sure you are lined up on the screw.

5. Replace the fader cap, and you're all done.

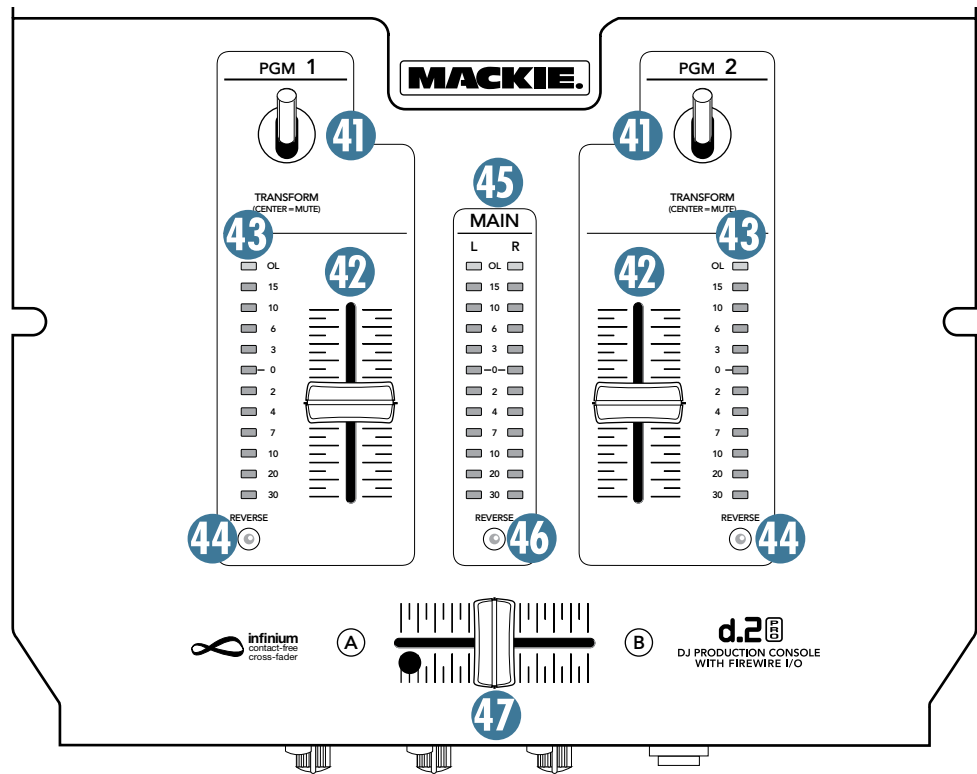

Front Panel Features

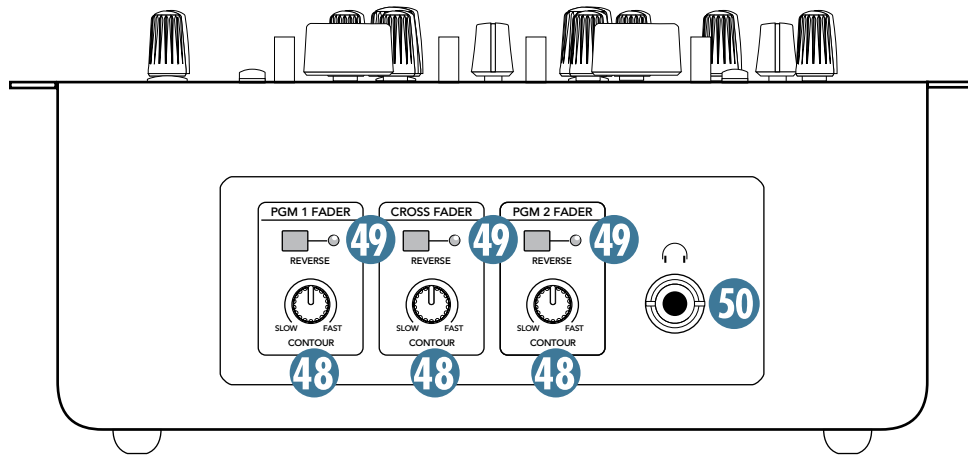

48. CONTOUR

Use the contour controls to adjust how fast or slow each fader responds to movement. In the slow position, the faders respond in a linear fashion, increasing from minimum to maximum at the same rate. In the fast position, the faders respond logarithmically, increasing from minimum to maximum very quickly, and then changing very little for the remainder of the fader travel. Adjust the contour controls between the two extremes to get the fader response that works best for your application.

The contour control for the crossfader works in a similar fashion, crossfading linearly with the contour control in the slow position, and crossfading very quickly with the contour control in the fast position. In fact, in the fast position, the crossfading occurs within the first 2 mm of fader travel. This is great for “crabbing” techniques.

49. REVERSE

Normally (with these switches out) when you move the pgm 1 or pgm 2 faders up, the volume will increase. When you move the crossfader left to right, pgm 1 will fade into pgm 2.

These switches let you reverse the direction of the action of the program faders and the crossfader:

With the pgm 1 or pgm 2 reverse switches on, when you move the pgm 1 or pgm 2 faders up, the volume will now decrease.

With the crossfader reverse switch on, when you move the crossfader left to right, pgm 2 will fade into pgm 1. (This is sometimes called a hamster switch.)

Note: These switches and the contour controls do not affect the meters, just the faders.

50. Headphones Jack

This is where you plug in your stereo headphones. It is a 1/4" TRS stereo jack.

If you have the pgm/main switch [39] up, you can listen to the pgm 1 or pgm 2 signals, or a mix of both, determined by setting the pgm source slider [40]. The signals are taken just after the bal controls [31], but before the program faders [42].

If you have the pgm/main switch [39] down, you can listen to the main mix signals, taken just before the main level control [32].

The headphone volume is controlled by the phones level control [38], and the position of the pgm source crossfader [40] if you are listening to pgm 1 or pgm 2.



Warning: The headphone amp is designed to drive any standard headphones to a very loud level. We're not kidding! It can cause permanent hearing damage. Even intermediate levels may be painfully loud with some headphones. Be careful!



Always start with the phones level control [38] turned all the way down before connecting headphones to the phones jack, or making any connections. Keep it down until you've put on the headphones. Set the pgm source slider [40] if you are listening to pgm 1 or pgm 2, then turn up the phones level control slowly. Why? Always remember: “Engineers who fry their ears, find themselves with short careers.”

Appendix A: Service Information

Warranty Service

Details concerning Warranty Service are spelled out in the Warranty section on page 31.

If you think your d.2 Pro has a problem, please do everything you can to confirm it before calling for service. Doing so might save you from the deprivation of your mixer and the associated suffering.

These may sound obvious to you, but here are some things you can check. Read on:

Troubleshooting

No Power

- Make sure the power cord is securely seated in the IEC socket [14] and plugged all the way into the AC outlet.
- Make sure the AC outlet is live (check with a tester or lamp).
- Make sure the rear panel power switch [13] is in the on position (up).
- Are the EQ controls on the front panel illuminated? If not, make sure the AC outlet is live.
- Are all the lights out in your town? If so, contact your local power company to get power restored.
- If no LEDs are illuminated, and you are certain that the AC outlet is live, it will be necessary to have your d.2 Pro serviced. *There are no user serviceable parts inside.* Refer to “Repair” on the next page to find out how to proceed.

Bad Channel

- Check the transform switch [41] is not in the center position.
- Is a fader or crossfader reverse LED [46] on?
- Check the channel’s program fader [42] is not fully down.
- Are that channel’s EQ controls all turned down?
- Is the signal source turned up? Make sure the signal level from the selected input source is high enough to light up some of the program meter LEDs [43].
- Is the correct input chosen with the source select switch [26], and its pgm level [25] turned up enough?

- If the FX button [30] is pressed on that channel, make sure your effects processor is connected correctly and is working.
- Try the same source signal in the other channel, set up exactly like the suspect channel.

Bad Output

- Is the associated level control (if any) turned up?
- If it’s one of the main outputs, try unplugging the others. For example, if it’s the XLR left main out, unplug the RCA left out. If the problem goes away, it’s not the mixer.
- If a left output is presumed dead, switch the left and right cords at the mixer end. If the problem stays on the left side, it’s not the mixer.

Bad Sound

- Is the input connector plugged completely into the jack?
- Is it loud and distorted? Make sure the input level control [25] is set correctly. Reduce the signal level on the input source if possible.
- If possible, listen to the signal with headphones plugged into the input source device. If it sounds bad there, it’s not the d.2 Pro causing the problem.
- If you are using a turntable with a phono-level output, and the sound is low and distorted, check that the line/phono switch [4] is set to phono. Note that the phono section requires your cartridge to be a moving magnet type. It may be too low to amplify the low levels of a moving coil type.

Noise/Hum

- Turn down the FX return knob [36]. If the noise disappears, it’s coming from whatever is plugged into the FX returns [7].
- Check that your turntable’s audio ground wire is connected to the gnd terminals [5].
- Turn down each channel, one by one. If the noise disappears, it’s coming from whatever is plugged into that channel. Check your whatever.
- Check the signal cables between the input sources and the d.2 Pro. Disconnect them one by one. When the noise goes away, you’ll know which input source is causing the problem.

- Sometimes it helps to plug all the audio equipment into the same AC circuit so they share a common ground.

Recording to FireWire

- If you are recording vinyl music to your computer, and the level seems low, record using the FireWire outputs (5, 6, 7, 8) that come after the EQ section. This will give you the chance to boost the levels a tad with the level controls [25]. Set the source select switch [26] to line/phono, and the line/phono switch [4] to phono.
- If you are using timecode vinyl or timecode CD, then use the Firewire outputs (1, 2, 3, 4) that come directly after the phono section. In this way, you can have the timecode flowing to your computer, and use the source selector switch to play the computer output in that same program channel.

Repair

Service for Mackie products is available at a factory-authorized service center. Service for Mackie products living outside the United States can be obtained through local dealers or distributors.

If your d.2 Pro needs service, follow these instructions:

1. Review the preceding troubleshooting suggestions. Please.
2. Call Tech Support at 1-800-898-3211, 7 am to 5 pm PST, to explain the problem and request a Service Request Number. Have your d.2 Pro's serial number ready. You must have an Service Request Number before you can obtain warranty service.
3. Keep this owner's manual and the detachable linecord. We don't need them to repair the mixer.
4. Pack the mixer in its original package, including endcaps and box. This is VERY IMPORTANT. Mackie is not responsible for any damage that occurs due to non-factory packaging.
5. Include a legible note stating your name, shipping address (no P.O. boxes), daytime phone number, Service Request Number, and a detailed description of the problem, including how we can duplicate it.
6. Write the Service Request Number in BIG PRINT on top of the box. Units sent without the SR number will be refused.
7. Tech Support will tell you where to ship the d.2 Pro for repair. We suggest insurance for all forms of cartage.
8. You will need to contact the authorized service center for their latest turn-around times. The d.2 Pro must be packaged in its original packing box, and must have the Service Request Number on the box. Once it's repaired, the authorized service center will ship it back by ground shipping, pre-paid (if it was a warranty repair).

Note: Under the terms of the warranty, you must ship or drop-off the unit to an authorized service center. The return ground shipment is covered for those units deemed by us to be under warranty.

Note: You must have a sales receipt from an authorized Mackie dealer for your unit to be considered for warranty repair.

Appendix B: Connections

XLR Connectors

The d.2 Pro mic combo input accepts 3-pin male XLR connectors; the main outs accept 3-pin female XLR connectors. These are wired as follows, according to standards specified by the AES (Audio Engineering Society).

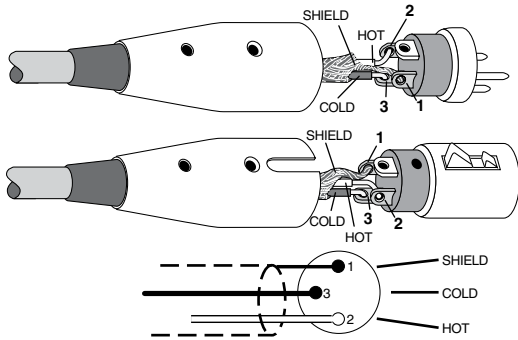

XLR Balanced Wiring:

- Pin 1 = Shield
- Pin 2 = Hot (+)
- Pin 3 = Cold (-)

1/4" TRS Phone Plugs and Jacks

“TRS” stands for Tip-Ring-Sleeve, the three connection points available on a stereo 1/4" or balanced phone jack or plug. TRS jacks and plugs are used for balanced signals and stereo headphones:

Balanced Mono

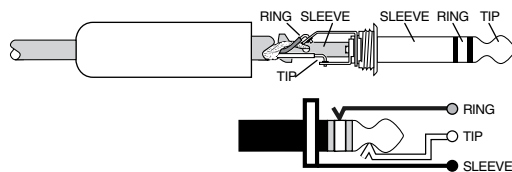

1/4" TRS Balanced Mono Wiring:

- Sleeve = Shield
- Tip = Hot (+)
- Ring = Cold (-)

Stereo Headphones

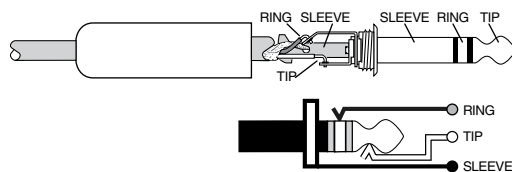

1/4" TRS Stereo Unbalanced Wiring:

- Sleeve = Shield
- Tip = Left
- Ring = Right

1/4" TS Phone Plugs and Jacks

“TS” stands for Tip-Sleeve, the two connection points available on a mono 1/4" phone jack or plug. They are used for unbalanced signals.

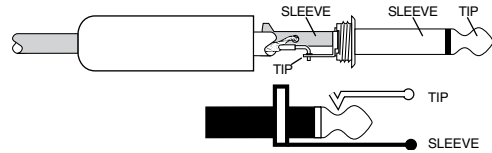

1/4" TS Unbalanced Wiring:

- Sleeve = Shield
- Tip = Hot (+)

RCA Plugs and Jacks

RCA-type plugs (also known as phono plugs) and jacks are often used in home stereo and video equipment and in many other applications. They are unbalanced and electrically equivalent to a 1/4" TS phone plug.

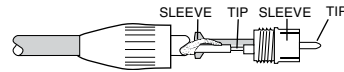

RCA Unbalanced Wiring:

- Sleeve = Shield
- Tip = Hot (+)

Appendix C: Technical Info

Specifications

Frequency Response (20 Hz to 20 kHz) :

Mic input to any output:	+0/-0.5 dB
Line/CD input to any output:	+0/-0.5 dB
Phono input to any output:	±0.5 dB RIAA EQ curve
FireWire output channel 1 or 2 to the FireWire input of the opposite channel:	+0/-1 dB

Distortion (THD+N):

Main output, 20 Hz to 20 kHz	
Mic Input, -20 dBu in, +30 dB gain, +10 dBu out:	Better than 0.007%
Line/CD input at unity gain:	Better than 0.015%
Phono input, -30 dBu in, 0 dBu out:	Better than 0.020%
FireWire direct out, looped back to same channel's FireWire input, unity gain:	Better than 0.025%
Phones output, 20 Hz to 20 kHz, +4 dBu input signal	
Line input @ 0 dB Gain:	Better than 0.015%

Common Mode Rejection Ratio (CMRR):

Mic input, maximum gain, 1 kHz:	Better than 60 dB
---------------------------------	-------------------

Crosstalk (1 kHz, 20 Hz to 20 kHz):

Signal placed on any channel, transform switch disengaged, opposite channel measured at main outs, channels at unity gain:
Better than -70 dBu

Signal placed on any channel, out and in over FireWire, transform switch disengaged, opposite channel measured at main outs, channels at unity gain:
Better than -80 dBu

Noise Characteristics:

Equivalent Input Noise (E.I.N.), 20 Hz to 20 kHz, max gain:	
Mic input, 150 Ω source:	Better than -125 dBu
Phono input, 500 Ω/500 mH source:	Better than 0.3 μV

Signal to Noise Ratio:

Main out at unity, 20 Hz to 20 kHz, ref +4 dBu, all channel gain knobs at minimum:	Better than -92 dB
Main out at unity, 20 Hz to 20 kHz, ref +4 dBu, all channel gain knobs at unity:	Better than -88 dB
Main out at unity, 20 Hz to 20 kHz, ref +4 dBu, FireWire inputs selected at both channels and at unity:	Better than -82 dB

Maximum Input Levels (rated at 1% THD):

Mic input, preamp gain at minimum:	+9.5 dBu
Line/CD inputs, preamp gain 0 dB:	+22.5 dBu
Aux input:	+22.5 dBu
Phono input:	185 mV @ 1kHz

Input/Output Characteristics:

Input gain control range:	
Mic input:	+3 dB to +50 dB, (+10 dB fixed gain, effective range: +13 dB to +60 dB)
PGM input:	Off to +13 dB
Aux return:	Off to +13 dB
Output gain control range:	
Main output:	Off to +12 dB
Aux output:	Off to +12 dB
Booth output:	Off to 0 dB

Input Impedance:

Mic input:	2.4 kΩ balanced
Line/CD input:	20 kΩ balanced
FX return:	20 kΩ balanced
Phono input:	47.5 kΩ shunted with 200 pF

Maximum Output Levels:

XLR main output:	+22.5 dBu
RCA main output:	+22.5 dBu
Booth output:	+22.5 dBu
Aux send:	+22.5 dBu
Phones:	2.94 Vrms into 32Ω (270 mW)

Output Impedance:

Main XLR/RCA output:	150 Ω
Booth output:	150 Ω
Aux send:	150 Ω
Phones:	25 Ω

Equalization

Mic channel	
Low:	±15 dB @ 80 Hz
Mid:	±15 dB @ 2.5 kHz
High:	±15 dB @ 12 kHz
PGM channel	
Low:	+10/-inf dB @ 300 Hz
Mid:	+10/-inf dB @ 1 kHz
High:	+10/-inf dB @ 4 kHz

FireWire:

Sample rates available:	44.1 kHz, 48 kHz, 88.2 kHz, and 96 kHz
Buffer Size:	Adjustable from 2 ms to 20 mS in steps of 1 ms
Resolution:	24-bit

VU Meters

12-segment pre-fader PGM meters	
12-segment pre-fader main mix meters	
OL (+20), +15, +10, +6, +3, 0, -2, -4, -7, -10, -20, -30	
Mic input signal present LED (sensitivity):	-20 dBu
Mic input overload LED:	+18 dBu

AC Power Requirements:

Power consumption:	25 watts
Universal AC Power Supply:	100 VAC - 240 VAC, 50-60 Hz

continued

Physical Dimensions and Weight:

Height: 15.49 in/393 mm (including knobs and connectors)

Width: 10.00 in/254 mm

Depth: 4.62 in/117 mm (including knobs and connectors)

Weight: 11.5 lb/5.2 kg

The d.2 Pro mounting slots are compatible with the Odyssey Battle Bridge. This consists of two L brackets which bolt to the d.2 Pro and allow you to fit it securely between two turntable cases. See www.odysseygear.com for more details.

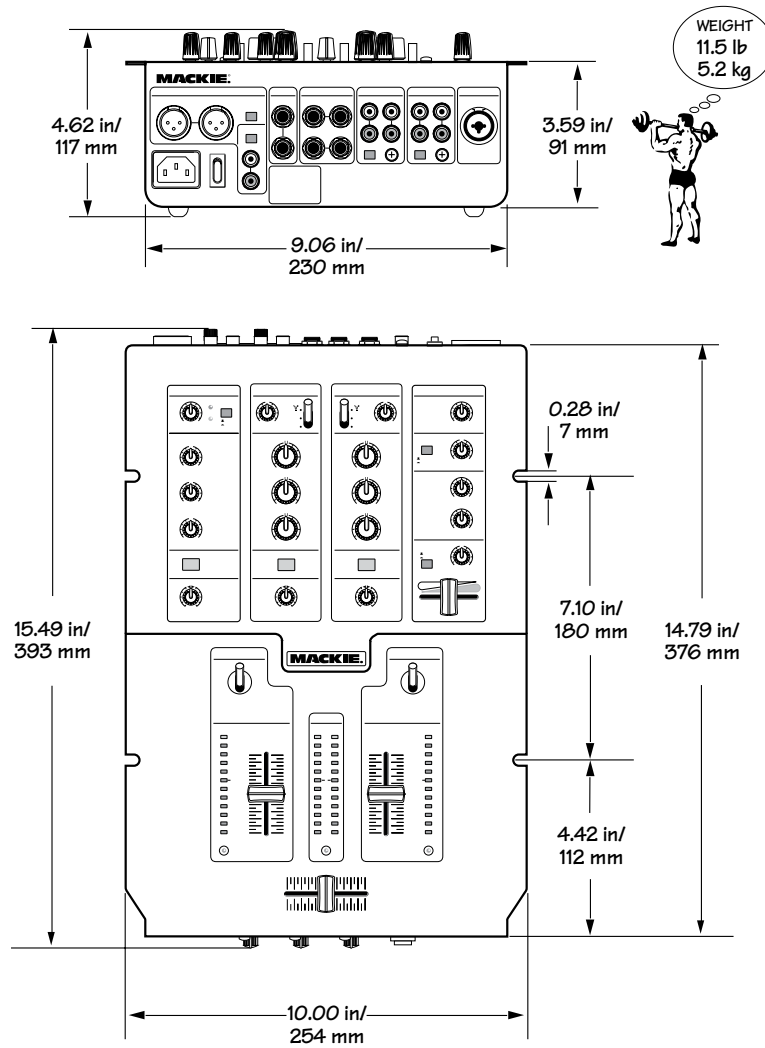

LOUD Technologies Inc. is always striving to improve our products by incorporating new and improved materials, components, and manufacturing methods. Therefore, we reserve the right to change these specifications at any time without notice.

“Mackie,” and the “Running Man” are registered trademarks of LOUD Technologies Inc. All other brand names mentioned are trademarks or registered trademarks of their respective holders, and are hereby acknowledged.

We cannot comment on the d.2 Pro’s ability or inability to open a pathway to M31, the Great Andromeda Galaxy. All reports that our entire engineering team disappeared for three weeks, and came back with weird suntans, and a Llama-like animal called Pierre that writes owner’s manuals, are probably highly exaggerated.

©2007 LOUD Technologies Inc. All Rights Reserved.

Block Diagram

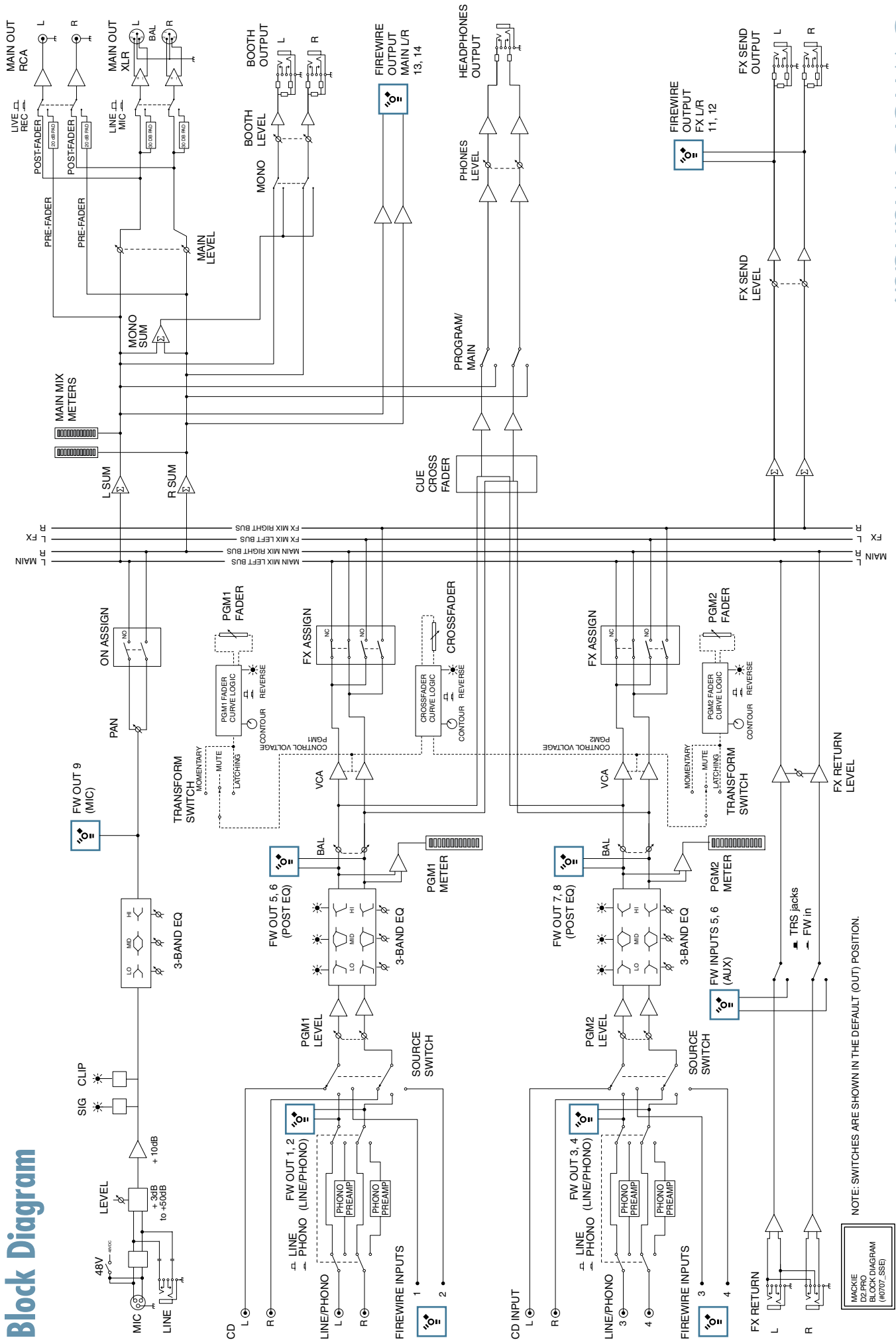

NOTE: SWITCHES ARE SHOWN IN THE DEFAULT (OUT) POSITION.

MACKIE
D2 PRO
BLOCK DIAGRAM
(#0707_SSE)

Appendix D: Transform Switch Rotation and Fader Replacement

Transform Switch Rotation

From the factory, the transform switches operate vertically, that is (to get all technical for a moment) fore and aft.

You can perform a simple modification to make these switches operate sideways, or even diagonally, to suit your carefully cultivated set of operational preferences.

Tools

To do this procedure, you will need a small phillips screwdriver, nerves of steel, grit, determination, and a steady hand. People should find you ruggedly charming, yet approachable.

Procedure

1. Remove the power cord, and any other cords or cables connected to the d.2 Pro.
2. Gently place the d.2 Pro face upwards on a flat, clean and dry surface, such as the kitchen table.
3. Remove the three slider knobs, by gently pulling them upwards. Keep them safe.
4. Undo the five screws from the top panel and two screws from the front, as shown. Keep the screws in a safe place.

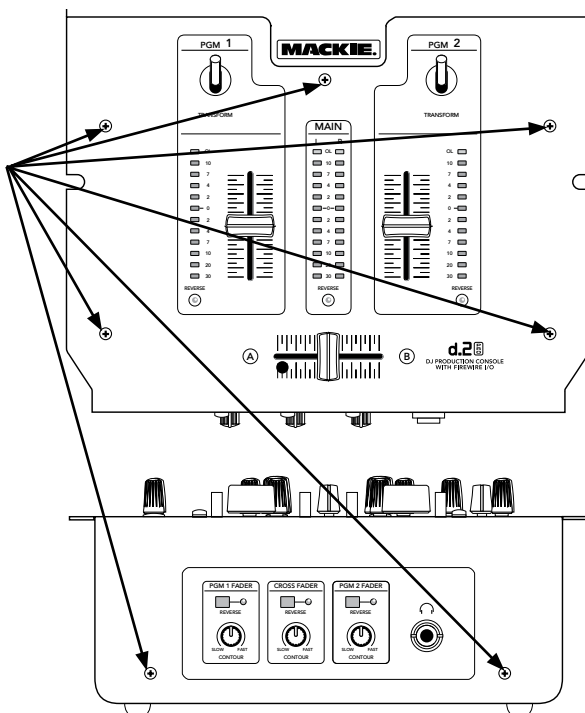

5. Gently lift off the panel, taking care not to damage the front panel contour knobs. Keep it in a safe place where it won't get scratched, or fall off the table.

6. Each transform switch has four screws, but remove only the outer two. These are black, whereas the inner screws are bright and shiny.

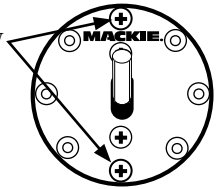

7. Rotate the switch assembly to suit your preference, and replace the two screws.

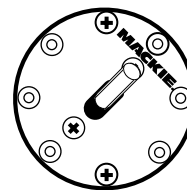

Diagonally

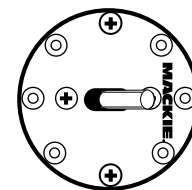

Sideways

8. If you need to replace a transform switch, gently pull it out just enough so you can reach and undo its connector. Connect the new switch securely, and screw it in the desired position. You might want to replace both switches, if they are both aged and/or had a rough life.

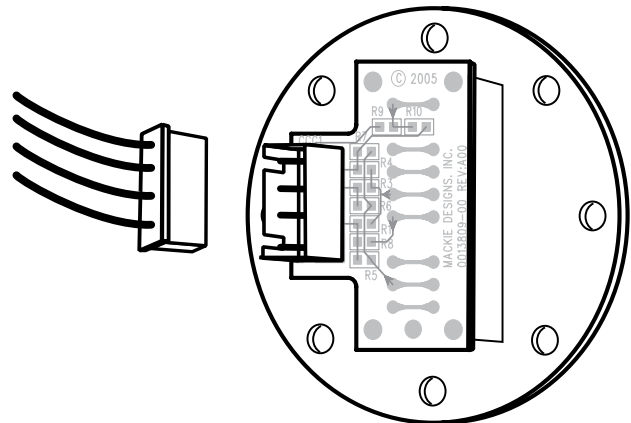

9. Replace the top cover, and make sure that all the meter LEDs and the Reverse LEDs are poking through before you tighten down the screws securely.

Replacing Faders

If the faders ever need to be replaced, this can be done with the help of your trusty screwdriver.

10. Follow steps 1 to 5 and remove the top panel.
11. Take care to only remove the two outer screws of each fader you are replacing, as shown below.

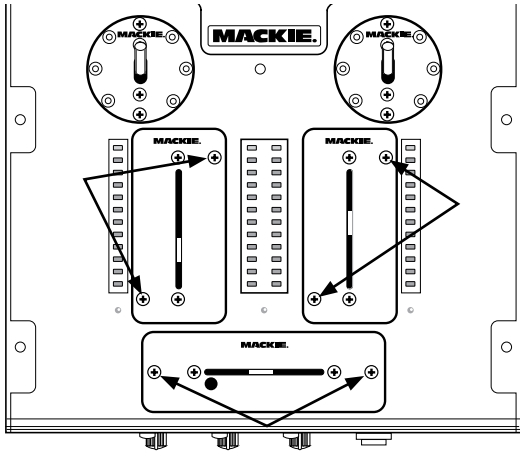

14. Secure the fader assembly to the chassis with the two screws you lost in step 11.
15. Replace the top cover, and make sure that all the meter LEDs and the Reverse LEDs are poking through before you tighten down the screws securely.
16. Check that all the faders and switches are working normally. (You might have to reset the tension if you changed the crossfader.)

12. Gently lift up the fader assembly, just enough to be able to pull the connector out of the receptacle on the bottom of the fader assembly.

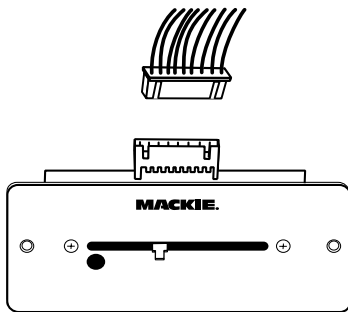

Removing the Crossfader Connector

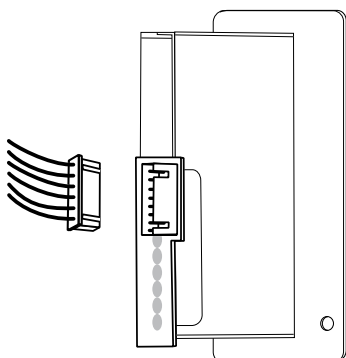

Removing a Program Fader Connector

13. Insert the connector into the receptacle on the new fader assembly. (It will only fit in one way.)

Appendix E: FireWire

System Requirements

These are the minimum requirements for your computer system to use the d.2 Pro FireWire interface.

For the PC:

- Windows XP (service pack 2)
- Pentium 4 or Athlon XP processor
- 256 MB RAM

For the Mac:

- OS X (10.3.9 or higher)
- G4 processor
- 256 MB RAM

The internal FireWire interface will:

- Allow multiple streams of digital audio to be sent bi-directionally between the d.2 Pro and a Mac or PC computer.
- With all of the streaming choices available, it is possible to make a true multitrack recording of ALL the different inputs coming into the mixer's channels, as well as any audio coming into the mic input, and keep all of it separate for a later mixdown. In addition, with the FX and main outputs also going to their own tracks, you can have a complete main or alternate mix go to the computer, ready for CD burning or conversion to MP3s.

FireWire stream to computer

The following table shows the outputs to your computer from the d.2 Pro FireWire interface:

To	From
Computer input 1	PGM 1 LINE/PHONO L
Computer input 2	PGM 1 LINE/PHONO R
Computer input 3	PGM 2 LINE/PHONO L
Computer input 4	PGM 2 LINE/PHONO R
Computer input 5	PGM 1 POST EQ L
Computer input 6	PGM 1 POST EQ R
Computer input 7	PGM 2 POST EQ L
Computer input 8	PGM 2 POST EQ R
Computer input 9	MIC
Computer input 10	NULL
Computer input 11	FX Send L
Computer input 12	FX Send R
Computer input 13	MAIN Out L
Computer input 14	MAIN Out R

Each channel of analog audio from the d.2 Pro is converted to digital signals by the FireWire interface's splendid A/D converters. (The block diagram on page 23 shows the location of the FireWire inputs and outputs.)

Program channel outputs

For the program channels, there are two points where the FireWire is tapped off:

- Computer inputs 1 to 4 receive the audio program channel Line/Phono inputs pre-EQ, and pre-fader, independent of the position of the program source switch [26].
- Computer inputs 5 to 8 receive the audio program channels post-EQ, and pre-fader. The source switch [26] affects what is playing in the program channel and the FireWire output.

If you are partial to block diagrams, Figure 1 opposite shows a partial block diagram of the signal flow in a program channel. With the line/phono switch [4] set to phono, the RIAA phono preamplifier stage re-equalizes and boosts the phono-level signals to line-level, and the routing takes it directly out via FireWire to your computer.

You can use the source switch [26] to play from FireWire or a CD into the same program channel without upsetting the phono FireWire output. This means that you can play the turntable direct to your computer, and still have a different source or FireWire output

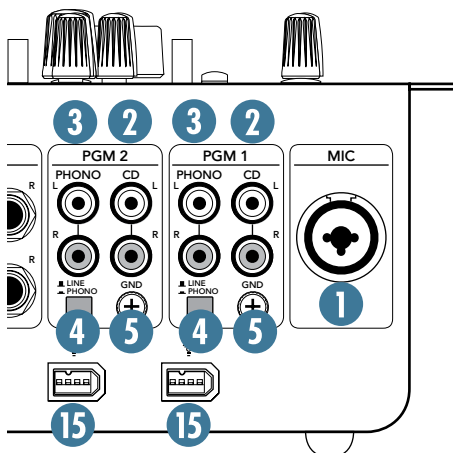

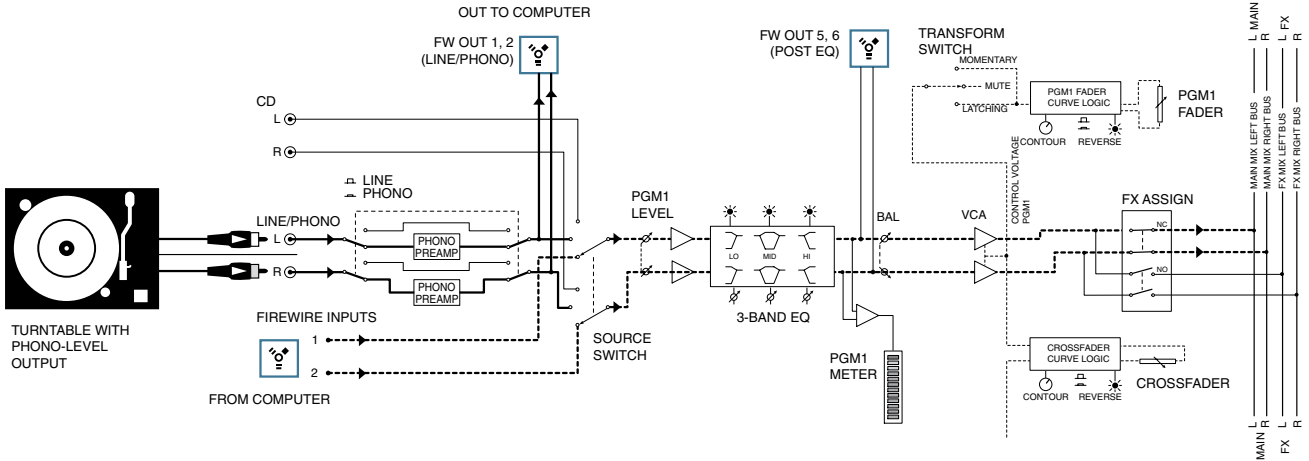

Figure 1: Direct FireWire output to your computer from a turntable

play through the same channel. This would be the way to play a timecode record for example. While on the subject, I feel a paragraph or two coming on...

Timecode Vinyl/CD

Timecode vinyl is a conventional vinyl record that plays timecode information, as do timecode CDs.

As mentioned above, the phono output from your turntable is converted to line-level by the phono stage, is converted to a digital stream by the FireWire interface and sent to your computer.

If you are playing a timecode CD on a CD deck, then connect it to the line/phono inputs [3] and set the line/phono switch [4] to line. (If it was connected to the CD inputs [2], then the computer will not receive the direct signals, but only those after the source selector, level and EQ.)

You do not want the timecode audio to actually play in your system. In figure 1 (top left), out it goes to the computer without a care in the world. With the source selector set to FireWire, you can now bring in the affected audio from your virtual turntable, and play it through the same program channel and onto the main mix bus (see dotted lines in figure 1).

Some of the DJ software companies producing timecode software, include Traktor, PCDJ and MixVibes.

Timecode tracks are carefully laid down by talented timecode musicians. They like nothing better than to get together for impromptu all-night timecode jam sessions, and tell stories of the good old days before 33 1/3.

Much-respected in this field are "The Woodinville Mountain Timecode Boys."

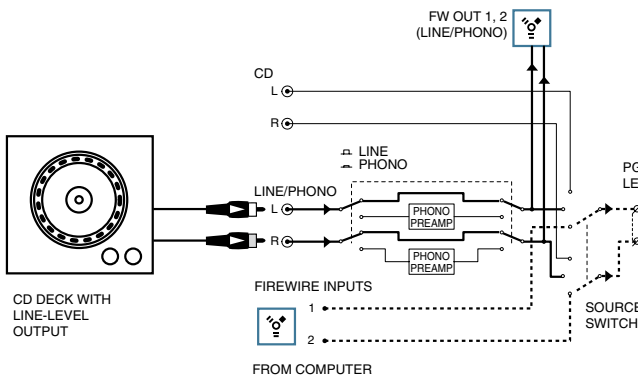

Figure 2: Direct FireWire output from CD deck

Software provided by your timecode people takes the digital stream and creates a virtual turntable on your desktop. You can add any audio track to the virtual turntable, and affect its output by scratching your physical turntable or CD deck to your heart's content. The timing of your audio track is replaced by the timecode of your turntable. If the physical turntable slows down or reverses, so does your audio track. Now you have control over any audio source you care to play.

FireWire stream from computer

The following table shows the outputs from your computer to the d.2 Pro's FireWire interface:

From	To
Computer output 1	Input to PGM 1 L
Computer output 2	Input to PGM 1 R
Computer output 3	Input to PGM 2 L
Computer output 4	Input to PGM 2 R
Computer output 5	Input to FX L
Computer output 6	Input to FX R

Each 2-channel stream from the computer enters the mixer through the FireWire connector and is converted to analog. Select FireWire as a program choice using the desired channel's source switch [26] in the same way you select a line/phono level or CD player input.

You can also select FireWire as the FX return input instead of the FX return TRS jacks [7]. Press the FireWire FX Return switch [37] in the FX section (see page 14).

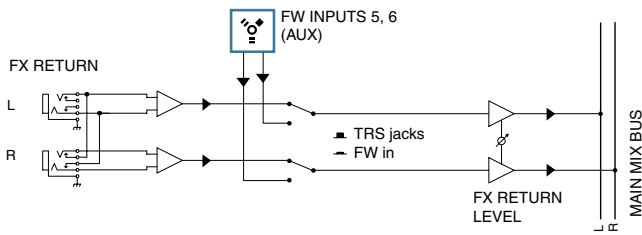

Figure 2: FireWire from computer to main mix



Beware of a possible feedback loop, if you are feeding the d.2 Pro main mix back into an input that is assigned to the main mix.

MIDI notes

The d.2 Pro will show up on a Mac or PC as a 1 input, 0 output MIDI interface named “D.Pro Mixer.” On a PC, the 0x1 MIDI interface shows up in all MIDI compatible applications. On a Mac, the 0x1 interface will show up in all compatible applications, and be visible in the Audio MIDI setup utility.

The single MIDI input will present, to any MIDI compatible application, the following MIDI message:

- A controller message, tied to the crossfader, with a value of 0 at hard left, 127 at hard right, with in-between values equally spread out across the crossfader’s travel. This allows you to use the crossfader as a performance controller with all sorts of audio software.

Action	Status	Data 1	Data 2
Crossfader position	Value: 176 Control Change Channel 1	Value: 11 Expression Controller	Value: 0 to 127 Crossfader position

Software installation

For the PC:

When using the d.2 Pro with a PC, it is necessary to first install the drivers and the control panel. The control panel allows you to set the sample rate and adjust the latency (delay) of the audio passing through the d.2 Pro FireWire interface.



Do not connect the d.2 Pro FireWire connector to your computer just yet. We’ll tell you when it’s time to do that.

To install the software on a PC running Windows XP (SP2):

1. Turn off any (non-essential) applications.
2. Insert the d.2 Pro CD-ROM into your PC’s CD-ROM drive.
3. The CD begins automatically, bringing up the d.Pro installer. If it doesn’t, click Start in the task bar, then click Run and click Browse. Browse to your CD drive and double-click d.Pro_SETUP.EXE. Then click OK to start the installation.
4. The d.Pro Installer opens. Click “Continue.”



5. Next you will see the License Agreement. Read through the text and if you are all in favor, click “I Agree.”



- The next window reminds you to make sure the d.2 Pro is NOT connected to your computer yet. Read the instructions and click "Continue."



- You may get a warning about running the installer because it hasn't passed Windows Logo testing. It's okay. We've tested it and it is compatible with Windows XP. Click "Continue Anyway."

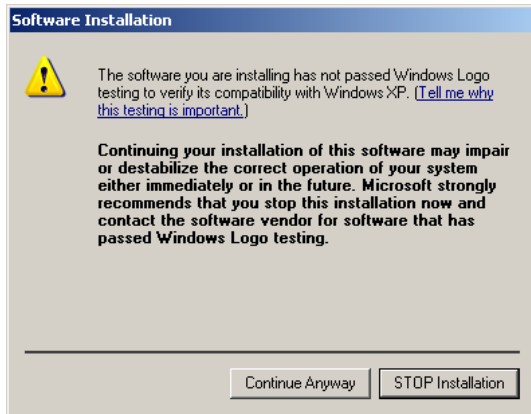

- Now it is time to connect your d.2 Pro FireWire connection to your computer. Follow the instructions and then click "Next."



- Wait until the "Found New Hardware Wizard" pops up. Do not select any options, just click "Cancel" to continue. If the same screen comes back up, click "Cancel" again.



- You will get another impertinent warning, this time about installing the hardware. It's okay. Click "Continue Anyway."

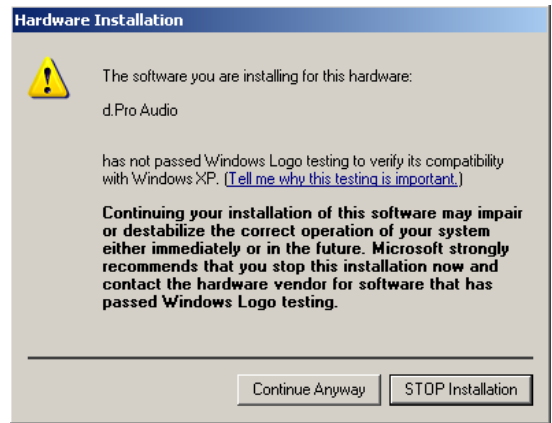

- The d.Pro drivers and control panel will be installed on your computer.
- When the installation is complete, a window will pop up to let you know that the installation was successful. Click "Finish" to er...well finish.



Now you are ready to use the FireWire capabilities of your d.2 Pro. The installer also places a shortcut to the d.Pro Console on your desktop (see next page).



Console (PC only)

You can use the console to change the sample rate and latency.

The sample rate and latency value (also known as buffer size) may also be set in your DJ performance software application's "settings" window. Make sure the same value appears in both places.



For timecode vinyl/CD work, the latency typically needs to be set between 4 ms and 15 ms.

For the Mac:

Macintosh OS X Audio MIDI Setup (version 10.3.9 or later):

Macintosh OS X does not require FireWire drivers to be installed. OS X provides a dedicated setup utility for audio and MIDI. You can use the Audio MIDI Setup utility to change the default audio input and output and general system settings on your Macintosh.

1. Go to the Applications folder and open the Utilities folder.
2. Double-click "Audio MIDI Setup."



3. Click the Audio Devices tab, and select Mackie d.Pro in the "Properties For" drop-down box.



4. Here you can see the settings for the Mackie d.Pro. You can also choose the d.Pro as your default input or output, as well as designate it to be used for system sound output.



5. You're ready to go with any Mac OS X Core Audio host application (i.e., Traktion, Logic, Cubase, Nuendo, Live, Digital Performer, etc.).

d.2 Pro Limited Warranty

Please keep your sales receipt in a safe place.

A. LOUD Technologies Inc. warrants all materials, workmanship and proper operation of this product for a period of **three years** from the original date of purchase. If any defects are found in the materials or workmanship or if the product fails to function properly during the applicable warranty period, LOUD Technologies, at its option, will repair or replace the product. **This warranty applies only to equipment sold and delivered within the U.S. by LOUD Technologies Inc. or its authorized dealers.**

B. Failure to register online or return the product registration card will not void the three-year warranty.

C. Service and repairs of Mackie products are to be performed **only** at a factory-authorized facility (see D below). Unauthorized service, repairs, or modification will void this warranty. To obtain repairs under warranty, you must have a copy of your sales receipt from the authorized Mackie dealer where you purchased the product. It is necessary to establish the purchase date and determine whether your Mackie product is within the warranty period.

D. To obtain service:

1. Call Mackie Technical Support at 800/898-3211, 7 AM to 5 PM Monday through Friday (Pacific Time) to get authorization for repair or replacement. Alternately, go to the Mackie website, click "Support" (www.mackie.com/support), and follow the instructions for reporting a warranty issue and submitting a request for an advance replacement.

2. Advance Replacement: Mackie will ship a replacement unit to you along with an invoice for the suggested retail price of the replacement unit. You must return the defective unit immediately to cancel the invoice. If you do not return the defective unit within 30 days, you must pay the full amount stated in the invoice to satisfy your debt.

3. Repair: Pack the product in its original shipping carton. Also include a note explaining exactly how to duplicate the problem, a copy of the sales receipt with price and date showing, and your return street address (no P.O. boxes or route numbers, please!). If we cannot duplicate the problem or establish the starting date of your Limited Warranty, we may, at our option, charge for service time.

Ship the product in its original shipping carton, **freight prepaid** to the authorized service center. The address of your closest authorized service center will be given to you by Technical Support, or from our website.

IMPORTANT: Make sure that the Service Request Number is plainly written on the shipping carton.

E. LOUD Technologies reserves the right to inspect any products that may be the subject of any warranty claims before repair or replacement is carried out. LOUD Technologies may, at our option, require proof of the original date of purchase in the form of a dated copy of the original dealer's invoice or sales receipt. Final determination of warranty coverage lies solely with LOUD Technologies.

F. Any products returned to one of the LOUD Technologies factory-authorized service centers, and deemed eligible for repair or replacement under the terms of this warranty will be repaired or replaced within thirty days of receipt.

LOUD Technologies and its authorized service centers may use refurbished parts for repair or replacement of any product. Products returned to LOUD Technologies that do not meet the terms of this Warranty will not be repaired unless payment is received for labor, materials, return freight, and insurance. Products repaired under warranty will be returned freight prepaid by LOUD Technologies to any location within the boundaries of the USA.

G. LOUD Technologies warrants all repairs performed for 90 days or for the remainder of the warranty period. This warranty does not extend to damage resulting from improper installation, misuse, neglect or abuse, or to exterior appearance. This warranty is recognized only if the inspection seals and serial number on the unit have not been defaced or removed.

H. LOUD Technologies assumes no responsibility for the quality or timeliness of repairs performed by an authorized service center.

I. This warranty is extended to the original purchaser and to anyone who may subsequently purchase this product within the applicable warranty period. A copy of the original sales receipt is required to obtain warranty repairs.

J. This is your sole warranty. LOUD Technologies does not authorize any third party, including any dealer or sales representative, to assume any liability on behalf of LOUD Technologies or to make any warranty for LOUD Technologies Inc.

K. THE WARRANTY GIVEN ON THIS PAGE IS THE SOLE WARRANTY GIVEN BY LOUD TECHNOLOGIES INC. AND IS IN LIEU OF ALL OTHER WARRANTIES, EXPRESS AND IMPLIED, INCLUDING THE WARRANTIES OF MERCHANTABILITY AND FITNESS FOR A PARTICULAR PURPOSE. THE WARRANTY GIVEN ON THIS PAGE SHALL BE STRICTLY LIMITED IN DURATION TO THREE YEARS FROM THE DATE OF ORIGINAL PURCHASE FROM AN AUTHORIZED MACKIE DEALER. UPON EXPIRATION OF THE APPLICABLE WARRANTY PERIOD, LOUD TECHNOLOGIES INC. SHALL HAVE NO FURTHER WARRANTY OBLIGATION OF ANY KIND. LOUD TECHNOLOGIES INC. SHALL NOT BE LIABLE FOR ANY INCIDENTAL, SPECIAL, OR CONSEQUENTIAL DAMAGES THAT MAY RESULT FROM ANY DEFECT IN THE MACKIE PRODUCT OR ANY WARRANTY CLAIM. Some states do not allow exclusion or limitation of incidental, special, or consequential damages or a limitation on how long warranties last, so some of the above limitations and exclusions may not apply to you. This warranty provides specific legal rights and you may have other rights which vary from state to state.

MACKIE®

16220 Wood-Red Road NE • Woodinville, WA 98072 • USA

United States and Canada: 800.898.3211

Europe, Asia, Central and South America: 425.487.4333

Middle East and Africa: 31.20.654.4000

Fax: 425.487.4337 • www.mackie.com

E-mail: sales@mackie.com