

ALLEN & HEATH



USER GUIDE

Publication AP6822

Limited One Year Warranty

This product is warranted to be free from defects in materials or workmanship for period of one year from the date of purchase by the original owner.

To ensure a high level of performance and reliability for which this equipment has been designed and manufactured, read this User Guide before operating. In the event of a failure, notify and return the defective unit to ALLEN & HEATH Limited or its authorised agent as soon as possible for repair under warranty subject to the following conditions

Conditions Of Warranty

The equipment has been installed and operated in accordance with the instructions in this User Guide.

The equipment has not been subject to misuse either intended or accidental, neglect, or alteration other than as described in the User Guide or Service Manual, or approved by ALLEN & HEATH.

Any necessary adjustment, alteration or repair has been carried out by ALLEN & HEATH or its authorised agent.

This warranty does not cover fader wear and tear.

The defective unit is to be returned carriage prepaid to ALLEN & HEATH or its authorised agent with proof of purchase.

Units returned should be packed to avoid transit damage.

In certain territories the terms may vary. Check with your ALLEN & HEATH agent for any additional warranty which may apply.

This product complies with the European Electro magnetic Compatibility directives 89/336/EEC & 92/31/EEC and the European Low Voltage Directives 73/23/EEC & 93/68/EEC.

This product has been tested to EN55103 Parts 1 & 2 1996 for use in Environments E1, E2, E3, and E4 to demonstrate compliance with the protection requirements in the European EMC directive 89/336/EEC. During some tests the specified performance figures of the product were affected. This is considered permissible and the product has been passed as acceptable for its intended use. Allen & Heath has a strict policy of ensuring all products are tested to the latest safety and EMC standards. Customers requiring more information about EMC and safety issues can contact Allen & Heath.

ZED 14 User Guide AP6822 Issue 3

Copyright © 2007 Allen & Heath Limited. All rights reserved

Allen & Heath Limited

Kernick Industrial Estate, Penryn, Cornwall, TR10 9LU, UK

<http://www.allen-heath.com>

PACKED ITEMS

Check that you have received the following:

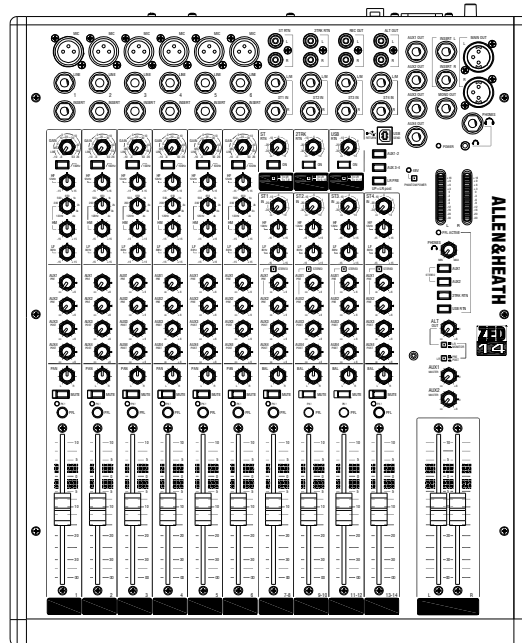

ZED-14 MIXER

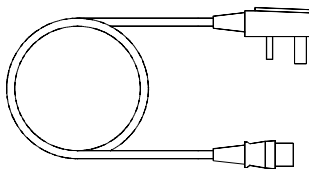

Mains Lead

Check that the correct mains plug is fitted.

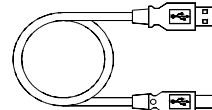

Type A-B USB Lead

To connect the ZED to your computer.

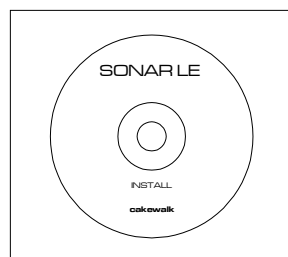

SONAR LE

Music Software Install disk.

SAFETY INSTRUCTIONS

WARNINGS - Read the following before proceeding :



ATTENTION: RISQUE DE CHOC ELECTRIQUE – NE PAS OUVRIR

Read instructions: Retain these safety and operating instructions for future reference. Adhere to all warnings printed here and on the console. Follow the operating instructions printed in this User Guide.

Do not remove cover: Operate the console with its covers correctly fitted.

Power sources: Connect the console to a mains power unit only of the type described in this User Guide and marked on the rear panel. Use the power cord with sealed mains plug appropriate for your local mains supply as provided with the console. If the provided plug does not fit into your outlet consult your service agent for assistance.

Power cord routing: Route the power cord so that it is not likely to be walked on, stretched or pinched by items placed upon or against it.

Grounding: Do not defeat the grounding and polarisation means of the power cord plug. Do not remove or tamper with the ground connection in the power cord.



WARNING: This equipment must be earthed.

Water and moisture: To reduce the risk of fire or electric shock do not expose the console to rain or moisture or use it in damp or wet conditions. Do not place containers of liquids on it which might spill into any openings.

Ventilation: Do not obstruct the ventilation slots or position the console where the air flow required for ventilation is impeded. If the console is to be operated in a rack unit or flightcase ensure that it is constructed to allow adequate ventilation.

Heat and vibration: Do not locate the console in a place subject to excessive heat or direct sunlight as this could be a fire hazard. Locate the console away from any equipment which produces heat or causes excessive vibration.

Servicing: Switch off the equipment and unplug the power cord immediately if it is exposed to moisture, spilled liquid, objects fallen into the openings, the power cord or plug become damaged, during lightning storms, or if smoke, odour or noise is noticed. Refer servicing to qualified technical personnel only.

Installation: Install the console in accordance with the instructions printed in this User Guide. Do not connect the output of power amplifiers directly to the console. Use audio connectors and plugs only for their intended purpose.

SAFETY INSTRUCTIONS

Important Mains plug wiring instructions

The console is supplied with a moulded mains plug fitted to the AC mains power lead. Follow the instructions below if the mains plug has to be replaced. The wires in the mains lead are coloured in accordance with the following code:



TERMINAL		WIRE COLOUR	
		European	USA/Canada
L	LIVE	BROWN	BLACK
N	NEUTRAL	BLUE	WHITE
E	EARTH GND	GREEN & YELLOW	GREEN

The wire which is coloured Green and Yellow must be connected to the terminal in the plug which is marked with the letter E or with the Earth symbol. This appliance must be earthed.

The wire which is coloured Blue must be connected to the terminal in the plug which is marked with the letter N.

The wire which is coloured Brown must be connected to the terminal in the plug which is marked with the letter L.

Ensure that these colour codes are followed carefully in the event of the plug being changed.

General Precautions:

Damage :

To prevent damage to the controls and cosmetics avoid placing heavy objects on the control surface, scratching the surface with sharp objects, or rough handling and vibration.

Environment :

Protect from excessive dirt, dust, heat and vibration when operating and storing. Avoid tobacco ash, smoke, drinks spillage, and exposure to rain and moisture. If the console becomes wet, switch off and remove mains power immediately. Allow to dry out thoroughly before using again.

Cleaning :

Avoid the use of chemicals, abrasives or solvents. The control panel is best cleaned with a soft brush and dry lint-free cloth. The faders, switches and potentiometers are lubricated for life. The use of electrical lubricants on these parts is not recommended. The fader and potentiometer knobs may be removed for cleaning with a warm soapy solution. Rinse and allow to dry fully before refitting them.

Transporting :

The console may be transported as a free-standing unit or mounted in a rack or flightcase. Protect the controls from damage during transit. Use adequate packing if you need to ship the unit.

Hearing :

To avoid damage to your hearing do not operate any sound system at excessively high volume. This applies particularly to close-to-ear monitoring such as headphones and in-ear systems. Continued exposure to high volume sound can cause frequency selective or wide range hearing loss.



CONTENTS

Thank you for purchasing your Allen & Heath ZED-14 mixer. To ensure that you get the maximum benefit from the unit please spare a few minutes familiarizing yourself with the controls and setup procedures outlined in this user guide. For further information please refer to the additional information available on our web site, or contact our technical support team.

<http://www.allen-heath.com>

Warranty	3
Packed Items.....	4
Safety Instructions	5
Contents.....	7
Panel Drawings.....	8
Introduction to ZED-14.....	9
Specifications	9
Dimensions	11
Block Diagram.....	12
Mono Input Channel	13
Stereo Input Channel.....	16
USB and Master Section.....	19
USB Connection	21
SONAR LE software introduction .	22
SONAR LE installation	23
Configuring SONAR LE with ZED.	24
Application Information—Live	26
Application Information—Studio....	27
Using USB for effects	28
Wiring Notes.....	29
Product Support	30

PANEL DRAWINGS

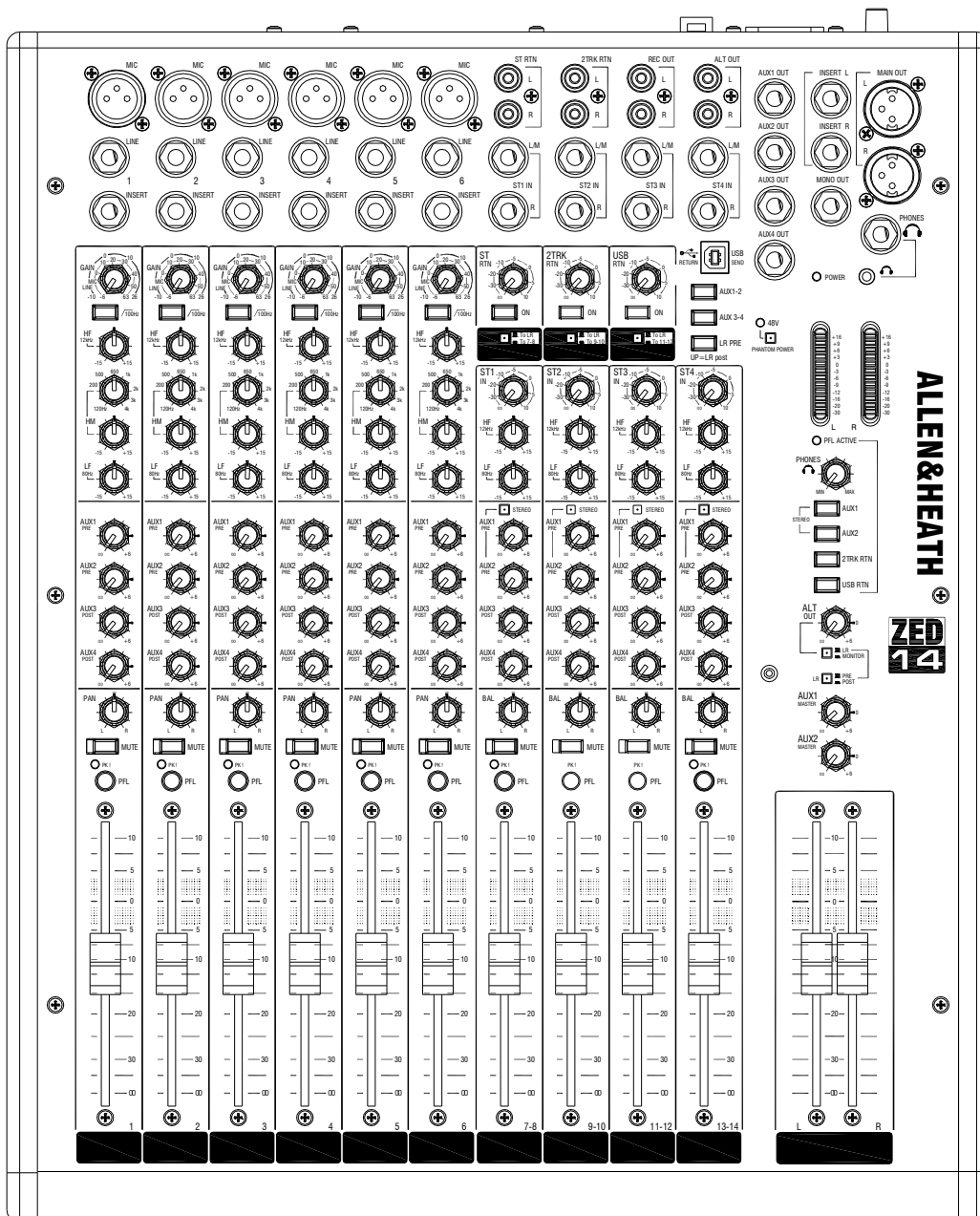

INTRODUCTION TO THE ZED-14

The following is a bit technical, so if you want to, please skip to the next section!

The Allen & Heath ZED-14 mixer has been carefully and lovingly designed in the beautiful county of Cornwall in the UK and is manufactured alongside a wide range of professional audio mixing consoles. Many of the components used in ZED are exactly the same as in the larger Allen & Heath products and the construction methods are also very similar — utilising individual vertically mounted channel circuit boards with each rotary control fixed with a metal nut to the front panel. This provides a very robust product that will resist damage and give years of reliable use. It also makes servicing much easier should it be required, with the ability to remove one particular channel from the mixer at a time, or easily change a fader.

The audio circuitry is based on years of continual development and refinement and the performance of all the elements within the mixer scrutinised and perfected to ensure the very best sound quality possible.

Mic/Line Pre-amps:

Based on the pre-amps from the PA series, the ZED series pre-amps use a two stage design, with carefully controlled amounts of gain in each stage. When amplifying the signal from the XLR input, the gain range is huge — 69dB of range to be exact — and is very evenly distributed around the gain control, meaning better control of signal level. Most of the gain comes from the first stage, so unwanted noise is kept to a minimum. There is no “pad” switch, or pad circuit — line level signals are simply plugged into the second stage of the pre-amp by using the line input jack socket. This has the great advantage of lower noise when using the line input. (It is common to attenuate line level signals, then amplify them back up again which can give more noise or hiss).

EQ:

The ZED series mixers are equipped with a 3-band equaliser circuit on each mono input and a 2-band EQ on the stereo channels. The frequency and response of each has been carefully chosen to give the maximum performance when using the EQ on a variety of sources.

AUX system:

Four auxiliary buses are provided, two pre-fade and two post fader. Auxes 1 & 2 have master level controls.

Mono and Stereo Channels:

One of the great things about the ZED series is the number and variety of things you can plug in. In addition to the six mono channels there are four stereo channels, each with a main stereo input on jack sockets, and with the ability to take additional stereo inputs from phono sockets or from the USB audio input, flexibility gives you control.

USB:

Getting audio to and from a computer easily is now a common requirement for live sound and music production. The way we have implemented this on ZED is super-flexible and super-easy! No longer do you need to fiddle around the back of your PC to get to the soundcard inputs, only to find that the levels are all wrong and noisy. Just plug in a USB lead to your ZED, select the USB routing on the mixer and the device on your computer and that's it! Quality audio to and from your PC or MAC.

As you can tell, we're very proud of this product we hope you like it too!

SPECIFICATIONS

Operating Levels

Operating Levels	
Input	
Mono channel (XLR) Input	+6 to -63dBu for nominal (+17dBu in max)
Mono channel Line Input (Jack socket)	+10 to -26dBu (+30dBu maximum)
Insert point (TRS Jack socket)	0dBu nominal +21dBu maximum
Stereo Input (Jack sockets)	0dBu nominal (control = Off to +10dB)
Stereo input (phono sockets)	0dBu nominal (control = Off to +10dB)
Output	
L, R & Mono Outputs (L&R XLR, Mono Jack)	0dBu nominal. +21dBu maximum.
Aux Outputs (Jack sockets)	0dBu nominal. +21dBu maximum.
Alt Outputs (phono sockets)	0dBu nominal. +21dBu maximum.
Rec Outputs (phono sockets)	0dBu nominal. +21dBu maximum.

Frequency Response

Mic in to Mix L/R Out, 30dB gain	+0.5/-1dB 20Hz to 20kHz.
Line in to Mix L/R out 0dB gain	+0.5/-1dB 10Hz to 30kHz
Stereo in to Mix L/R out	+0.5/-1dB 10Hz to 30kHz

THD+n

Mic in to Mix L/R Out, 0dB gain 1kHz +10dBu out	0.004%
Mic in to Mix L/R Out, 30dB gain 1kHz	0.014%
Line in to Mix L/R out 0dB gain 0dBu 1kHz	0.005%
Stereo in to Mix L/R out 0dB gain +10dBu 1kHz	0.003%

Headroom

Analogue Headroom from nominal (0Vu)	21dB
USB in & out headroom from nominal (0Vu)	14dB

USB Audio CODEC (Coder/Decoder)

USB Audio In/Out	USB I.1 compliant 16bit.
Sample Rate	32, 44.1, or 48kHz

Noise

Mix L/R out, L/R faders = 0, 22-22kHz	-88dBu
Mic Pre EIN @ max gain 150R input Z 22-22kHz	-127dBu

Dimensions

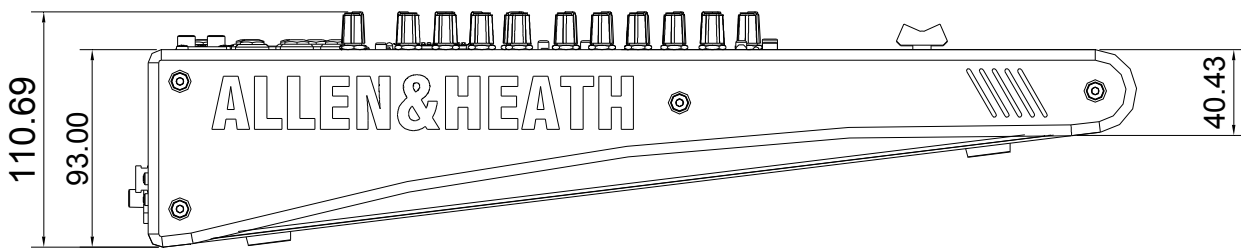
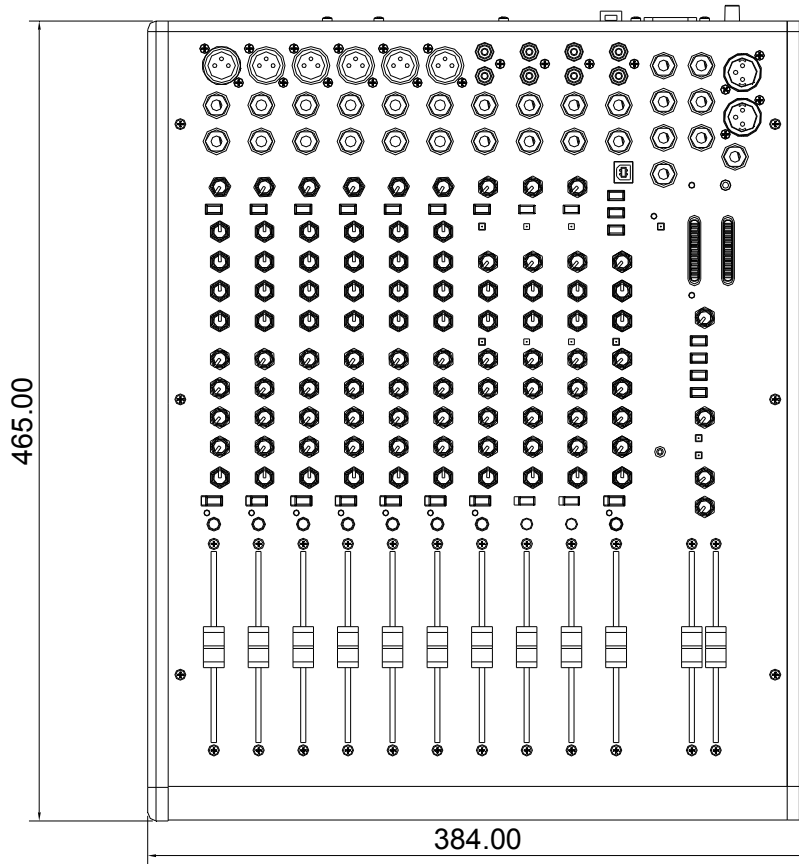

Weight	
Unpacked	6.5kg (14.3lb)
Packed	8.5kg (18.7lb)

BLOCK DIAGRAM

ZED 14 BLOCK DIAGRAM

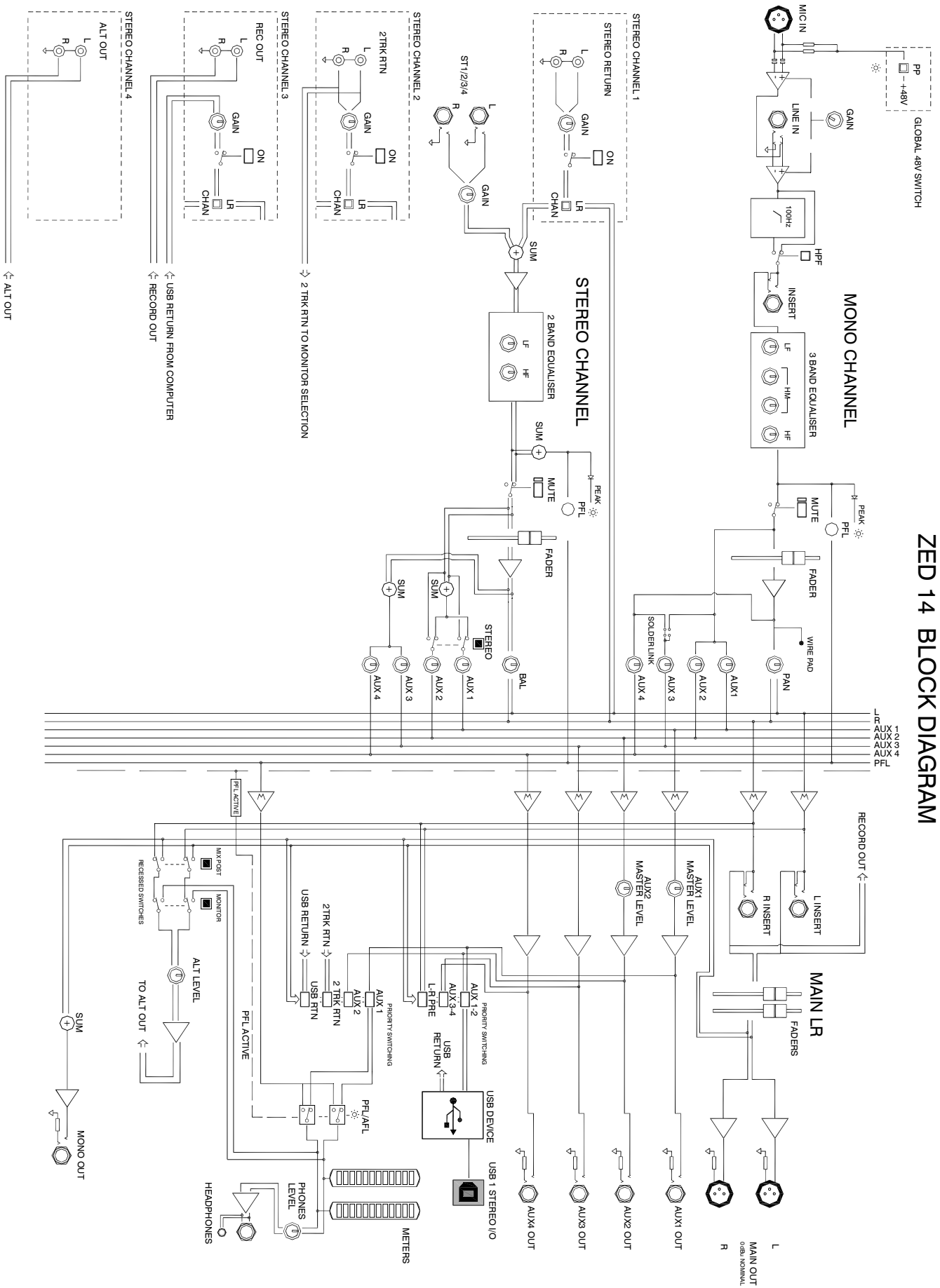

MONO INPUT CHANNEL

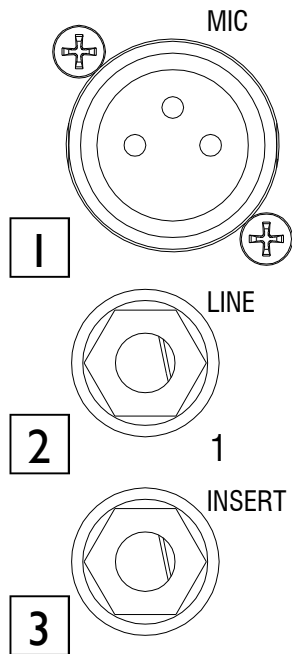

1 Mic Input Socket

Standard 3-Pin XLR socket wired as Pin 1=Chassis, Pin 2=hot (+), Pin 3=Cold (-).

2 Line Input Jack Socket

Standard 1/4" (6.25mm) Jack socket for balanced or unbalanced line level signals. Wired Tip=Hot(+), Ring=cold (-), Sleeve=Chassis.

The Line input overrides the Mic input, so if you want to hear something plugged in to the xlr socket, make sure nothing is plugged into the Line input.

3 Insert Jack Socket

Standard 1/4" (6.25mm) Jack socket for unbalanced insert send and return signals. Wired Tip=send, Ring=return, Sleeve=Chassis. Nominal level is 0dBu. The insert point is after the 100Hz filter and before the EQ.

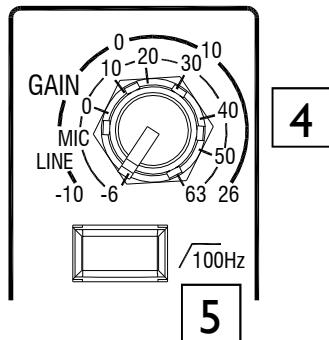

4 Gain Control

This adjusts the gain of the input amplifier to match the signal level of the input. The gain is varied from -6dB (attenuation) to +63dB for signals plugged in to the xlr socket (Mic Input) and -10dB to +26dB for signals plugged into the Line input jack.

5 100Hz Hi-pass Filter

The Hi-pass filter is used for reducing pop noise and rumble from microphone signals. It is a 2-pole (12dB per octave) filter with a corner frequency set at 100Hz.

The filter affects signals from both Mic XLR and Line jack socket.

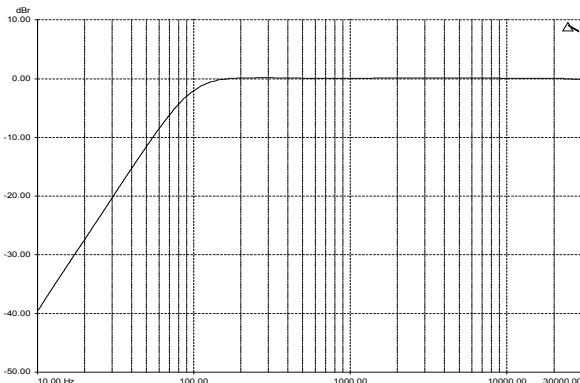

MONO INPUT CHANNELS I TO 6

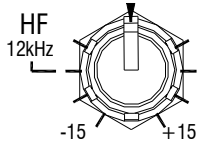
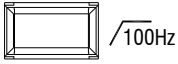
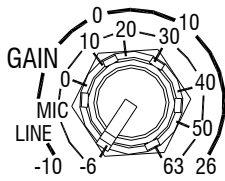

6

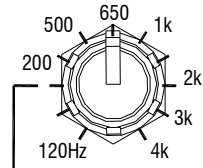

7

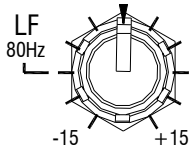
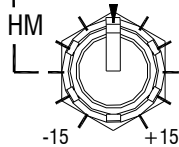

8

8

LF EQ

The LF (Low Frequency) equaliser affects the response at the low end of the audio range. The graph shows the response of the LF EQ at maximum cut and boost. The corner frequency is 80Hz.

6 HF EQ

The HF (High Frequency) equaliser affects the frequency response of the higher audible frequencies. The corner frequency of 12kHz is around 3dB from the maximum cut or boost of the circuit. It has plenty of gain and actually gives slightly more than the +/- 15dB legend suggests.

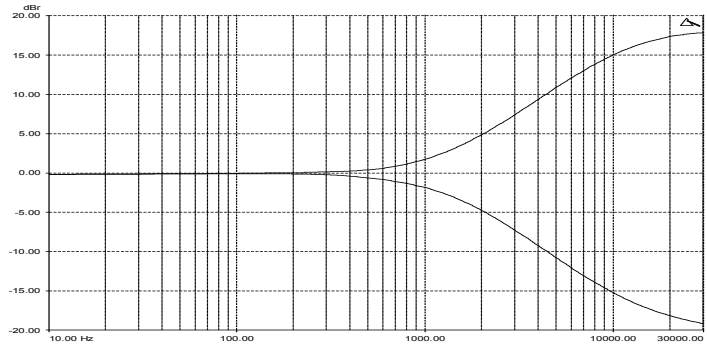

7

7 MF EQ

The MF (Mid Frequency) equaliser affects the middle of the audible frequency range. The frequency graduations on the sweep control are the centre frequencies of the EQ. The range has been carefully chosen to cover "boomy" frequencies around 120Hz to 250Hz which may need cutting back, or a lift at 2 to 3kHz may be required for microphone intelligibility.

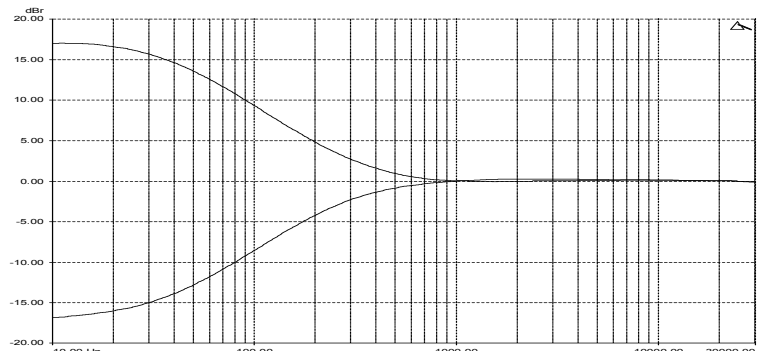
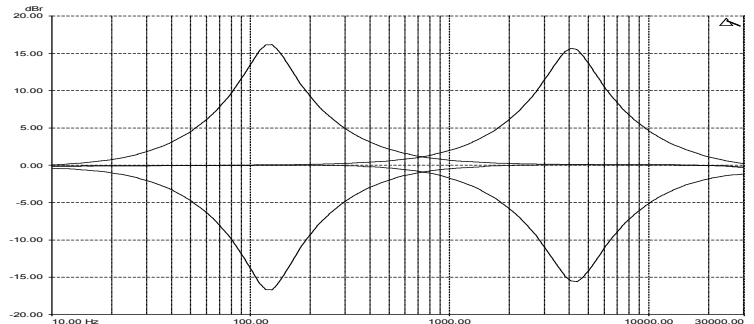

MONO INPUT CHANNELS 1 TO 6

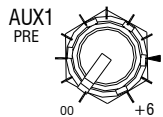

9

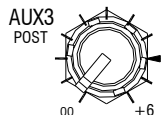
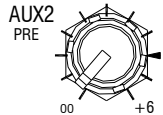

10

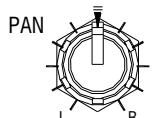
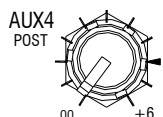

11

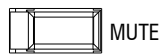

12



13



14

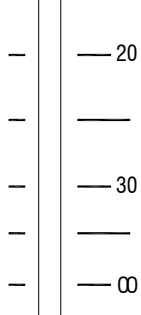
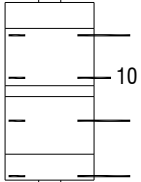
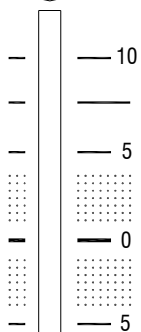

1

9 Auxes 1 & 2

Each of these controls sends a signal to an auxiliary bus. The signal is sourced pre-fade which means that the level is independent of, and unaffected by the fader. Auxes 1 & 2 are primarily used for foldback monitoring purposes, as the fader does not affect the level. They can also be used as feeds for recording and are available sources to the USB interface for this purpose.

These sends are affected by the Mute switch, so muting the channel will also mute the Aux sends.

The control varies the signal level to the bus from off (fully attenuated) to +6dB, with unity gain at the arrow.

10 Auxes 3 & 4

These are post-fade sends, which means that the signals are affected by the channel fader. Primarily used for effects sends, the aux signal will reduce if the fader is pulled down so keeping the correct proportion of the effect.

Muting the channel will also mute the Aux sends, and the send controls have 6dB gain fully clockwise.

There are no master level controls for Aux 3 & 4 outputs.

11 PAN

The pan control adjusts how the signal from the mono input channel is shared between the left and right buses and subsequently the main stereo outputs. Set to the mid position, equal amounts of signal are fed to left and right, with pan set to L, none is sent to the Right bus.

12 Mute Switch

This mutes or cuts the signal to the left & right buses and the Aux buses. A rectangular LED illuminates to show the Mute switch is pressed.

13 PFL Switch & PK! LED

The PFL (Pre-Fade Listen) switch sends the channel signal to the PFL bus and subsequently to the headphones and the main L R meters. Used for checking the audio signal before raising the fader or un-muting the channel.

The PK! LED illuminates dimly to indicate the PFL switch is pressed, and brightly to indicate the channel signal is within 5dB of clipping.

14 Fader

The 100mm fader affects the level of the channel signal to the left & right buses and Auxes 3 & 4. There is 10dB of gain at the top and the unity gain position is marked by "0".

STEREO INPUT CHANNEL 7-8

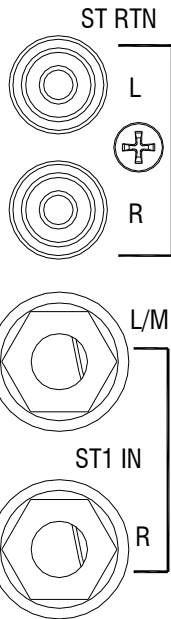

1

5

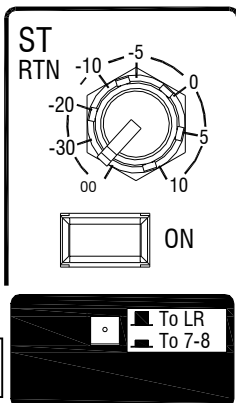

2

3

4

8

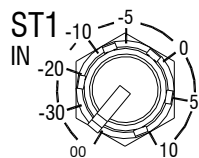

6

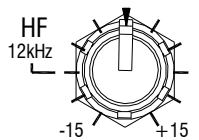

7

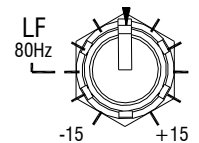

1 Stereo Return Phono sockets

This is an additional stereo input to the main stereo channel input (below). The gain is varied by the ST RTN control and this input can be sent to either the stereo channel or straight to the L R main bus, depending on the setting of the under-panel switch. These inputs are unbalanced.

2 Stereo Return Level control

Adjusts the level of the stereo return input from off (fully attenuated) to maximum where it has 10dB of gain.

3 Stereo Return ON switch

This switches the signal on when pressed in. Leaving the switch in the up position is recommended when the stereo return input is not in use to minimise unwanted noise being passed through.

4 Stereo Routing selector switch

This switch selects whether the Stereo Return signal is sent to the L R bus directly, or the stereo channel I. When it is pressed in, the Stereo Return signal sums together with the main stereo input.

5 Stereo I input jack sockets

Standard 1/4" jack sockets for line level stereo signals. Can be used with a mono input where the L/M input will also connect to the R input if nothing is plugged in to R. The Stereo I inputs accept unbalanced or balanced signals.

6 Stereo I Level control

Adjusts the level of the STI input. The range is from off to +10dB.

7 Stereo Channel EQ

The Stereo Channel EQ is 2 band with centre frequencies of 12kHz for the HF and 80Hz for the LF.

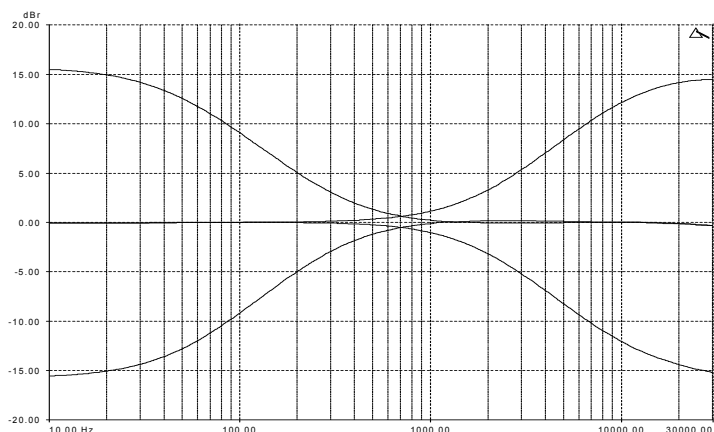

STEREO CHANNEL 7-8

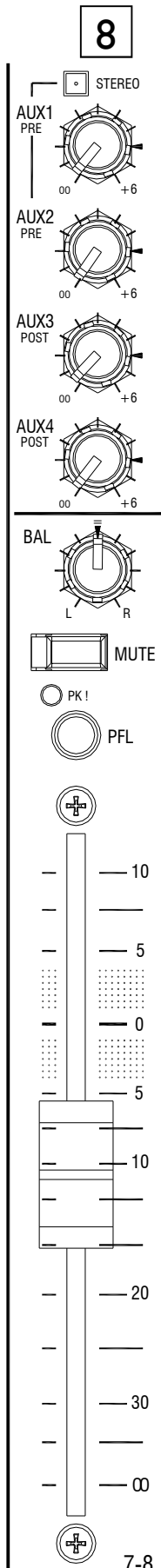

8

STEREO Aux 1 & 2 switch

This is an under-panel selector switch that configures Auxes 1 & 2 to be either mono sends or a stereo send pair.

UP: A mono sum of the left & right stereo channel signal is sent to Aux buses 1 & 2 by the control knobs.

DOWN: The left stereo channel signal is sent to Aux 1 and the right is sent to Aux 2 by the control knobs.

Note: This can be useful when setting up a separate stereo output from the main L R output using Auxes 1 & 2, possibly for recording. This can be selected to feed the USB output to create an independent stereo feed for recording using a computer.

9

9

Aux 1 & 2 sends

These control the level of the signals sent to the Aux 1 & 2 buses. The Aux 1 & 2 send controls are configured either as two mono sends or as a stereo pair depending on the position of the STEREO switch (please see above).

Auxes 1 & 2 are pre-fade, but muted when the Mute switch is pressed. There is 6dB of gain at the fully clockwise position.

10

10

Aux 3 & 4 sends

These controls take a mono sum of the left & right stereo channel signals from after the fader and send them to the Aux 3 and Aux 4 buses respectively. They are muted when the Mute switch is pressed and have 6dB of gain at maximum.

11

11

Balance control

The Balance control varies the relative levels between the left and right channels.

12

12

Mute Switch

Mutes the signals to the main L R and the Aux buses.

13

13

PFL Switch & PK! LED

The Pre-Fade Listen switch takes a mono sum of the stereo channel signals from before the fader and mute switch. When pressed the signal will appear on the L R meters and be fed to the headphones circuit for monitoring.

The PK! LED illuminates dimly to indicate the PFL switch is pressed, and brightly to indicate the channel signal is within 5dB of clipping.

14

14

Fader

The 100mm fader affects the level of the channel signal to the left & right buses and Auxes 3 & 4. There is 10dB of gain at the top and the unity gain position is marked by "0".

STEREO INPUT CHANNELS 9-10, 11-12, 13-14

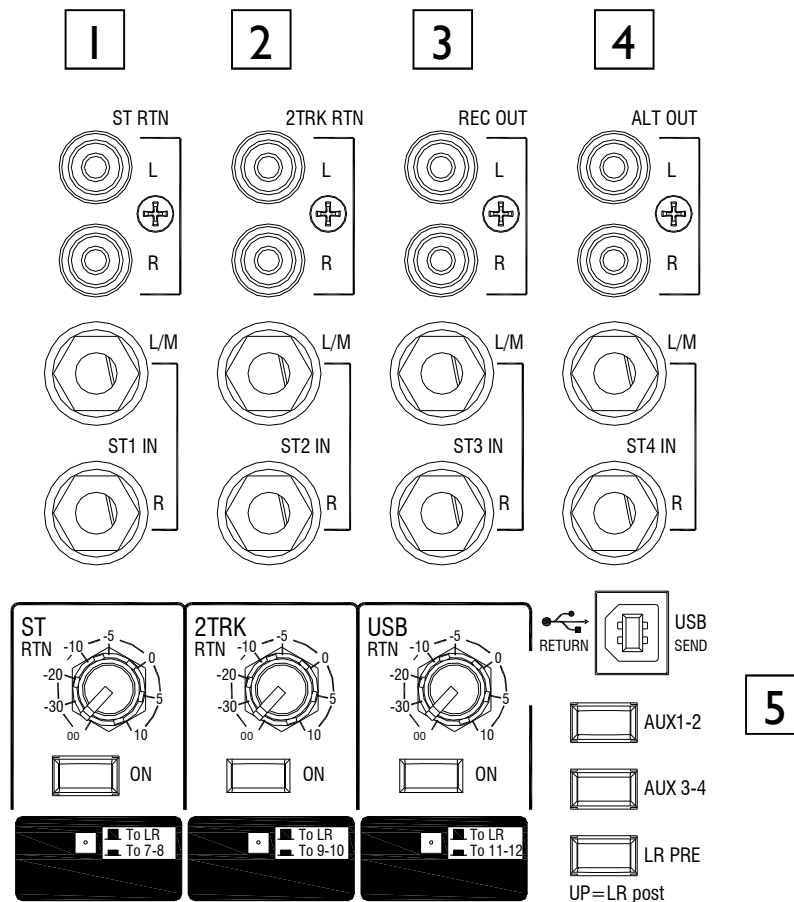

- 1 Stereo Input Channel 7-8**
This is stereo input channel 7-8 as described on pages 12 & 13.
- 2 Stereo Input Channel 9-10**
The only difference from stereo input channel 7-8 is the labelling of the additional stereo input on phono connectors, labelled as 2 Track Return. This is to indicate that a 2 track (stereo) input can be inserted here for playback of a stereo recording or incidental music.
- 3 Stereo Input Channel 11-12**
Stereo input channel 11-12 also has an additional stereo input, but instead of being on phono connectors, it comes from the USB audio input. The level control, ON switch and routing switch are the same as for stereo input channel 7-8. It is best to leave the ON switch in its UP position when the USB input is not in use. The phono sockets carry the analogue record output signals that are sourced from the main L R outputs. They are pre-fade, post L R insert.
- 4 Stereo Input Channel 13-14**
Stereo input channel 13-14 has one stereo input (ST 4) on jack sockets. The phono sockets carry the Alternate stereo output which comes from the selector switches and level control in the master section.
- 5 USB connector & output selection.**
A standard USB type B connector plugs in here (cable supplied). The three selector switches determine what is sent on the USB output. They work on a priority system, so that if more than one is pressed the one nearest the top takes precedence. So if all 3 are pressed, then the Aux 1 & 2 signals would be sent by the USB device. Please refer to the section describing using the USB audio port for more details.

USB & MASTER SECTION

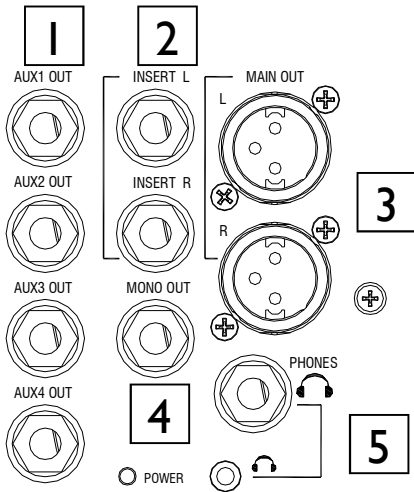

- 1 Aux output jack sockets**
Standard 1/4" jack sockets for Aux 1 to 4 outputs. Impedance balanced, nominal level = 0dBu.
- 2 Mix L R Insert jack sockets**
Standard 1/4" (6.25mm) Jack sockets for unbalanced insert send and return signals. Wired Tip = send, Ring = return, Sleeve = Chassis. Nominal level is 0dBu.
- 3 Main L R output xlr sockets**
Main left & right outputs. Impedance balanced signals, pin1 = chassis, pin2 = hot (+), pin3 = cold (-). Nominal level = 0dBu.

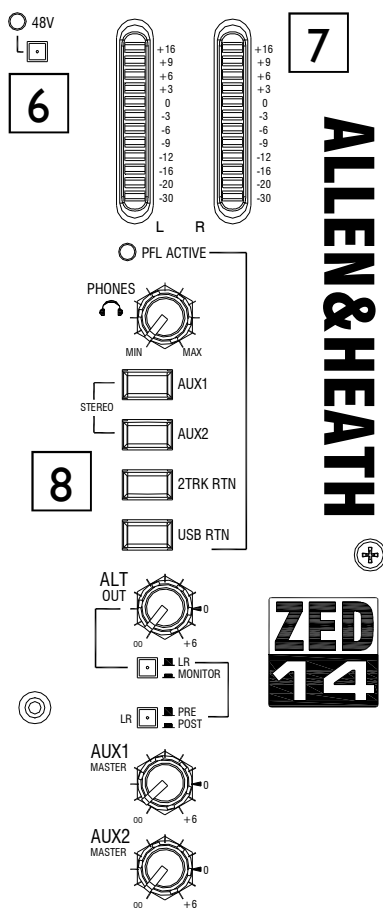

- 4 Mono output jack socket**
A mono sum of the main left & right post-fade signals.
- 5 Headphones jack sockets**
One 1/4" and one 3.5mm jack socket for stereo headphones. Wired Tip = left, Ring = right, Sleeve = Chassis. It is recommended that headphones with an impedance higher than 30ohms are used.
- 6 48v Phantom Power switch**
Press this in to switch 48v Phantom Power to all the Mic input xlr connectors, if any of the microphones attached require power. Dynamic microphones won't mind being connected to a phantom powered input, but care is needed to ensure that 48v is not switched on if an xlr is used to input a signal from an electronic circuit (ie. Another mixer or keyboard).
When switching 48v on or off, or plugging in connectors to channels with 48v present, it is important (and normal practise) to mute the channels. This will avoid loud clicks and bangs potentially getting through to the amps & speakers with the possible effect of damaging the speakers, or your audience's hearing!



- 7 Left Right meters**
12 segment LED meters, peak type response, the "0" position reflects 0dBu at the outputs. These display the signals from the monitor selector switches below, or the PFL (pre-fade listen) signals from any selected channels, which overrides.

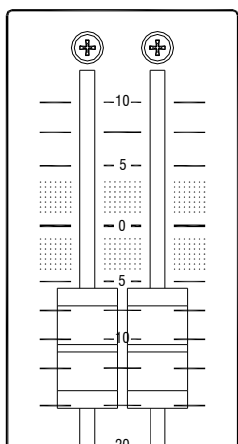

USB & MASTER SECTION

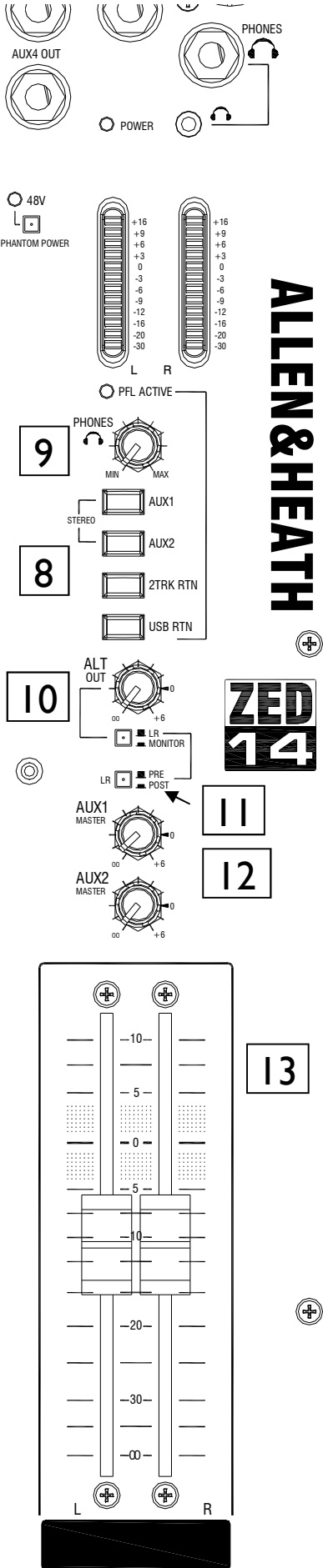

8 Monitor selector switches
 These 4 switches select the signal source for the headphones monitor and the meters. They work on a priority basis. If they are all up then the post-fade main L R signals will feed the monitor circuit, if USB and 2 TRK are pressed, then only the 2 TRK signals will feed the monitor circuit. The stereo option of pressing both AUX 1 and AUX 2 together allows Aux 1 to feed the left and Aux 2 to feed the right monitor circuit. This is useful if a stereo mix is set up using Auxes 1 & 2.

9 Headphone level control
 Adjusts the level of the headphone signal.

Warning ! To avoid damage to your hearing do not operate the headphones or sound system at excessively high volume. Continued exposure to high volume sound can cause frequency selective or wide range hearing loss.

10 Alternate output level control
 The Alt (Alternate) Output is useful for connecting a pair of monitor speakers separate to the main outputs. The level control adjusts the volume of the output from off to +6dB.

11 Alternate output selector switches
 These under-panel switches select the signal source for the Alt output. They select between the L R pre-fade, L R post-fade or the monitor L R signals.

12 Aux 1 & 2 master level controls
 For adjusting the level of the Aux 1 and 2 outputs. The range of level control is from off to +6dB.

13 Master L R faders
 High quality 100mm faders for the main L R outputs. 10dB gain at the top, unity gain marked at "0".

USB CONNECTION

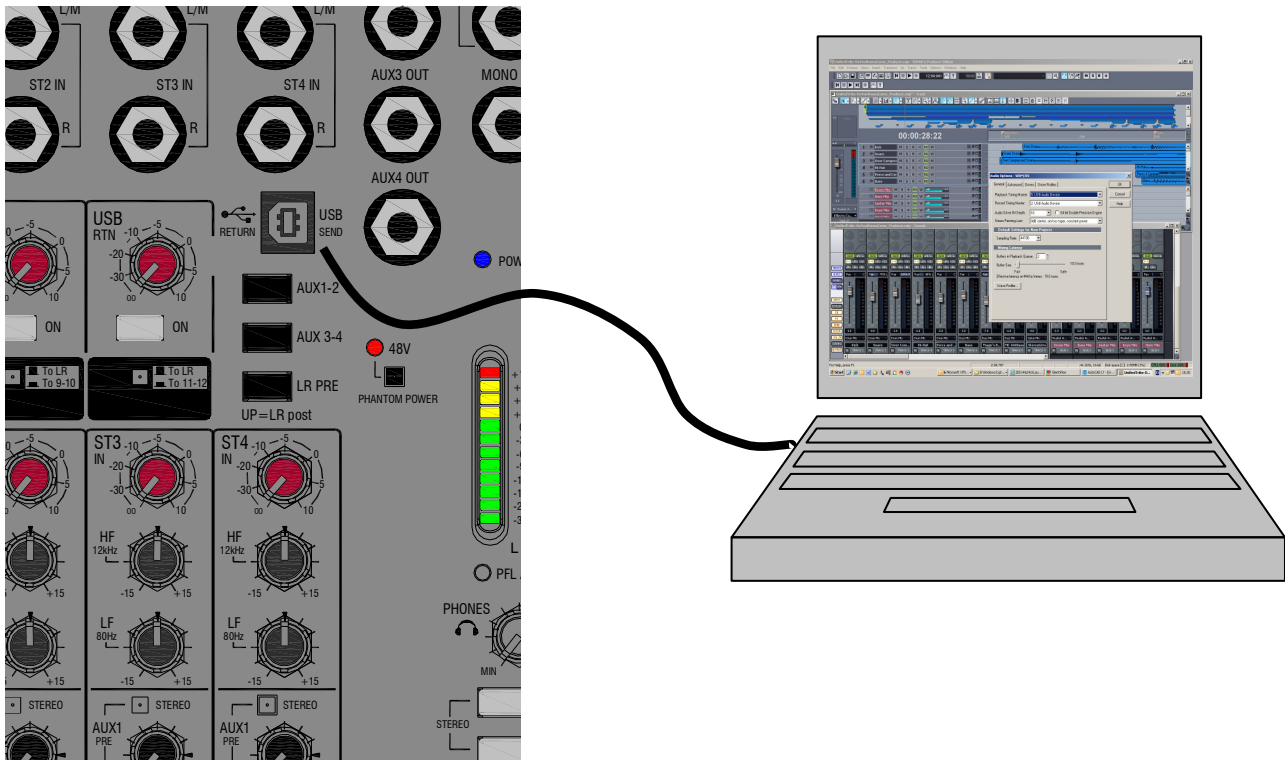

USB Audio Interface

The ZED is equipped with a stereo bi-directional USB I.1 compliant audio CODEC. It is fully compliant with USB 2 ports and uses standard Windows and MAC Core Audio Drivers. In other words, plug it in and your computer will find it and be able to transfer audio to and from the ZED USB device.

You will need some form of audio software running on your computer to be able to record and play back what you record, but on a basic level, you can use your computers media player to play straight to the ZED device.

Just a couple of points to look out for:

1. When you plug in your ZED USB interface to your computer, check the device volume in:

Control Panel\Sounds & Audio Devices\Volume

If the volume is not fully up

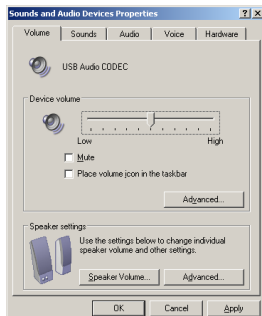

Then drag it fully up like this.....

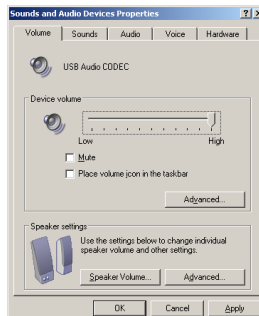

Then click **Apply**

2. If you want to reduce latency (delay) there are some different drivers available for your operating system. Please check the Allen & Heath website www.allen-heath.com for details and links to third party companies able to supply appropriate drivers for your operating system.



cakewalk SONAR LE

DIGITAL AUDIO WORKSTATION

SONAR LE Overview.

SONAR LE is a software application from Cakewalk and is included free of charge with your new ZED mixing console.

SONAR LE is a powerful first step into the world of sequencing and hard disk recording on the Windows platform. You'll be able to record from your ZED mixer, create tracks and arrange songs, then play back to your ZED mixer via the USB port. You can decide whether the SONAR family of products is right for you. If you choose to upgrade your copy of SONAR LE to a more full-featured version, like SONAR Producer or Home Studio Editions, you'll now be able to do so at significant savings.

We will describe the basic steps of installing the software and getting started here, for more comprehensive help or technical support please use the Help files in SONAR LE or visit the SONAR LE website:

<http://www.cakewalk.com/owners/sonarle/>

The website will have details on registering your product and upgrading it should you wish. There are also tutorials to get you started.

SONAR LE is the most complete OEM production software solution available today. Unlike other OEM applications, SONAR LE has been designed to provide a simple yet complete solution for creating music. You won't feel the need to upgrade just to get started.

With support for up to 64 tracks and 24 track effects, 8 physical in/outs at 24bit/192kHz, SONAR LE is able to offer a powerful pc based recording studio. The package also includes 2 instruments, 6 MIDI effects, and 14 audio effects. SONAR LE has been updated with new features from its acclaimed SONAR 6, making SONAR LE the first native Windows DAW for Windows XP, Windows x64, and Windows Vista.

Today's Cakewalk SONAR LE is the definitive choice for creating the most complete hardware and software solution.

SONAR LE Key Features.

64 audio tracks

256 MIDI tracks

8 simultaneous inputs and outputs

24-bit/192 kHz audio quality

24 simultaneous effects

8 simultaneous virtual instruments

Integrated VST/VSTi support, without need for VST adapter

Support for ACID™-format loops

Support for ReWire clients such as Project5, Live, or Reason

Elegant user interface—NEW

Active Controller Technology™ automatically maps MIDI keyboards and control surfaces to the parameters you need most on effects, instruments, volume, pan, and other mix elements—NEW

Easier integration of virtual instruments with Synth Rack—NEW

Support for Windows Vista (32-bit & 64-bit) —NEW , Windows XP Professional x64 Edition—NEW, and Windows XP operating systems

System Requirements.

System Requirements	Minimum	Recommended
Operating System	Windows XP	Windows XP/Vista/Vista x64
Processor Speed	Intel® Pentium® 4 1.3 GHz, or AMD™ Athlon XP 1500+ or higher	Intel® Pentium® 4 2.8 GHz [EM64T], or AMD™ Athlon 64 2800+ or higher
RAM	256 MB	1 GB or higher
Graphics (resolution, color depth)	1024 x 768, 16-bit color	1280 x 960, 32-bit color
Hard Disk Space	100 MB for core program	2 GB for program and content
Hard Disk Type	Any	EIDE/Ultra DMA (7200 RPM) or SATA
MIDI Interface	Windows-compatible	Windows-compatible
Audio Interface	Windows-compatible	WDM- or ASIO-compatible, including WaveRT for Vista
Optical Drive	DVD-ROM, DVD+/-R, or DVD+/-RW for installation, CD-R or CD-RW capability required for CD audio disc burning	

SONAR LE Installation.

Put disk into CD or DVD ROM drive and follow instructions on screen!

SONAR LE Audio Configuration with ZED-I4.

To configure your SONAR LE software to communicate audio to and from your ZED mixing console, follow the sequence below.

Ensure the ZED mixing console is powered on.

Connect the USB lead from the computer to the USB port on ZED.

First check that your computer has recognised the connection of the ZED USB device by clicking Settings/Control Panel/Sounds and Audio Devices.

The device name should be USB Audio CODEC (ensure there are no other external audio devices attached to the computer).

Also ensure the Device Volume is set to High.

This can default to the middle during connection which means very low volume from the USB device, so it's worth checking the first few times you connect.

The properties window should look like this:

It is also a good idea to select "No Sounds" in the Sounds window.

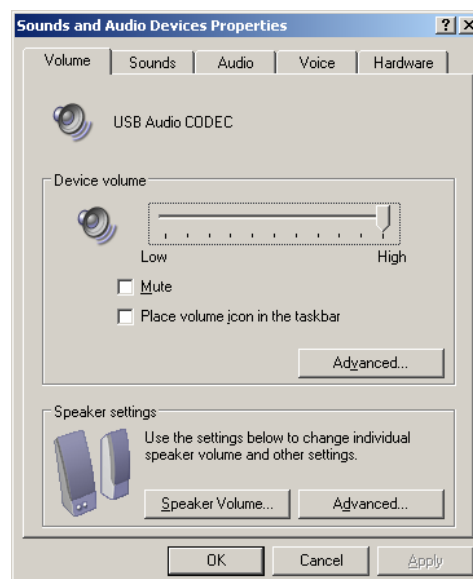

Next, fire up SONAR LE.

Click Options/Audio and click on the Drivers tab.

The Input drivers are the audio sources to the computer, here we have enabled the USB Audio Device which is the ZED mixing console USB device, and disabled the audio from the soundcard in the pc. So the computer is set up to receive audio from ZED.

The Output Drivers are the audio outputs from the computer. Here you can see that the pc soundcard has 4 stereo outputs (all disabled) and the software has located the USB Audio Device which is ZED. Tick to enable it.

You will now be able to select your ZED USB left & right outputs as inputs to SONAR LE and be able to send audio to your ZED from SONAR outputs.

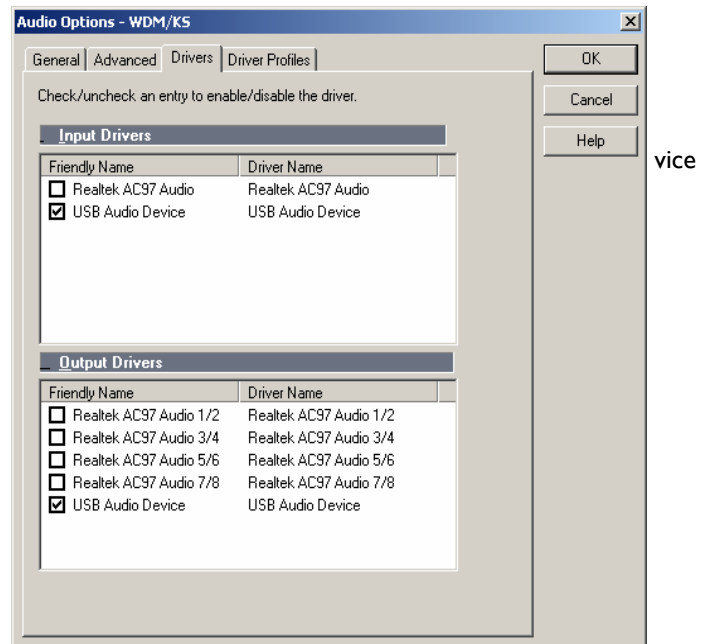

In order to show how to select inputs to SONAR tracks, here is a basic Cakewalk project (.cwp). This is created by clicking File/New/Normal and then inserting a second audio track by clicking Insert/Audio Track from the main toolbar.

Click on the I/O tab near the bottom of the window, then click the expand buttons in the audio track panes. The tracks 1 & 2 have been re-named ZED Left and ZED Right by double clicking the name field. Click the I and the O fields to select inputs and outputs for the track. Here we have selected the USB Left signal to go to Track 1 (ZED Left) and the USB Right signal to go to track 2 (ZED Right), panned them accordingly and selected the track outputs to be the Master Bus.

If audio is present, click the Input Echo buttons (lit up yellow here) to monitor the signals on the Master Bus.

The output for the Master Bus is displayed in the field marked "O" in the Master Bus pane below the input tracks. You can see here it says USB Audio Device, which is the ZED USB input. SONAR will configure this automatically if there is only one output device enabled in the Output Drivers Options window (above).

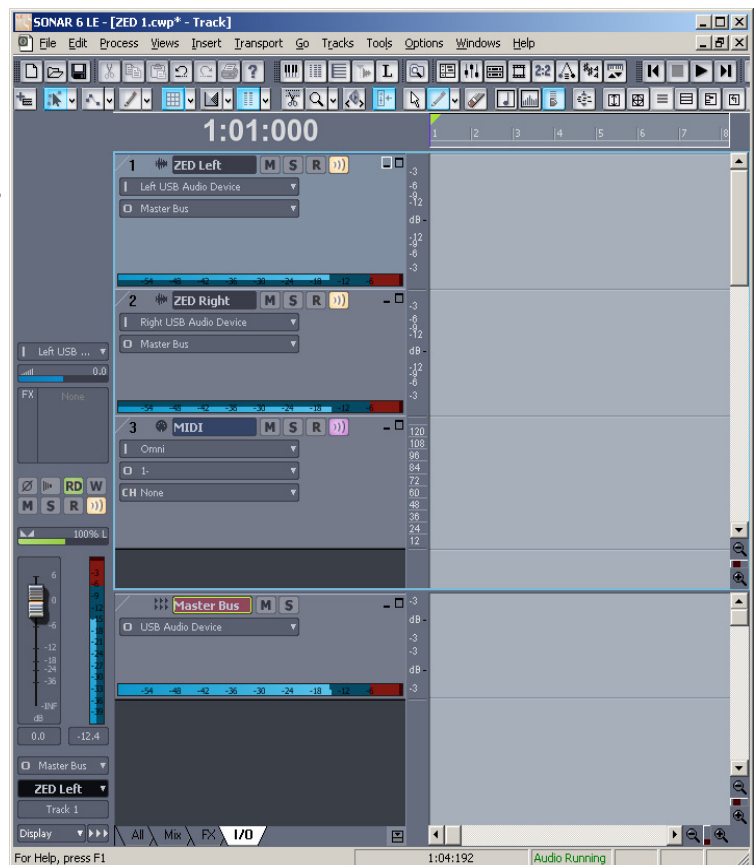

You should now be able to send audio to and from your ZED mixing console using SONAR LE.

To test this, let's do a recording...

To record the audio on tracks 1 & 2, click the R buttons so they light up red, then the record button (circle) on the transport controls on the top icon toolbar. (Or select larger transport controls from Views). The audio wave profile will show in the track panes. Click stop (Square) when finished.

To listen to the recording, click rewind, then de-select the input echo buttons (to the right of the R buttons). Also disarm the tracks by de-selecting the R buttons.

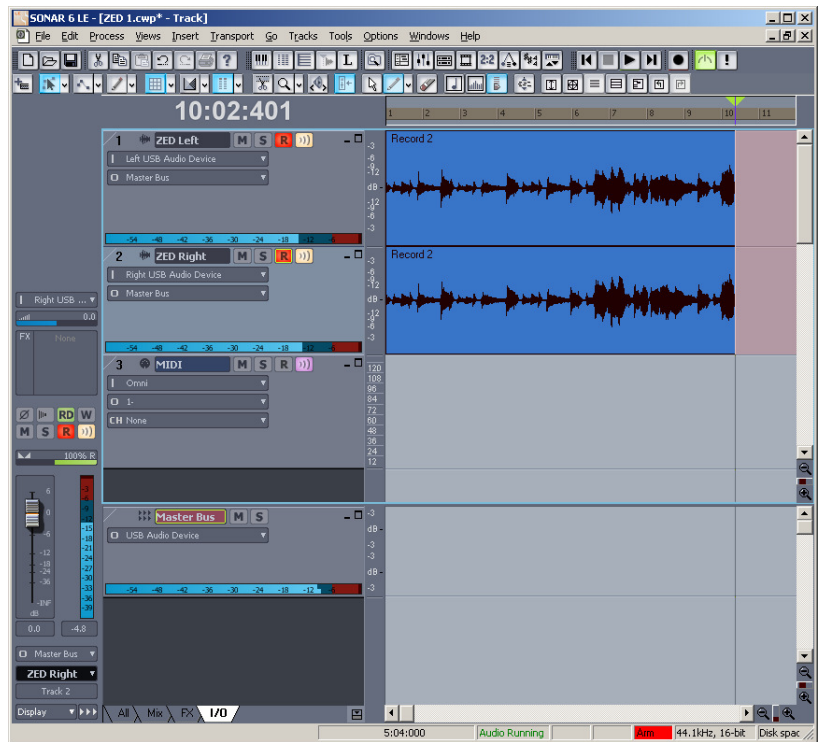

Click Play (or spacebar) and the recorded audio should play to the USB port on your ZED mixing console where you can either monitor it, route it to the main stereo bus, or route it to stereo channel 11-12.

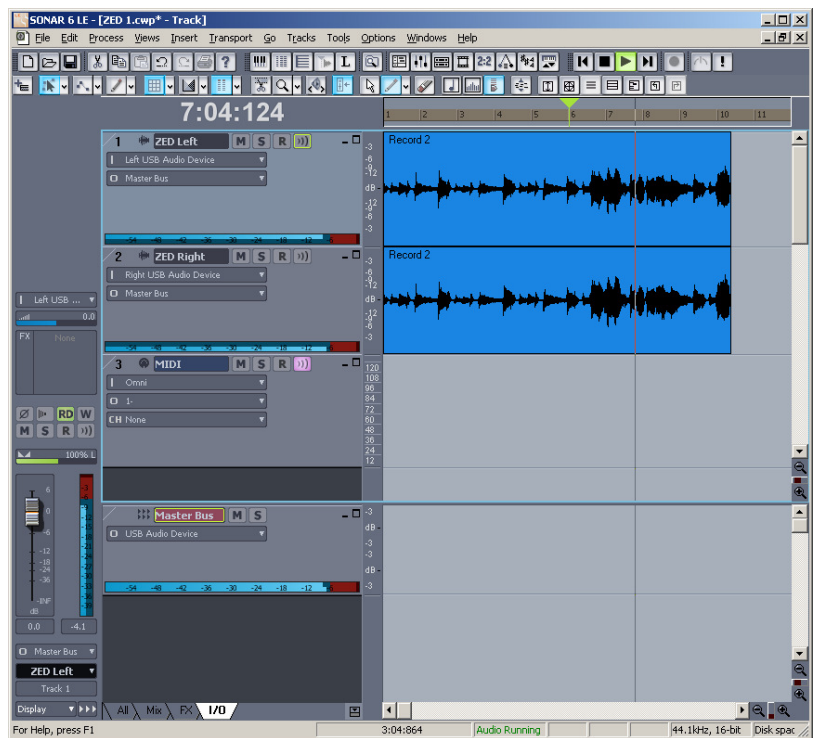

You can use SONAR LE and your ZED mixer together in many ways, for example straightforward recording of a stereo mix, recording tracks individually to build up a song, or sending a postfade mix from ZED and inserting an effects plug-in from SONAR LE, returning the post-effects signal to the mix in ZED.

It is a very versatile combination and we hope you find it a creative and enjoyable product partnership.

LIVE SETUP

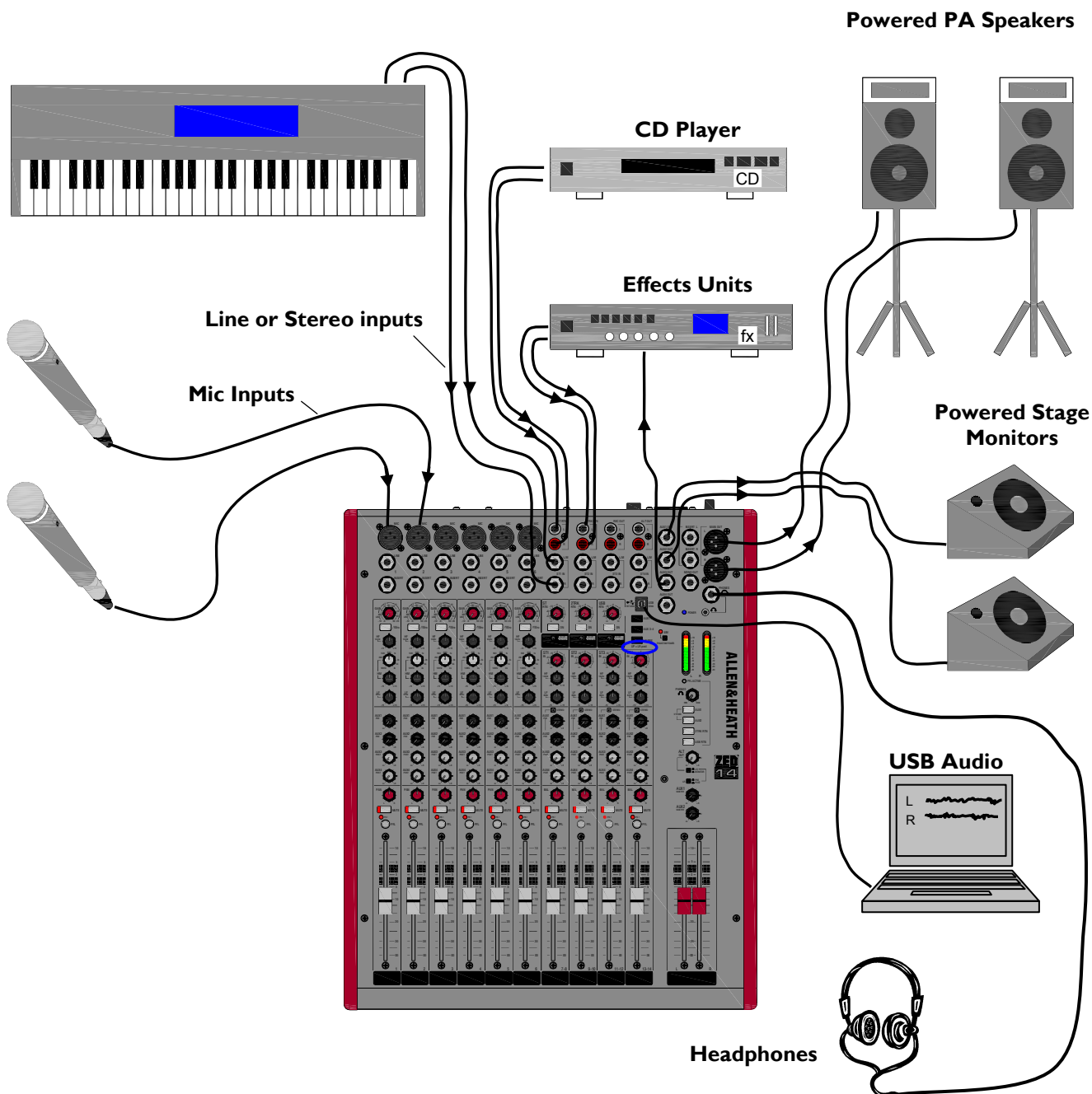

Live Sound setup notes:

1. If external compressors or noise gates are required on the mic inputs, plug them in to the channel inserts.
2. The Effects sends are from the post-fade Auxes 3 & 4. Effects returns can go to either a stereo channel or directly to L R via ST RTN, or 2 TRK if the stereo channels are used for instruments.
3. The USB audio connection to a computer can be used for recording, playback, or adding effects using a software sequencer or music software. See page 23 about using USB for effects for more details.
4. The amplifiers for the stage monitors are fed with the signals from Aux 1 & 2 for pre-fade monitor mix. This is muted when the channel Mute is pressed (between sets or changing microphones).
5. The headphones can monitor the main L R mix, the Auxes 1 & 2 (to check the stage monitor signals), the 2 TRK RTN (for checking interval music before it is fed to the speakers) or the USB audio input. The PFL signal overrides any of these if a PFL switch is pressed.

RECORDING SETUP

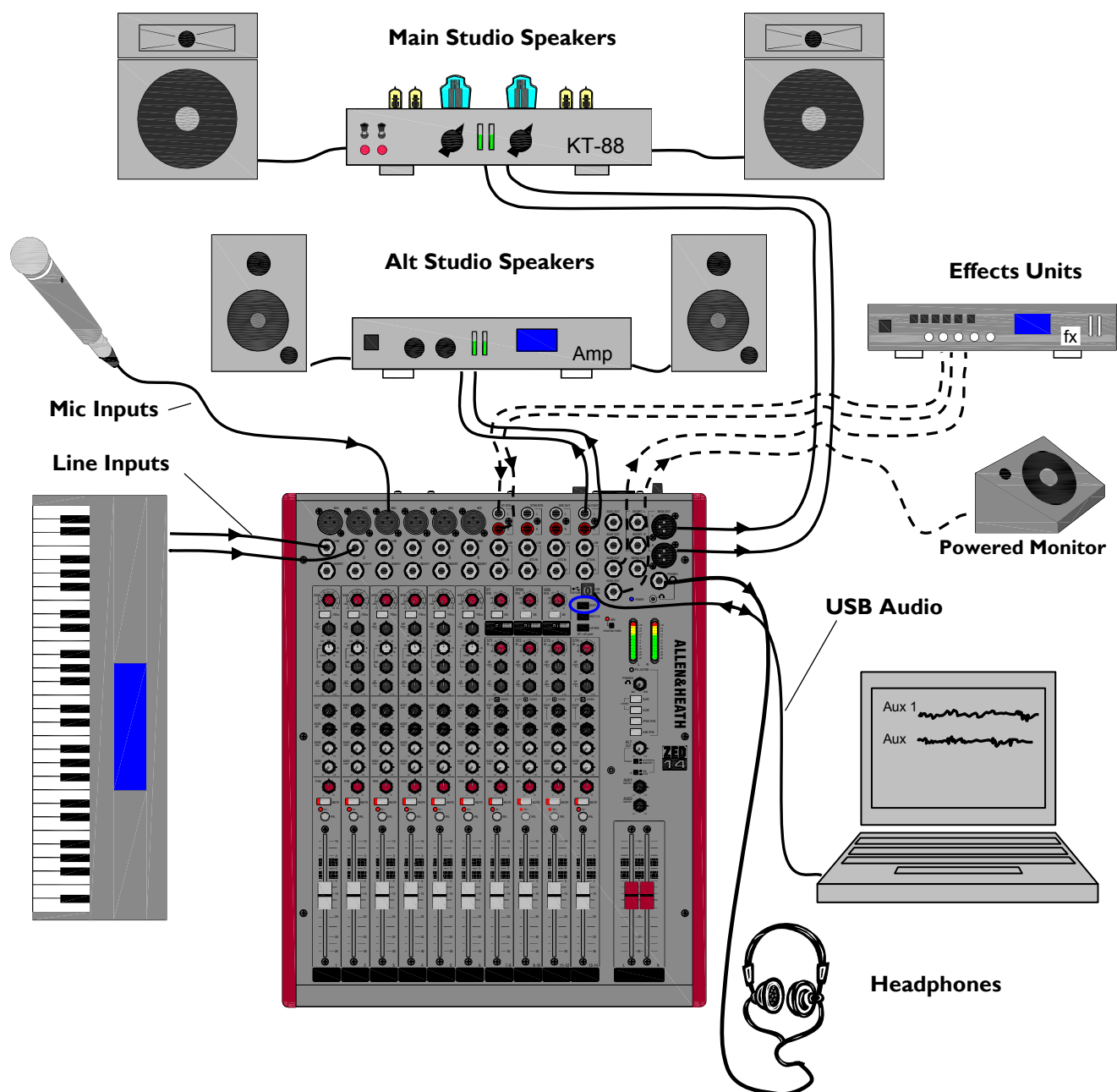

Recording setup notes:

1. A studio type recording setup can use either the USB audio interface for recording to and playback from a computer or the REC OUT and 2 TRK IN sockets for recording to and playback from analogue format machines.
2. Optimum level record sends can be set up using the Auxes 1 & 2 which are pre-fade and therefore independent of the mix fader levels. Just turn up the send on the channel you want to record from and press Aux 1-2 on the USB output selector if using a computer.
3. The song can be built up track by track using Auxes 1 & 2 to record the required channels, whilst mixing or monitoring using the faders which will not affect the recording level.
4. PFL & engineers monitoring can be connected to the ALT outputs.
5. The main L R outputs can be used to listen to the track via the USB return channel, or they can be used for direct monitoring of the channels for latency-free foldback monitoring.
6. If additional external effects are required, use the Aux 3 or 4 outputs.
7. If Auxes 3 & 4 are not used for effects, they could be used for post fade (in place) studio monitoring for the performer. Turn up the sends on the channels you want in the foldback mix, just remember that they will be affected by the channel fader.

USING USB FOR EFFECTS

The image is a composite of three parts: a hardware mixer console on the left, a software interface on the right, and a laptop below the software. The mixer console features various inputs (ST2 IN, ST3 IN, ST4 IN), USB ports (RTN, SEND), and auxiliary outputs (AUX1-2, AUX3-4, LR PRE, LR POST). The software interface shows a track with a send bus, an effect processor, and a USB device selection menu. The laptop is shown from a top-down perspective.

- 1 Use post fade Aux 3 & 4 as the sends from ZED so when you move the channel fader the effects level stays in proportion.
- 2 Select Aux 3-4 on the USB output selector switches.
- 3 USB lead carries the digital signals to & from the computer.
- 4 Select USB Device Left for Aux 3 or Right for Aux 4 as the input for the track in the software package.
- 5 You can use a send bus in software as you would a hardware mixer.
- 6 Assign an effect from your software plug in list.
- 7 If using reverb, it's a good idea to have 100% wet mix level and reduce the pre-delay in order to compensate for any latency in USB.
- 8 Send the output of the software group or bus to USB Device. In this case, and probably with most reverbs, it will be stereo so it will go to left & right.
- 9 Set the return level and select USB ON. You can monitor the level quickly by selecting USB RTN on the headphone monitor selection.
- 10 You can select the USB return to use the stereo channel 11-12. Or, if using the stereo channel for another input route the USB return direct to L-R by leaving this switch up.
- 11 If you are using the stereo channel 11-12 for the USB return signal, then this will be your effects return (Wet mix) fader for the effects to L-R.
- 12 You can then add some reverb for example, to your foldback (artists') monitors to make them sound great.

WIRING NOTES

Insert cable wiring

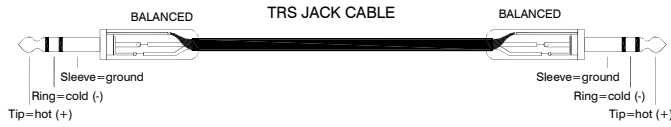
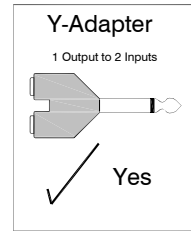
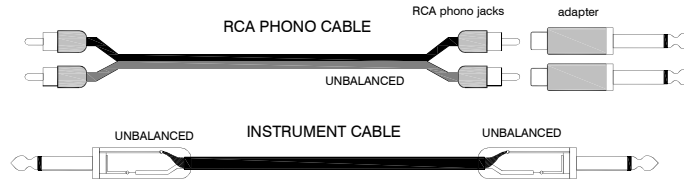
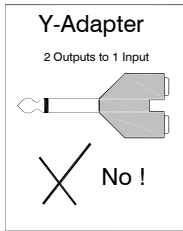
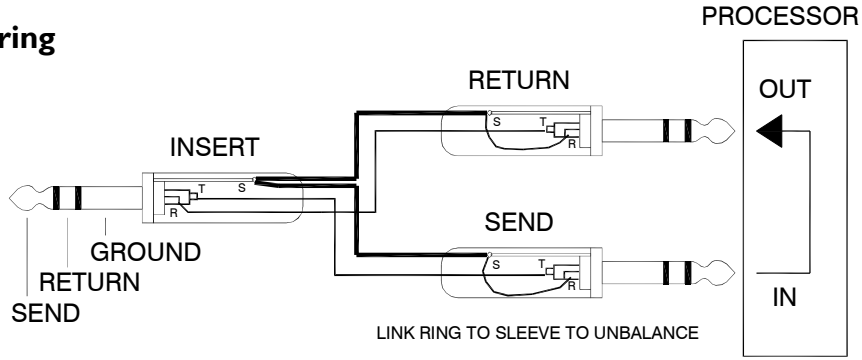

TO INPUT

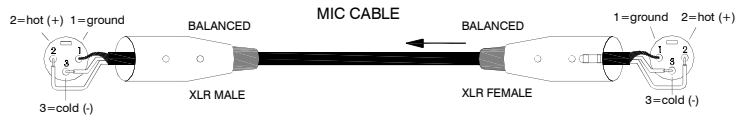

FROM OUTPUT

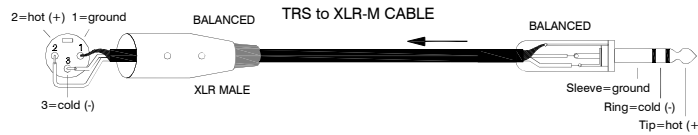
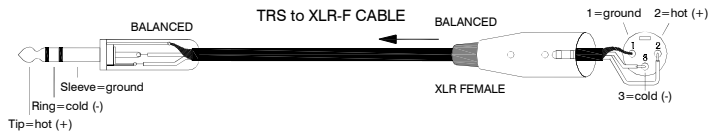

General Wiring Information

PRODUCT SUPPORT

Investigate ALLEN & HEATH's other ranges at www.allen-heath.com



Large Live Sound mixers — iLive digital, ML and GL Series

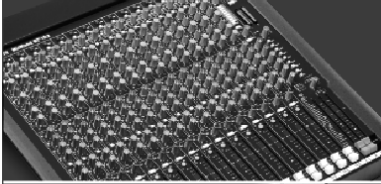

Small Format Live Sound mixers — ZED, MixWizards and PA Series



DJ products — Xone Series



Sound Management Series — iDR Series

Registering your product

Thank you for buying the Allen & Heath ZED-14 mixer. We hope that you are happy with it and that you enjoy many years of faithful service with it.

Please go to www.allen-heath.com/register.asp and register your product's serial number and your details. By registering with us and becoming an official Registered User, you will ensure that any warranty claim you might make is actioned quickly and with the minimum delay.

Alternatively, you may either copy or cut off this section of the page, fill in the details, and return it by mail to:

Allen & Heath Ltd, Kernick Industrial Estate, Penryn, Cornwall TR10 9LU, UK



ALLEN & HEATH PRODUCT REGISTRATION

Thank you for buying an Allen & Heath product. We hope that you're happy with it and that you enjoy many years of faithful service with it.

SERIAL NUMBER

Please return this section of the card by mail and retain the other part for your records. You can also register online at www.allen-heath.com. Thanks for your help.

Your Name: _____

Company Name: _____

Address 1: _____

Address 2: _____

Town/City: _____ County/State: _____

Country: _____ Postcode/Zip: _____

Telephone: _____

Email: _____

Why did you choose this console? _____

Which other products did you consider before choosing A&H? _____

Is there any thing you would like to improve on this mixer? _____

What audio magazines do you read? _____

If you were going to design a mixer for your work, what are the 6 most important features it should have (in order of importance)

1	2
3	4
5	6

We may use the information you provide to inform you of future product developments. We will not give or sell this data to third parties. Please indicate with an 'x' if you do not wish to receive any further communications from us.

