

# NX 985-A

## PROFESSIONAL THREE-WAY ACTIVE SPEAKER

### DESCRIPTION

NX 985-A is a three-way active speaker masterfully engineered from the ground up to deliver stellar audio performance for Bands, DJs, Clubs, and Rental Companies. The best-in-class combination of RCF premium transducers and a two-channel 2100W amplifier produce coherent 100° x 60° coverage for the listening area with up to 138 dB SPL of distortion-free sound. The three-way design features a 1.75" neodymium compression driver with a constant directivity waveguide, 8" cone midrange on a phase-coherent waveguide, and a 15" high power woofer. Used as a stand-alone speaker, flown, coupled with another NX 985-A or combined with the RCF SUB 8008-AS subwoofer, the NX 985-A delivers extreme SPL output at all frequencies with high performance and reliability. The rugged, tour-ready, high-quality all-plywood cabinet is easy to carry and secure to install using the dedicated rigging points available.



### FEATURES

- Up to 138 dB Sound Pressure Level
- 2100W Class-D Amplifier
- 40-20000 Hz linear frequency response
- 1.75" Neodymium Compression Driver with Peek diaphragm
- 8" Midrange, 2.5" v.c.
- 15" High Power Woofer
- Bass Motion Control and FIRPHASE processing
- M10 Rigging Points
- IP Rated Powercon TRUE1 TOP IN/OUT

## TECHNICAL SPECIFICATIONS

<b>Acoustical specifications</b>	Frequency Response:	40 Hz ÷ 20000 Hz
	Max SPL @ 1m:	138 dB
	Horizontal coverage angle:	100°
	Vertical coverage angle:	60°
<b>Transducers</b>	Compression Driver:	1 x 1.0" neo, 1.75" v.c
	Midrange:	8" neo, 2.5" v.c
	Woofers:	15", 3.0" v.c
<b>Input/Output section</b>	Input signal:	bal/unbal
	Input connectors:	Combo XLR/Jack
	Output connectors:	XLR
	Input sensitivity:	-2 dBu/+4 dBu
<b>Processor section</b>	Crossover Frequencies:	Bass/Mid:320Hz, Mid/High:1200Hz
	Protections:	Thermal, Excurs., RMS
	Limiter:	Soft Limiter
	Controls:	Linear, 2 Speakers, High Pass, Volume
<b>Power section</b>	Total Power:	2100 W Peak
	High frequencies:	200 W Peak
	Mid frequencies:	500 W Peak
	Low frequencies:	1400 W Peak
	Cooling:	Convection
	Connections:	Powercon TRUE1 TOP IN/OUT
<b>Standard compliance</b>	CE marking:	Yes
<b>Physical specifications</b>	Cabinet/Case Material:	Plywood
	Hardware:	3 x M10 Top, 1 x M10 each side, 1 x M10 bottom, 2 x M10 rear
	Handles:	1 x Side
	Grille:	Steel
	Color:	Black
<b>Size</b>	Height:	1075 mm / 42.32 inches
	Width:	461 mm / 18.15 inches
	Depth:	475 mm / 18.7 inches
	Weight:	45 kg / 99.21 lbs
<b>Shipping informations</b>	Package Height:	530 mm / 20.87 inches
	Package Width:	1110 mm / 43.7 inches
	Package Depth:	490 mm / 19.29 inches
	Package Weight:	51 kg / 112.44 lbs



**PART NUMBER**

• **13000757**

NX 985-A

100-120V

EAN 8024530020064

• **13000743**

NX 985-A

220-240V

EAN 8024530019914

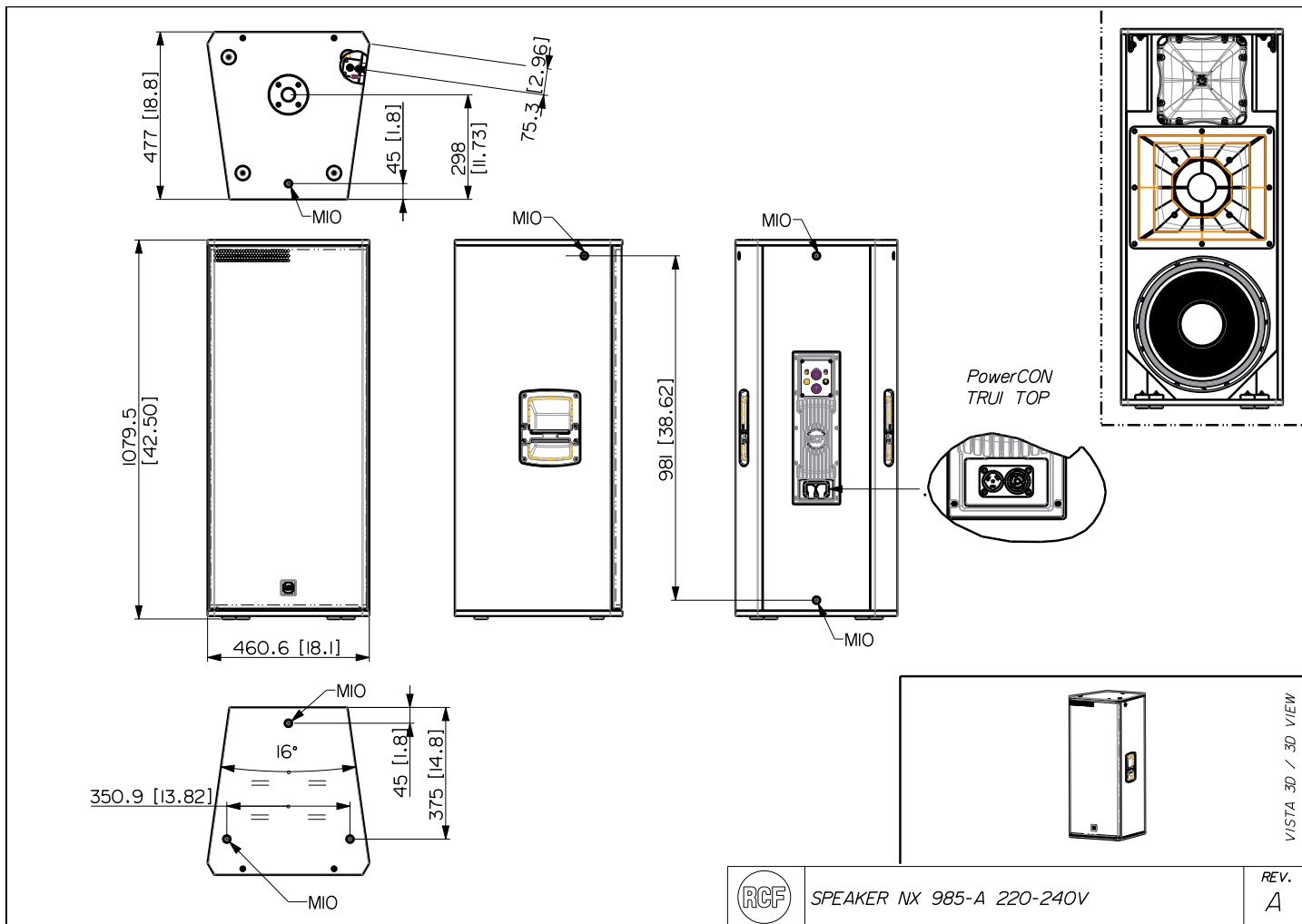

SPEAKER NX 985-A 220-240V

REV.  
A

VISTA 3D / 3D VIEW

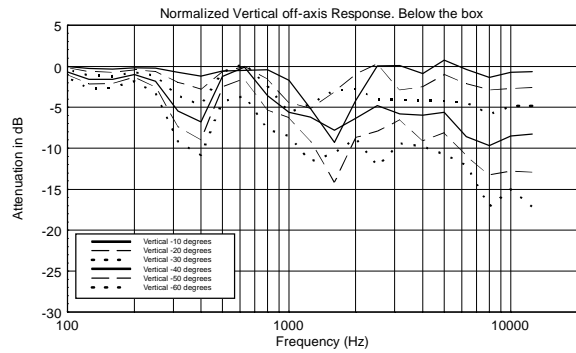
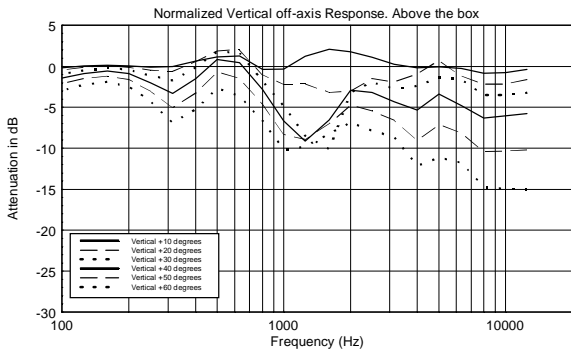
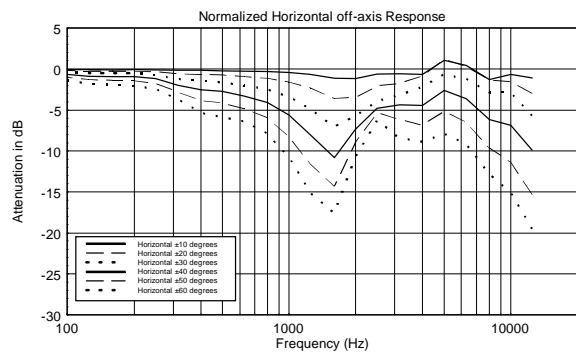
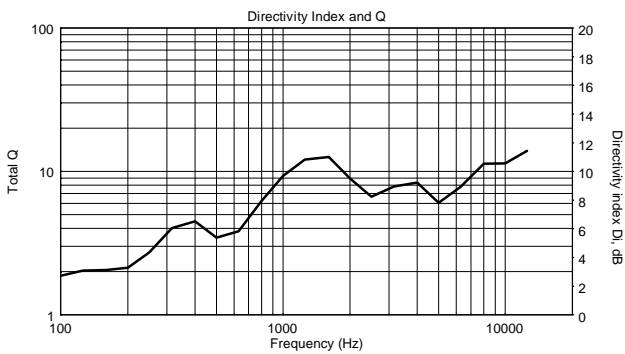
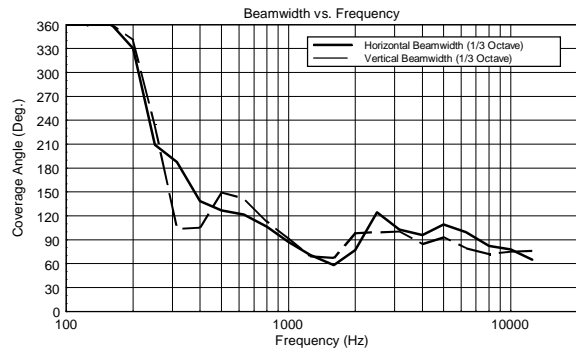
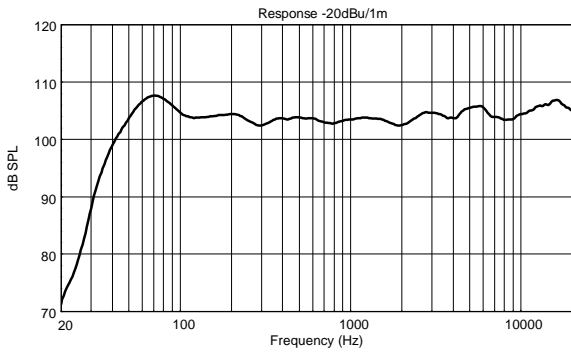

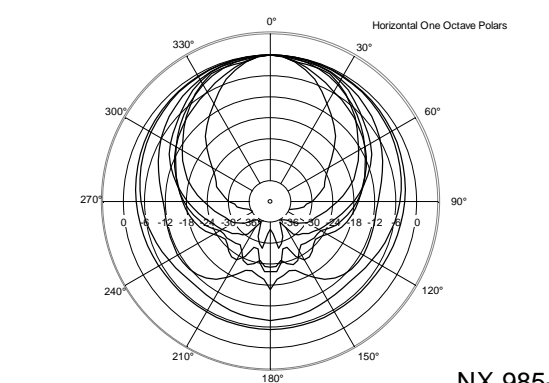
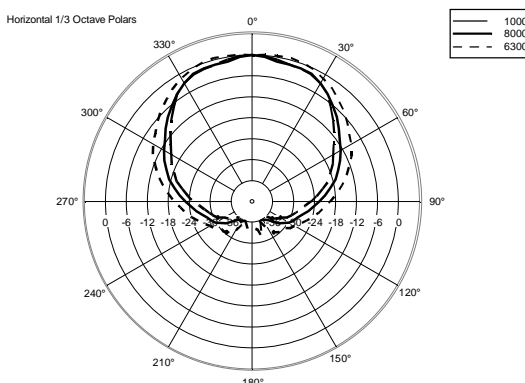
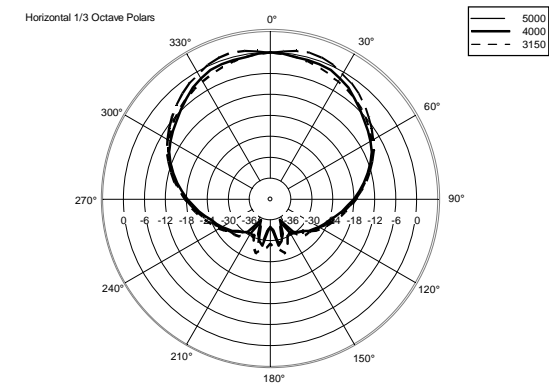
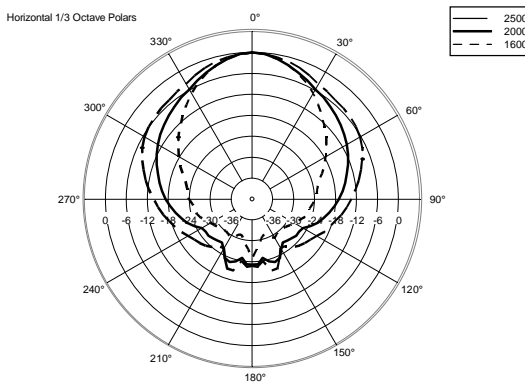
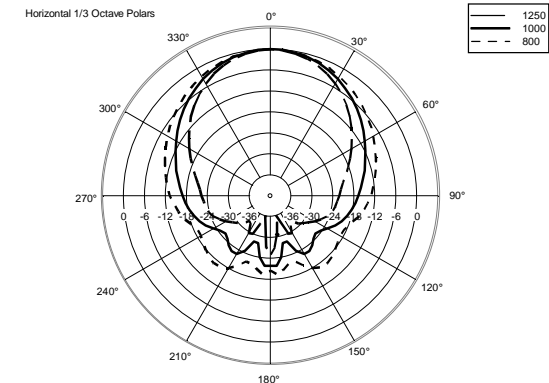
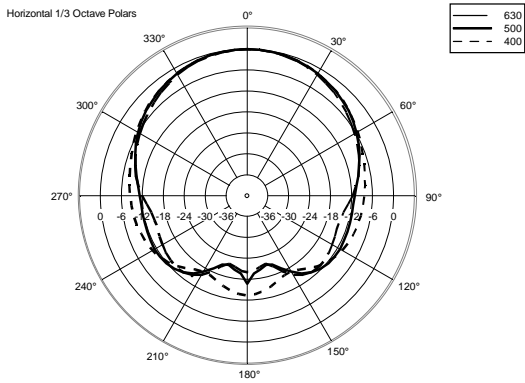
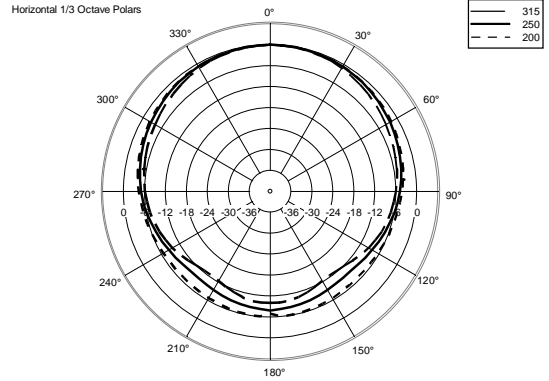
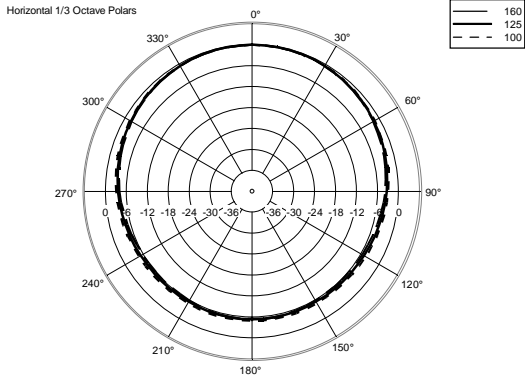

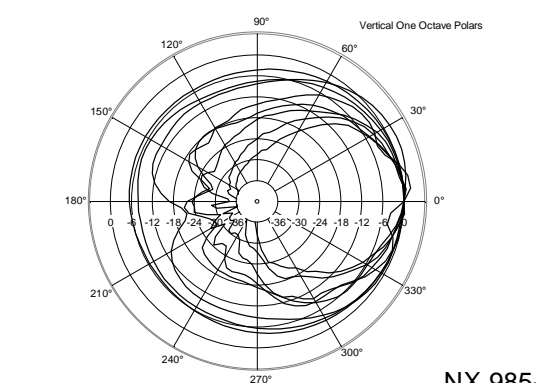
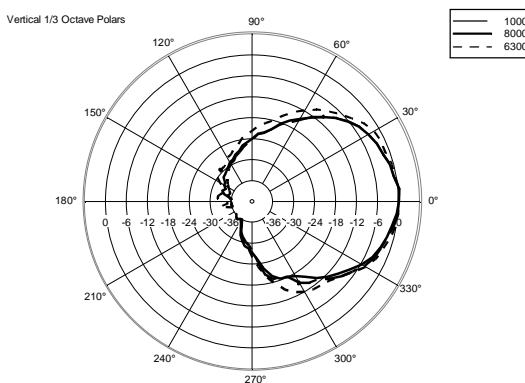
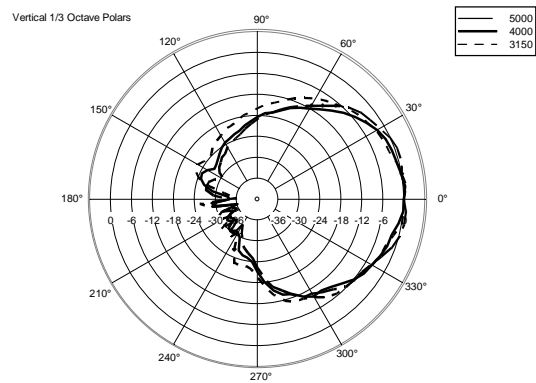
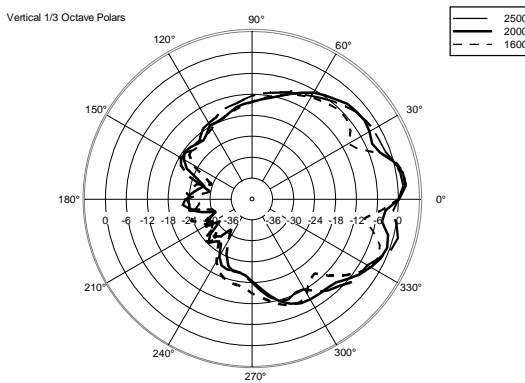
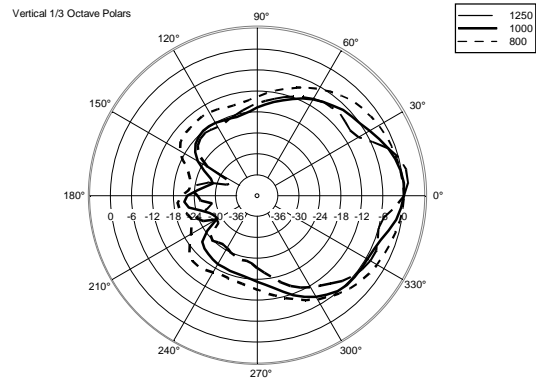
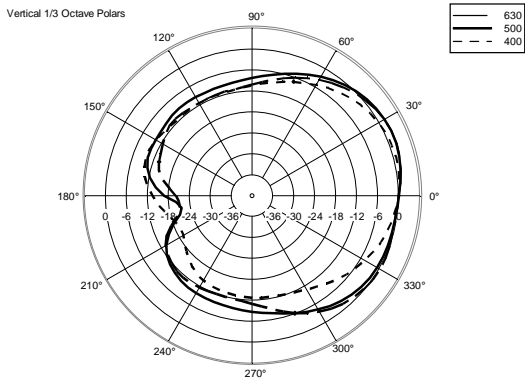
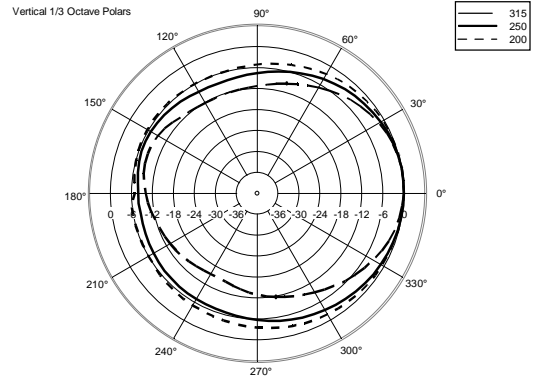
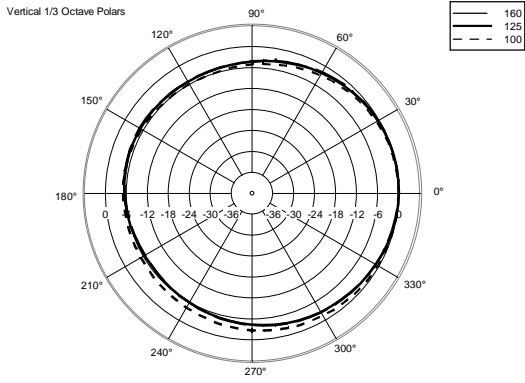

**ACCESSORIES**

AC PMA - POLE MOUNT

PART NUMBER **13360034**  
EAN: 8024530007713

AC PMX POLE MOUNT M20

PART NUMBER **13360232**  
EAN: 8024530010058

AC PRO-FS PROFESS. LOCKING FLOOR STAND

PART NUMBER **13360109**  
EAN: 8024530006471