

# COMPACT A 10

## TWO-WAY PROFESSIONAL SPEAKER

### DESCRIPTION

COMPACT A 10 is a multipurpose two-way full-range professional speaker system, suitable for a wide range of applications, such as live sound reinforcement and stage monitoring as well as distributed sound systems for clubs or music venues. The combination of a 1.75" compression driver, 10" woofer, and the constant directivity True Resistive Waveguide produces coherent 100° x 60° coverage for the listening area with up to high SPL, distortion-free sound. The sleek and lightweight cabinet uses a special polypropylene composite material with an M-brace internal reinforcement, making it easy to carry and secure to install on a pole, flown-, wall-, or truss-mounted using the multiple rigging points and available accessories.



### FEATURES

- 350 W power handling
- Up to 128 dB Sound Pressure Level
- 60-20000 Hz linear frequency response
- 1.75" Compression Driver
- 10" High Power Woofer
- Robust composite material cabinet
- Steel full front grille
- Optional mounting accessories
- 2 x SPEAKON connectors

## TECHNICAL SPECIFICATIONS

<b>Acoustical specifications</b>	Frequency Response (-10dB):	60 Hz ÷ 20000 Hz
	Max SPL @ 1m:	128 dB
	Horizontal coverage angle:	100°
	Vertical coverage angle:	60°
	System Sensitivity:	97 dB
<b>Power section</b>	Amplification:	Full Range
	Nominal Impedance:	8 ohm
	Power Handling:	350 W
	Peak Power Handling:	1400 W PEAK
	Recommended Amplifier:	700 W
	Protections:	Dynamic Active Mosfet
	Crossover Frequencies:	1400 Hz
<b>Transducers</b>	Compression Driver:	1.0", 1.75" v.c
	Woofers:	10", 2.5" v.c
<b>Input/Output section</b>	Input connectors:	Speakon
	Output connectors:	Speakon
<b>Physical specifications</b>	Cabinet/Case Material:	PP Composite
	Hardware:	1 x M10 top and bottom
	Handles:	1 top
	Pole mount/Cap:	Yes
	Grille:	Steel
	Color:	Black
<b>Size</b>	Height:	572.1 mm / 22.52 inches
	Width:	329.9 mm / 12.99 inches
	Depth:	310 mm / 12.2 inches
	Weight:	16.2 kg / 35.71 lbs
<b>Shipping informations</b>	Package Height:	616 mm / 24.25 inches
	Package Width:	370 mm / 14.57 inches
	Package Depth:	390 mm / 15.35 inches
	Package Weight:	18.2 kg / 40.12 lbs

## PART NUMBER

- **13000738**

COMPACT A 10

EAN 8024530019747

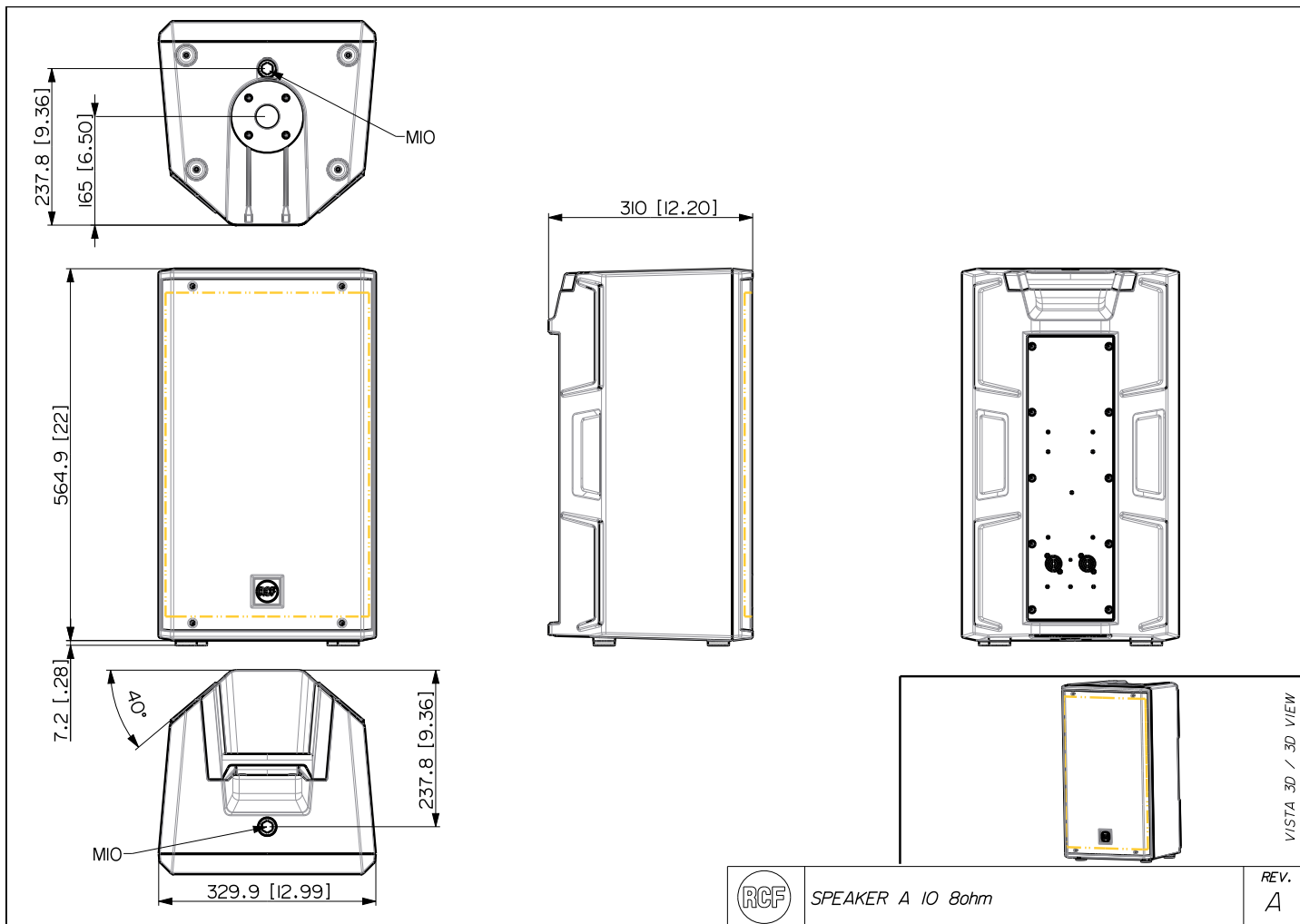

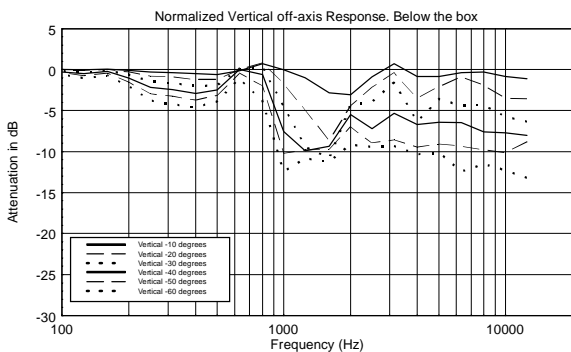
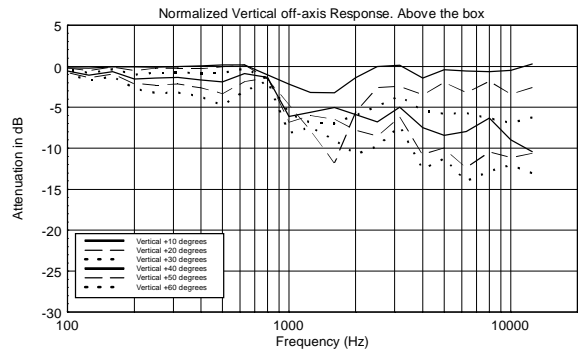
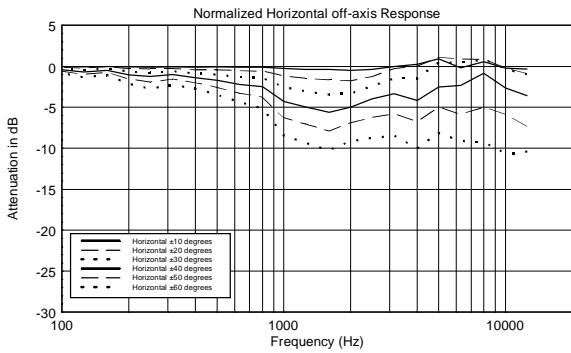
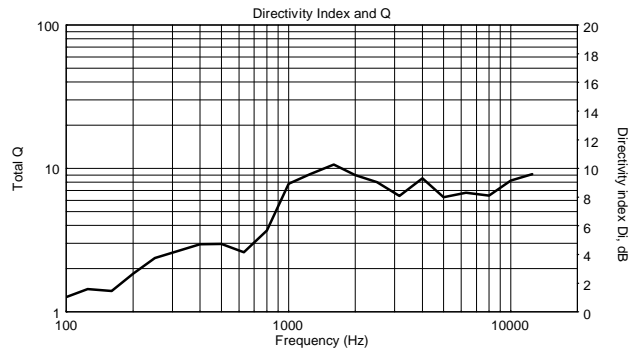
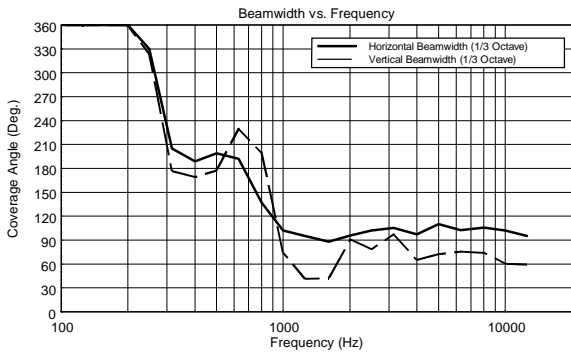
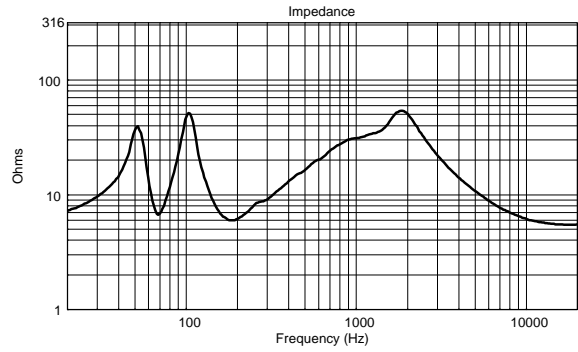
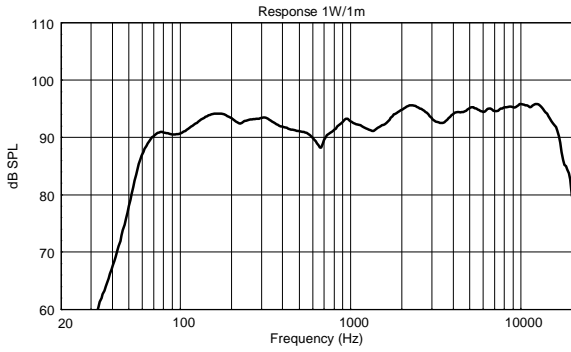

Horizontal 1/3 Octave Polars

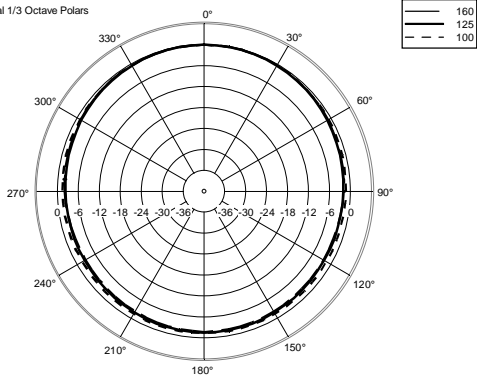

Horizontal 1/3 Octave Polars

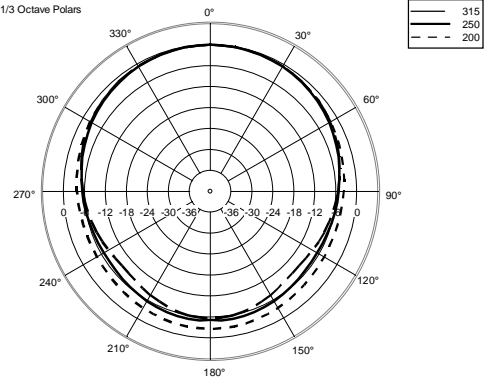

Horizontal 1/3 Octave Polars

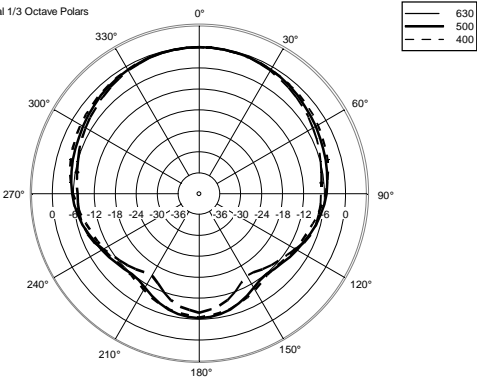

Horizontal 1/3 Octave Polars

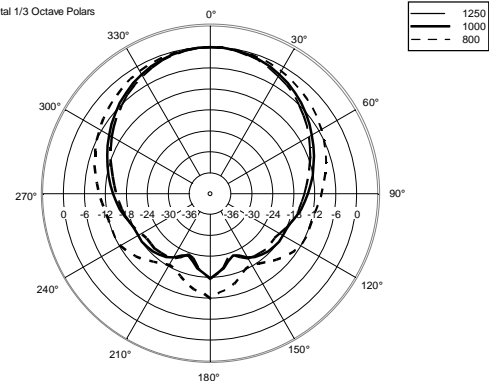

Horizontal 1/3 Octave Polars

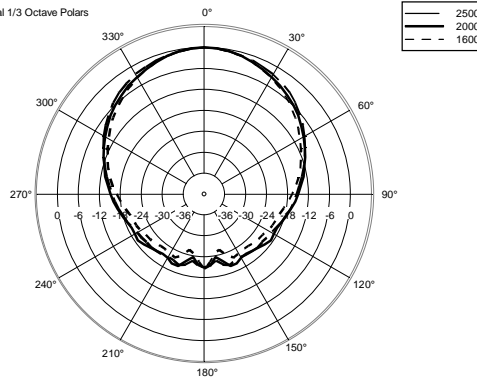

Horizontal 1/3 Octave Polars

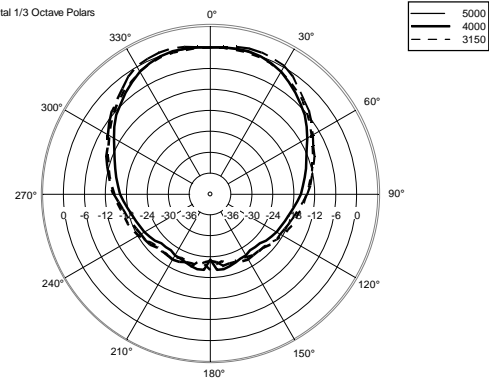

Horizontal 1/3 Octave Polars

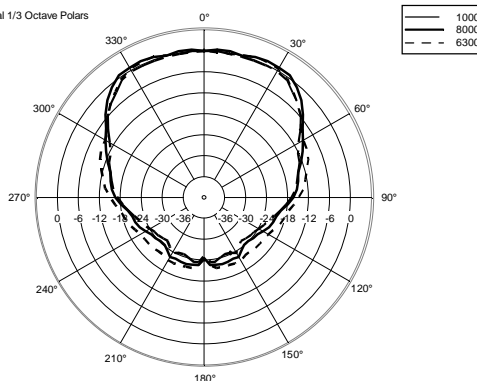

Horizontal One Octave Polars

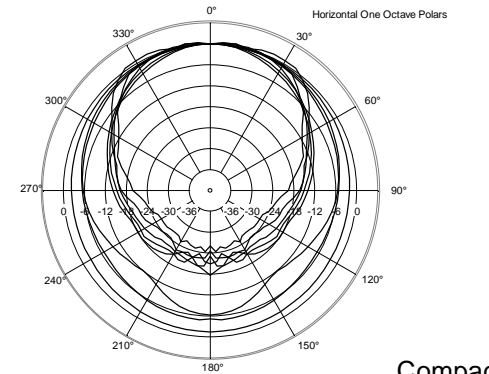

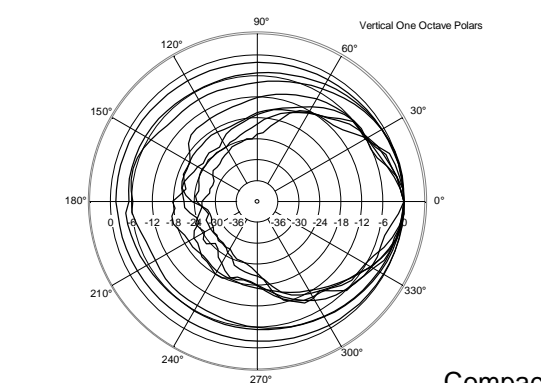
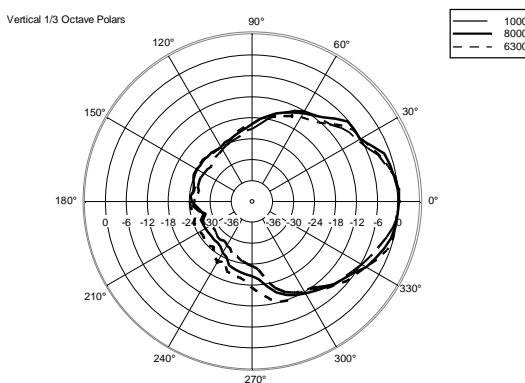
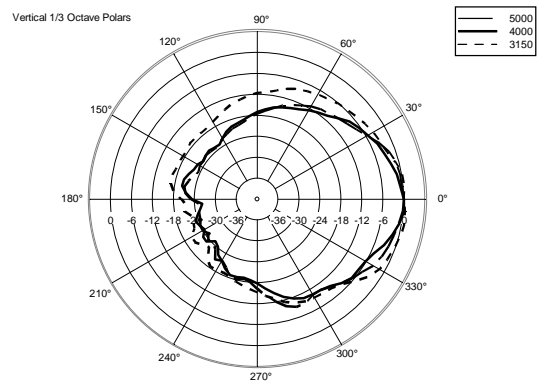
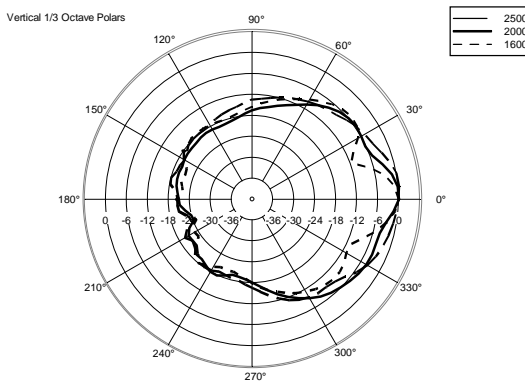
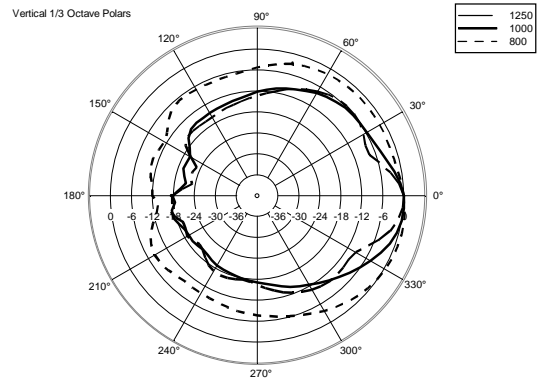
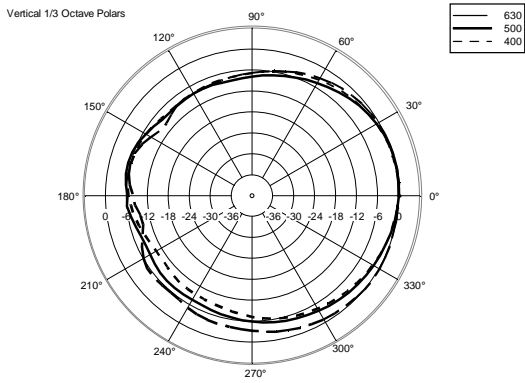
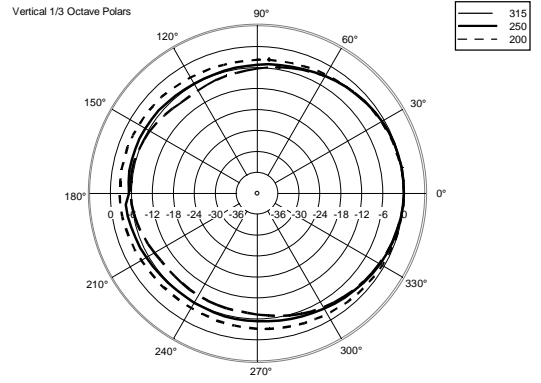
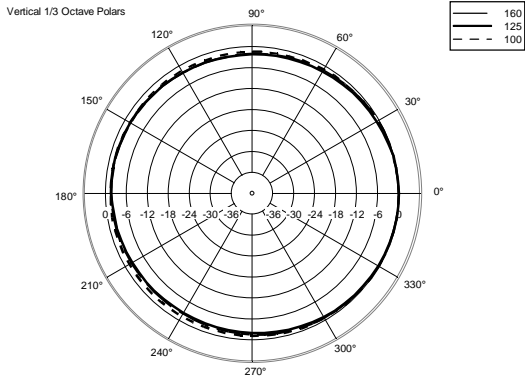

**ACCESSORIES**

AC PM-M20

PART NUMBER **13360067**  
EAN: 8024530014599

AC PMX POLE MOUNT M20

PART NUMBER **13360232**  
EAN: 8024530010058

AC PRO-FS PROFESS. LOCKING FLOOR STAND

PART NUMBER **13360109**  
EAN: 8024530006471

AC PRO-PM PROFESS. LOCKING POLE MOUNT

PART NUMBER **13360110**  
EAN: 8024530006488

COVER CVR ART 910

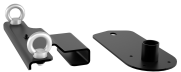
PART NUMBER **13360473**  
EAN: 8024530018832

FLYING BRACKET FL-BR ART 910

PART NUMBER **13360472**  
EAN: 8024530019235

HORIZONTAL BRACKET H-BR ART 910

PART NUMBER **13360471**  
EAN: 8024530019242



## **A&E SPECIFICATIONS**

The product shall be a multipurpose two-way full-range professional speaker system, suitable for a wide range of applications, such as live sound reinforcement and stage monitoring as well as distributed sound systems for clubs or music venues. It shall feature high sensitivity, typical of professional audio cabinets, with smooth and wide frequency response, thanks to the wave-guided compression driver. It shall be robust, suitable for transportation and for any working environment. Optional mounting accessories shall be available for wall or ceiling installations.