

# M 20X Digital Mixer - User's Manual

---



Date: 24 Oct 2019  
Rev.: 1.0.

This document refers to Firmware version 152  
p/n:

M 20 series products offer all-in-one mixing, processing and routing capabilities, including a comprehensive set of recording and playback functions. The User Interface has been designed so that every parameter is reachable within few operations. All models are equipped with 20 analog inputs (16 of which are with remote controlled preamps) and 14 output channels, between the balanced analog outputs and the AES/EBU digital output.

M 20 series digital mixing consoles are based on floating-point DSP (digital signal processors), running at a sample rate of 48 kHz, ensuring maximum audio quality and low noise floor, an essential requirement for modern audio applications.

## Sommario

1. Overview.....	3
Hardware Description.....	3
System Overview .....	7
2. FIRMWARE UPDATE.....	8
FIRMWARE UPDATE PROCEDURE.....	8
3. BACKUP & RESTORE.....	10
BACKUP FUNCTION PROCEDURE.....	10
RESTORE FUNCTION PROCEDURE.....	11
4. PROCESSING .....	13
INPUT PROCESSING.....	13
CHANNEL SECTION.....	14
GATE SECTION.....	16
PARAMETRIC EQ.....	17
DYNAMICS – Compressor/DeEsser .....	19
SENDS.....	21
OUTPUT PROCESSING .....	23
CHANNEL VIEW.....	24
8-Band PARAMETRIC EQ.....	25
DYNAMICS – Master Compressor/Limiter .....	27
30-Band GRAPHIC EQ.....	28
EFFECTS.....	29
REVERB .....	30
DELAY .....	31
MODULATION .....	32
FX RETURN .....	33
MONITORING.....	34
METERS.....	34
RTA.....	34
PHONES.....	35
PLAY/REC .....	36
SETUP .....	36
PLAYER.....	37
RECORDER.....	38
5. Technical Specifications.....	40
6. Block Diagram .....	42

# 1. Overview

## Hardware Description

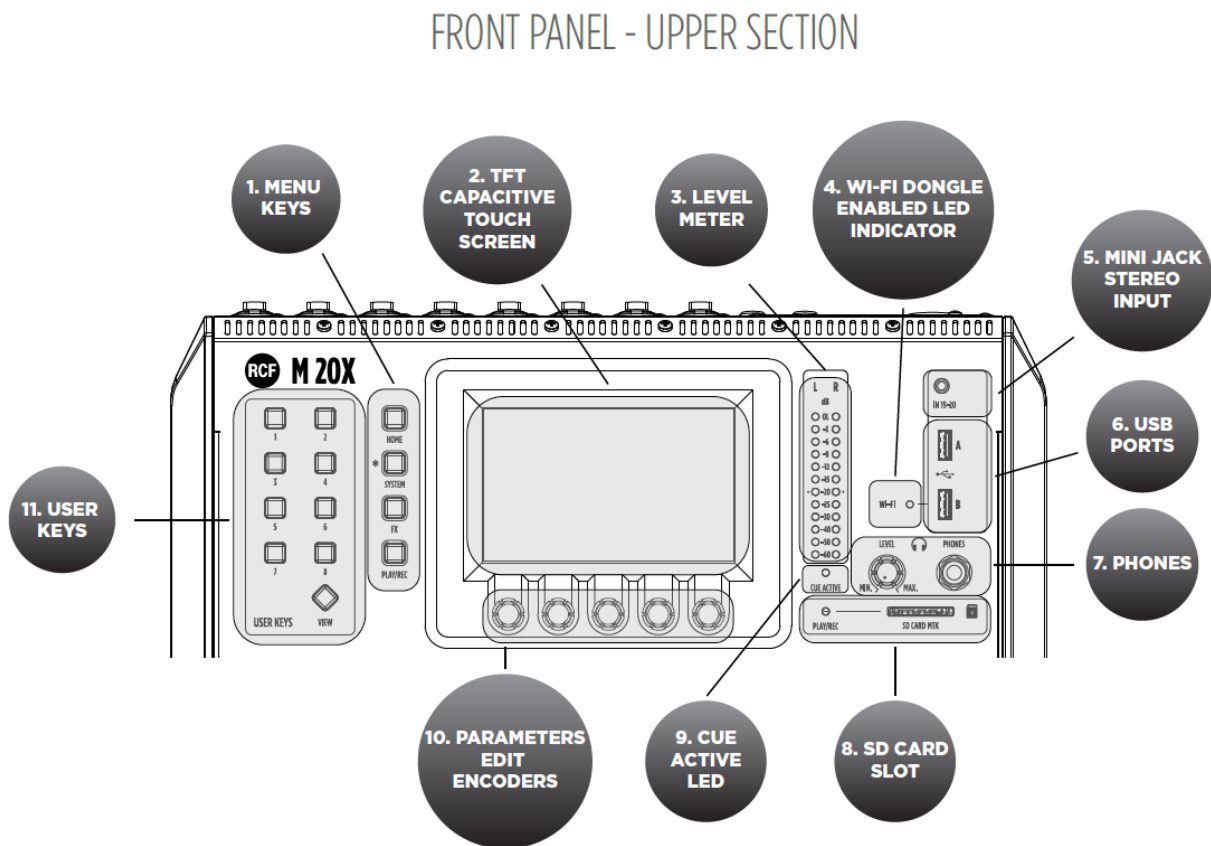

- 1. MENU KEYS**  
4 menu keys allow an intuitive and immediate navigation through menu pages.
- 2. TFT CAPACITIVE TOUCH SCREEN**  
A highly responsive 5-inch TFT touchscreen offers intuitive navigation of all the available features, and can be optionally paired with an external tablet to augment interaction with the M 20X.
- 3. LEVEL METER**  
This 12 LED elements level meter normally allows you to control the Main Mix output level. When a channel CUE button is pressed, the level meter shows the PFL level present in the selected channel. Keep the input level below the “-20” indication to avoid overloaded signals that can cause distortion.
- 4. WI-FI DONGLE ENABLED LED INDICATOR**  
This led light up when the WI-FI AP function for the USB port “B” is enabled, allowing the use of a WiFi USB dongle.
- 5. MINI JACK STEREO INPUT 19-20**  
Connect here your stereo line level sources like smartphones, laptops or others external audio devices.
- 6. USB PORTS**  
Two USB host ports on the top panel are available for WiFi dongles, USB-MIDI devices, and USB mass storage devices that can be used for stereo audio record/ playback, system backups and firmware updates.
- 7. PHONES**  
Connect your headphones here either for CUE or the Main Mix listening.

8. SD CARD SLOT  
An integrated SD card multitrack engine offers a maximum of 20 simultaneous tracks at 24-bit, 48 kHz, with extensive routing options.
9. CUE ACTIVE LED  
This led light up when one or more CUE button are pressed.
10. PARAMETERS EDIT ENCODERS  
5 dedicated encoders allow an intuitive and immediate control of each function and parameter on the screen.
11. USER KEYS  
A set of 8 User Keys with extensive programming option are always available, and offers immediate control of scene selection, play/record transport, tap tempo, user interface shortcuts. The USER KEYS functions can also be driven remotely via MIDI (through a MIDI-USB interface).

## FRONT PANEL - LOWER SECTION

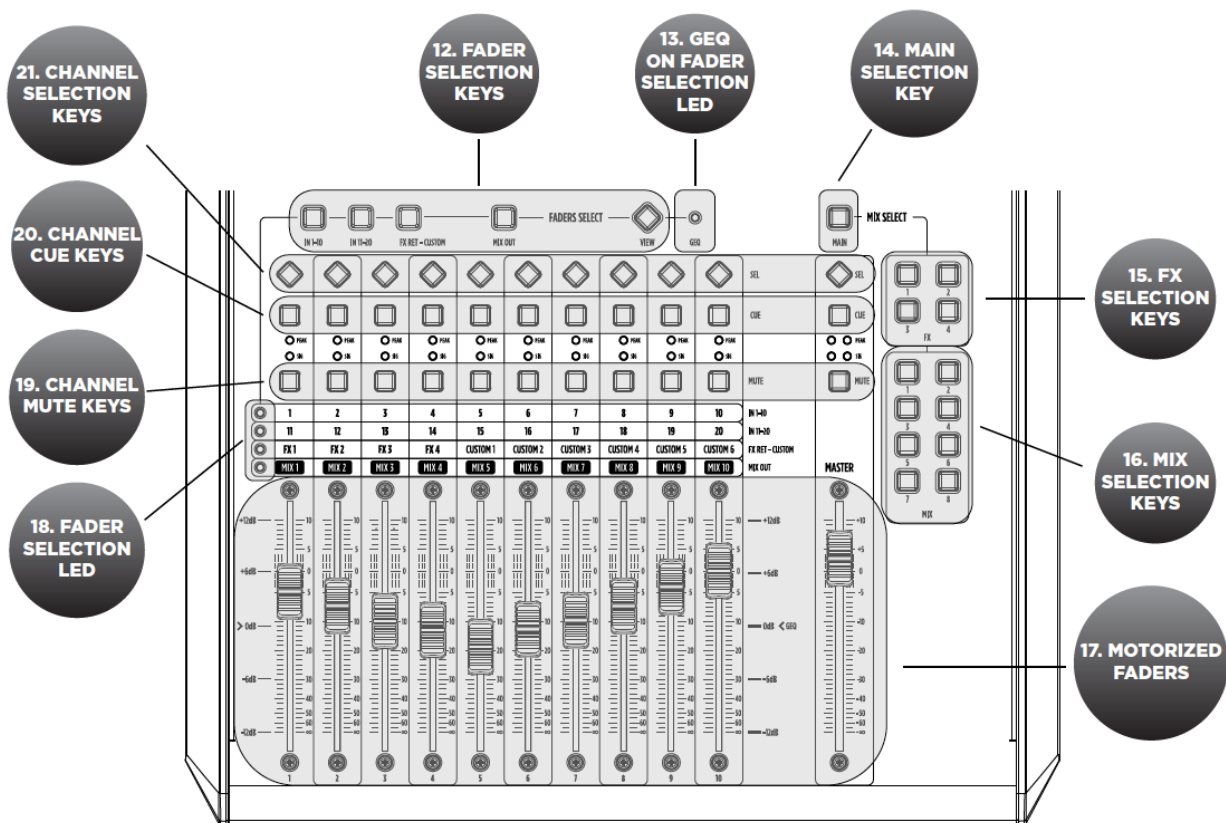

12. FADER SELECTION KEYS  
4 layers of faders assignments allow immediate access to input channels 1-10 and 11-20, to FX returns and outputs.
13. GEQ ON FADER SELECTION LED  
This LED lights up when the function Graphic EQ on Fader is enabled.
14. MAIN SELECTION KEY  
The control surface can be assigned to the stereo MAIN mix buss; the MASTER fader is always associated to the output level of the selected bus.

15. FX SELECTION KEYS

The control surface can be assigned to 4 FX busses; the MASTER fader is always associated to the output level of the selected bus.

16. MIX SELECTION KEYS

The control surface can be assigned to 8 MIX busses; the MASTER fader is always associated to the output level of the selected bus.

17. MOTORIZED FADERS

11 x 100-mm motorized faders allow precise mix control with immediate visual feedback. Special care has been taken to minimize movement noise.

18. FADER SELECTION LED

These 4 leds light to show the current assigned layer of faders.

19. CHANNEL MUTE KEYS

MUTE buttons when pressed inhibit the signal to flow to output bus or main mix paths.

20. CHANNEL CUE KEYS

The CUE keys allow to listen the signal present on the channel, through the cue bus routed to PHONES OUTPUT. All audio paths can be monitored at any time via the CUE bus, which features a real-time analyzer (RTA).

21. CHANNEL SELECTION KEYS

The SELECTION KEYS allow an intuitive and immediate navigation through channel functions and parameters.

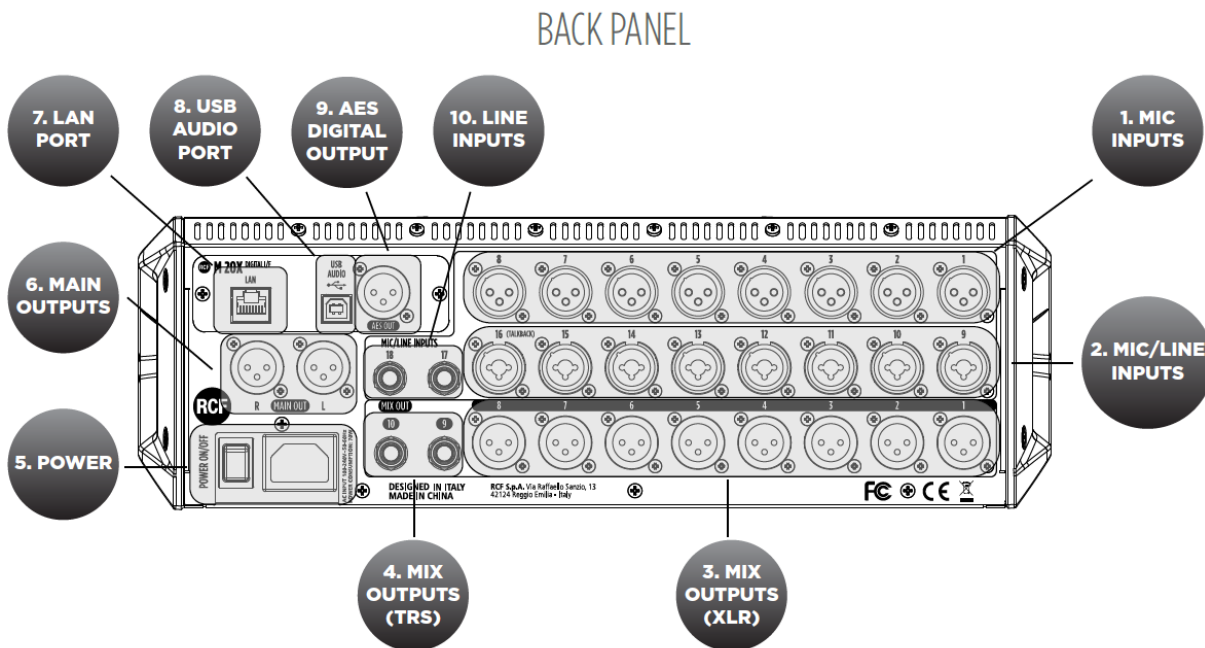

1. MIC Inputs 1-8 Female XLR

Connect your Microphones to these remotely-controlled 60dB gain-range inputs. Use balanced XLR cables to obtain best performance from your microphones.

2. MIC/LINE Inputs 9-16 Combo

Input 9 to 16 provide Mic inputs on the XLR connection and Line input on the TRS jack connection.

3. MIX Outputs 1-8 Male XLR

Connect to these +24dBu balanced XLR outputs your stage monitors or external effects.

#### 4. MIX Outputs 9-10 TRS

Connect to these +24dBu balanced TRS outputs your stage monitors or external effects.

#### 5. POWER

Use this switch to turn On and Off your M 20X device. Connect to the VDE inlet the provided power cord.

#### 6. MAIN OUTPUT

Connect your active speaker or your amplifier, in case of passive speakers, to these +24dBu balanced Output.

#### 7. LAN PORT

The mixer can be remotely controlled via LAN, and an external Wi-Fi Access Point can be connected to the LAN port to communicate with remote control apps running on iOS and Android.

#### 8. USB AUDIO PORT

A 24-track, 24-bit, 48-kHz audio interface is available and allows access to all inputs and several internal signal nodes. Extensive routing options allow both offline sound check and host-based effects processing.

#### 9. AES DIGITAL OUTPUT

Connect here any AES/EBU device. Each of the audio output paths is routable to the AES/EBU port.

#### 10. LINE INPUTS 17-18 TRS

Connect here your line level sources like keyboard, external audio device or other small analog consoles used for submix.

## System Overview

The M 20X Digital Mixer is a feature-packed unit that includes several of the useful blocks required to arrange a good-sounding live act.

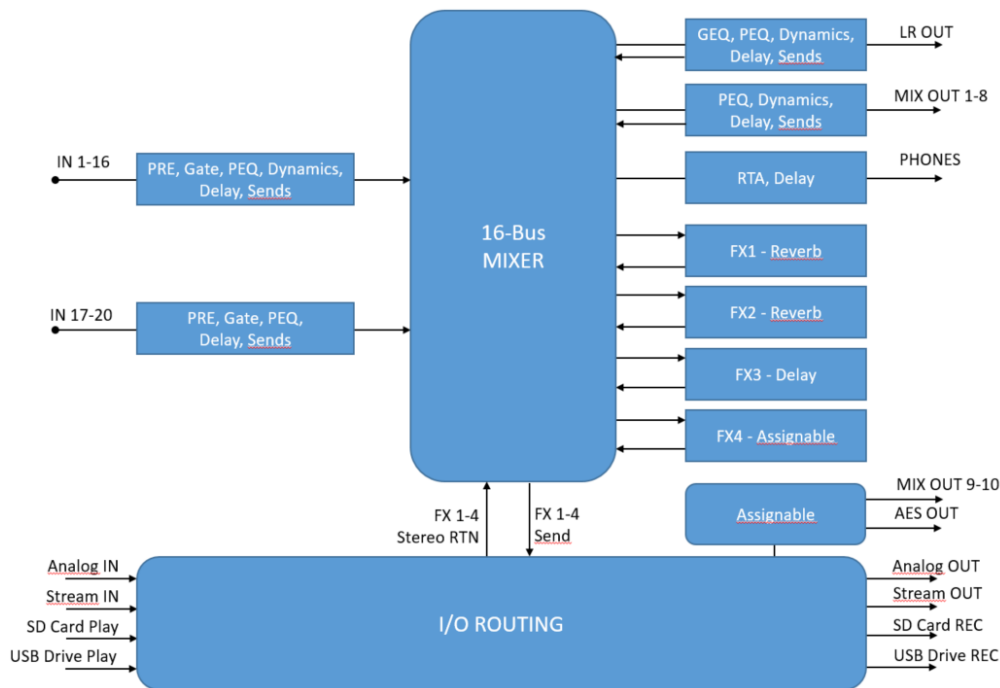

*Signal processing capabilities of the M 20X Digital Mixer*

A total of 16 summing bus are present in the M 20 Digital Mixer:

- MAIN LR bus
- FX SEND 1-4 bus
- MIX SEND 1-8 bus
- Stereo PHONES bus

Each of the 20 inputs features a 12 dB/oct HPF, a noise Gate, a Compressor/De-Esser (inputs 1-16 only), a flexible 4-band Parametric EQ, and a Delay line. The source can be selected between the analog inputs, the USB audio interface, the SD card player, into different insertion points for maximum flexibility.

M 20X boast 4 stereo FX engines available on dedicated busses, offering two high quality digital reverbs, a programmable delay and a 4th effect which can be configured as a modulation or a second delay. All FX Engines offer multiple algorithms to match the specific needs of a show.

A complete processing section is available on all outputs: a flexible 8-band Parametric EQ with several selectable modes that also allow different slopes, a Delay with up to 85 meters compensation, a Compressor/Limiter. A stereo 30-band Graphic Equalizer is available on the MAIN outputs for precise correction of the overall frequency response.

Extensive routing capabilities are available in the M 20 Digital Mixers to provide a wide flexibility for your live and studio sessions.

A fast reacting 5-inch capacitive touchscreen, 5 dedicated encoders and 4 menu keys allow an intuitive and immediate control of every function and parameter. You have full control of your live mix, all within one of the most compact systems on the market.

## 2. FIRMWARE UPDATE

### FIRMWARE UPDATE PROCEDURE

1. Download the latest firmware package available on the web page [https://www.rcf.it/en\\_US/products/mixing-consoles/m-series/m-20-firmware-update](https://www.rcf.it/en_US/products/mixing-consoles/m-series/m-20-firmware-update)
2. Unzip the .zip file and copy the **RCF-M20X-xxxx.mpk** file on the root directory of a FAT32 formatted USB stick. Be sure to have one .mpk file only in the USB stick, to avoid file mismatch.
3. Turn on the M 20X digital mixer.
4. Once the boot is completed, pressing SYSTEM button on the left side of the 5" touchscreen display, go to the page SYSTEM > UTILITIES > FIRMWARE UPDATE.

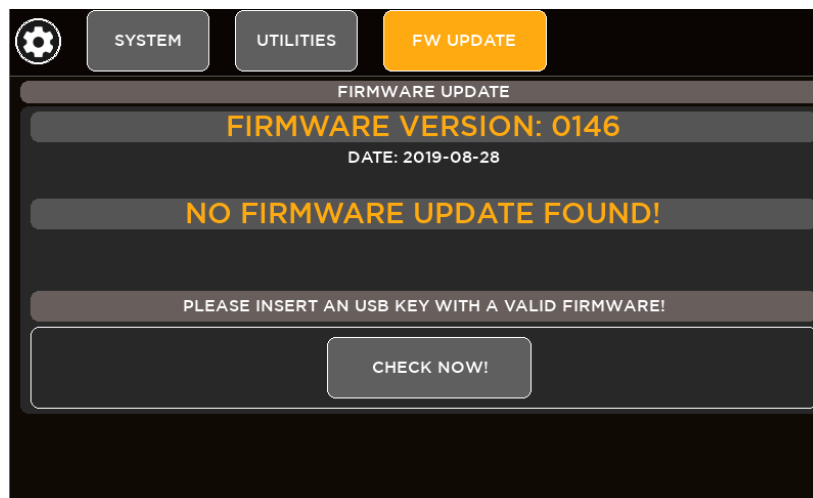

5. Insert your USB stick into the USB A port. The upper side shows the firmware version that is currently installed on the mixer. The bottom side shows the firmware version on the USB stick ready to be installed.
6. If the new package is not automatically detected, please press CHECK NOW

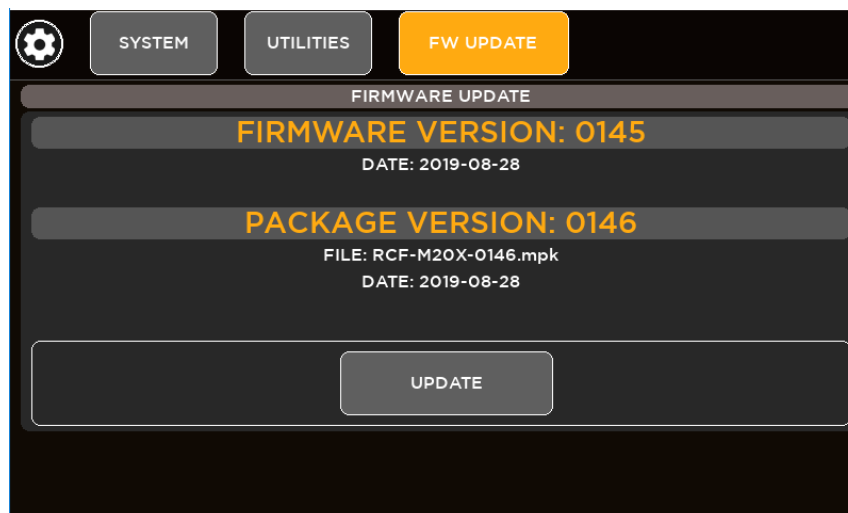

7. Once the new package is detected, press UPDATE and then confirm the system reboot required to apply the new firmware.



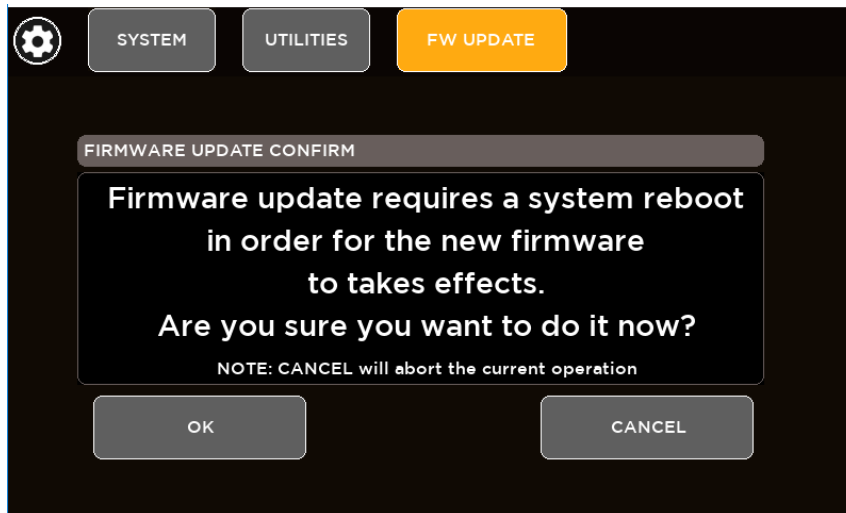

8. After a few seconds you will see a confirmation notice before mixer restart.



9. After rebooting the new features will be ready to be enjoyed.

### 3. BACKUP & RESTORE

M 20 series digital mixers provide backup and restore utilities to save and recall the entire state of the mixer, including all presets, shows and global settings.

#### BACKUP FUNCTION PROCEDURE

1. Go to page SYSTEM > USB STORAGE > BACKUP & RESTORE
2. If you do not connect a USB key drive, this screen will appear:

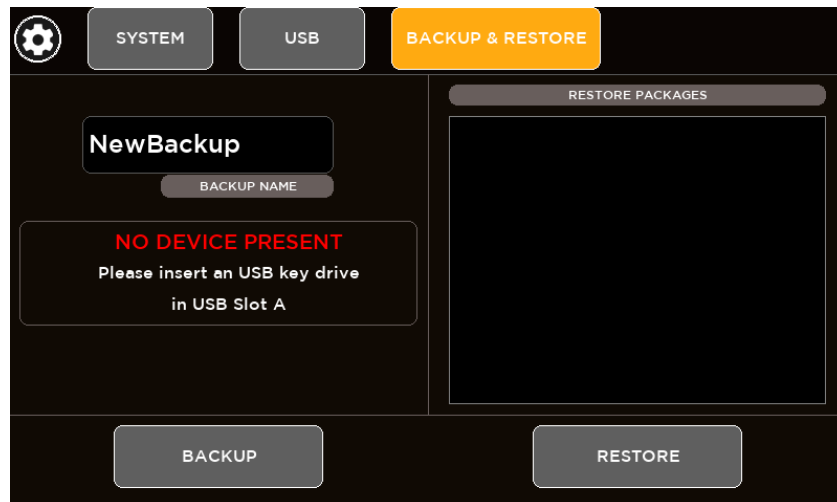

3. Insert your USB stick into the M 20 USB port A

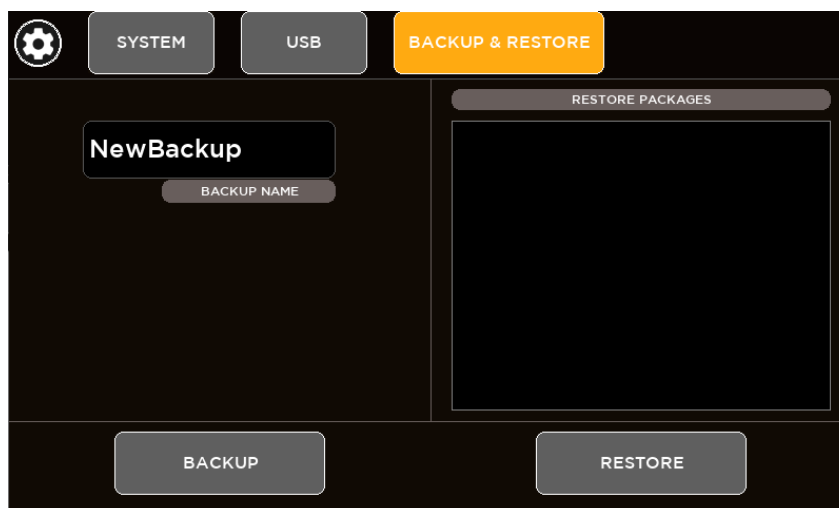

4. Type a name (a single word without space and special characters) of your backup in the BACKUP NAME area and then press the BACKUP button.

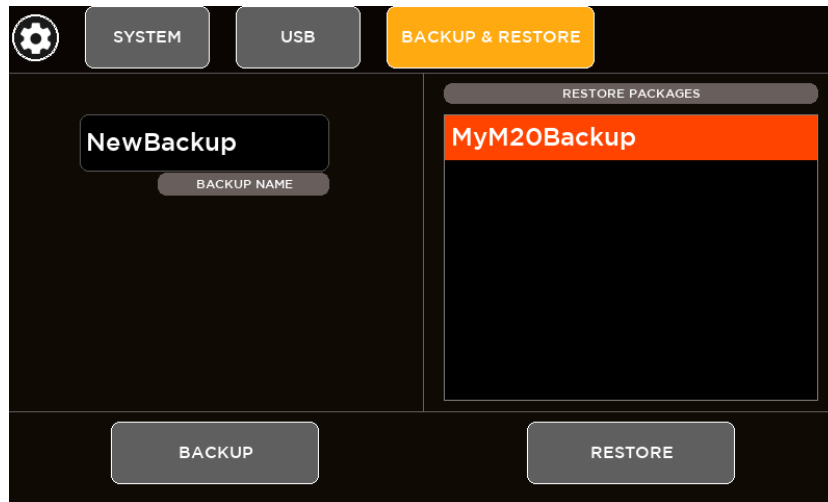

5. A full backup has been successfully created on the root of the USB stick (\* .mbu file). The backup packages will be listed in the box on the right side of the page, ready to be restored.

## RESTORE FUNCTION PROCEDURE

1. Go to page SYSTEM > USB STORAGE > BACKUP & RESTORE
2. If you do not connect a USB key drive, this screen will appear:

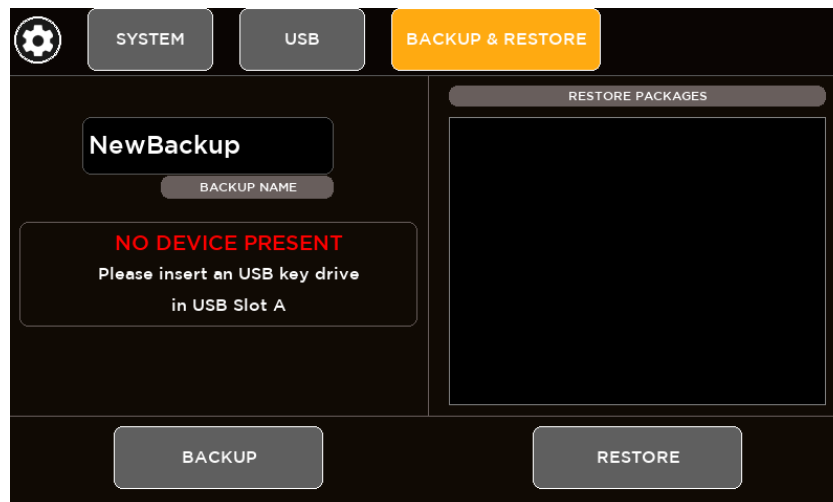

3. Insert your USB stick into the M 20 USB port A

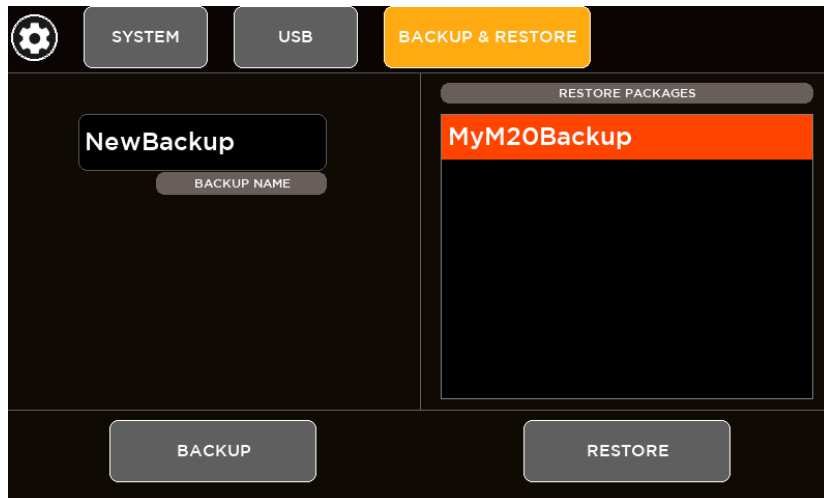

4. From the list box in the right side of the page select the backup package that you want load on your mixer and then press RESTORE button. A message box will appear:

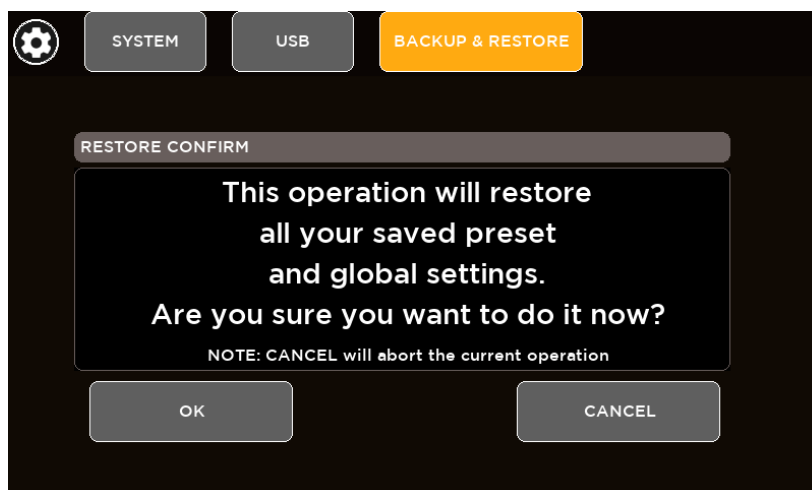

5. If you want to proceed, click on "OK"
6. The restore procedure has been completed

## 4. PROCESSING

Press any SEL button to select a channel and the touchscreen will display the dedicated channel processing. The display will automatically change every time the SEL button is pressed in order to cycling between the single processing pages. It's also possible to select the processing block touching the processing tabs on the upper side of the screen. Once a block is selected, the display changes accordingly and the parameters available in that section are assigned to surface encoders below the screen.

The screenshot shows a channel processing interface for channel 01. At the top, a yellow box highlights the 'Processing Tabs' which include icons for a microphone, EQ, dynamics, and faders. A yellow outline surrounds the main processing area, which is divided into sections for GAIN (20 dB), POLARITY, HPF FREQ (81.3 Hz), and DELAY (0 ms). A red box highlights the 'Encoder parameters' at the bottom, showing 'ANALOG', '20 dB', '81.3 Hz', and '0 ms'. A green box highlights the 'Channel strip area' on the left, showing a meter bar at -7.3 dB and a PAN control set to 'C'. A blue box highlights the 'Processing section' containing touch buttons for POLARITY, HPF, ROUTING, and DELAY. A red box highlights the 'Encoder parameters' at the bottom. A green box highlights the 'Channel strip area' on the left. A red box highlights the 'Encoder parameters' at the bottom. A blue box highlights the 'Processing section' containing touch buttons for POLARITY, HPF, ROUTING, and DELAY. A red box highlights the 'Encoder parameters' at the bottom.

**Channel Number**

**Processing Tabs:** Touch the block or press SEL to change view. The yellow outline indicate the current view. Each block also shows the preview of processing settings.

**Processing section** hold touch buttons and display boxes of to the encoders values

**Encoder parameters** change accordingly to the processing page

This status bar shows the on-off status of each function available on the selected channel.

**Encoder 1** is fixed to PAN control related to the selected Input or Output channel

**Channel strip area** that always shows the principal information of the selected channel: name, meter bar, fader level value, pan value and on-off processing status bar

## INPUT PROCESSING

The Input Processing screen is divided into the following tabs (from left to right):

- CHANNEL
- GATE
- PARAMETRIC EQ
- DYNAMICS
- SENDS

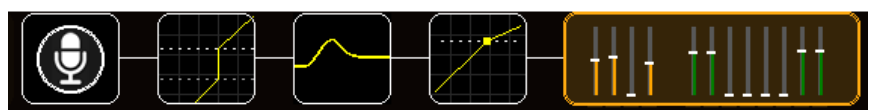

You can touch each of these section to jump to the relevant page.

## CHANNEL SECTION

The first block allow the channel settings accordingly to the input.

### Input channels 1-16

**PREAMP GAIN Value display**

**Phase inverter**

**Phantom Enable**

**HPF frequency value display**

**12 dB/oct HPF On/Off**

**Stereo Pairing Enable**

**Delay Time value display**

**Encoder Parameters assignment**

**Channel Rename Press Enter to confirm**

**Set the Input Routing: for each source type select which input is routed to the selected channel processing**

The CHANNEL parameters assigned to the Encoders are:

**IN SOURCE:** this parameter allows to select the source type between these items:

- ANALOG: Mic Input
- STREAM: 24-track USB audio interface
- SD CARD: 20-track Player

**GAIN:** this parameter set the value of the input gain accordingly to the selected input source

- ANALOG: range [0: 60] dB with step of 1 dB
- STREAM: range [-10: 10] dB with step of 1 dB
- SD CARD: range [-10: 10] dB with step of 1 dB

**HPF FREQ:** this parameter set the value of the HPF cutoff frequency in the range [20: 1k] Hz

**DELAY:** this parameter set the value of the input Delay time in the range [0: 100] ms

## Input channels 17-20

Hardware inputs from 17 to 20 have line connections, with no Phantom option and with the preamp gain parameter in the range [0: 10] dB.



Input channels 19-20 have an additional item in the Source Selector. Besides Analog, Stream and SD Card source, it's possible to select USB Stereo Player as input.

**IN SOURCE:** this parameter allows to select the source type between these items:

- ANALOG: Mic Input
- STREAM: 24-track USB audio interface
- SD CARD: 20-track Player
- DRIVE: USB Stereo Player (for CH19-20 only)

**GAIN:** this parameter set the value of the input gain accordingly to the selected input source

- ANALOG: range [0: 10] dB with step of 1 dB
- STREAM: range [-10: 10] dB with step of 1 dB
- SD CARD: range [-10: 10] dB with step of 1 dB
- DRIVE: range [-10: 10] dB with step of 1 dB

## GATE SECTION

All inputs are equipped with a Noise Gate processor that allows to reduce the output signal by a specific amount (Range) when the input signal level is lower than a specific amount (Threshold). A gain reduction level (visible also when the processor is off) allows to set all parameters before hearing the effective sound.

Switch the Gate On or Off using the on-screen ON button

Viewing Area

Encoder Assignment

Preset View shows the last chosen category of presets. For the GATE block are available 2 banks of presets:

- **USER BANK** – 100 locations where save your custom settings.
- **ROM BANK** – 10 locations with carefully crafted presets.

Press BACK to return to processing page. Choose your preset directly scrolling on the screen or using the Encoder 3 (LIST SEL), then press LOAD to recall it.



The GATE parameters assigned to the Encoders are:

- ATTACK:** this parameter allows to set the value of the Attack Time in the range [1: 1000] ms
- RELEASE:** this parameter allows to set the value of the Release Time in the range [10: 1000] ms
- THRESHOLD:** set the value of the Threshold in the range [-100: 0] dB
- RANGE:** set the value of the Range in the range [0: 60] dB

### PARAMETRIC EQ

All inputs are equipped with a 4-band Parametric EQ that allows an accurate equalization of signal input.

Reset the EQ parameters using the INIT button

Switch the PEQ On or Off using the on-screen ON button

Viewing Area

Encoder Assignment

Select band rotating Encoder 2

ZOOM View allows a more accurate setting of the equalizer curve using touch screen

FREQ	26 Hz	185 Hz	1.0 KHz	4.3 KHz
GAIN	1.4 dB	-10.2 dB	3.4 dB	-8.6 dB
TYPE/Q	SHELF	7.24	2.31	SHELF

BAND SELECT	FREQ	GAIN	TYPE/Q
3	1.0 KHz	3.4 dB	2.31
4	4.2 KHz	-8.6 dB	SHELF

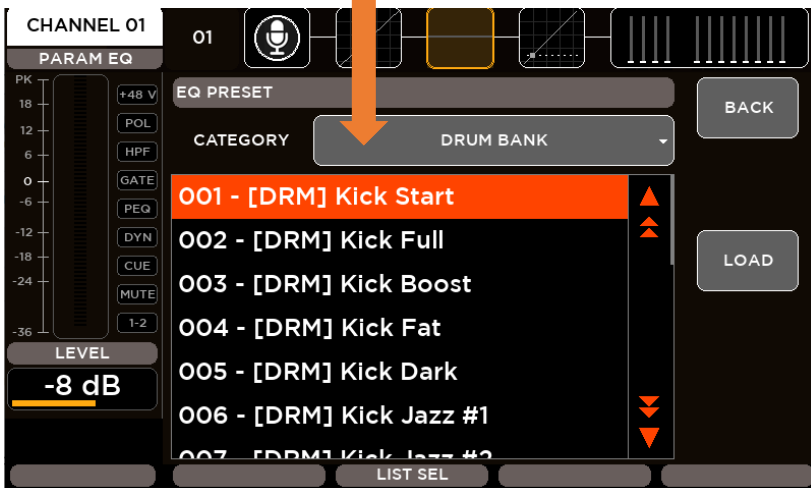
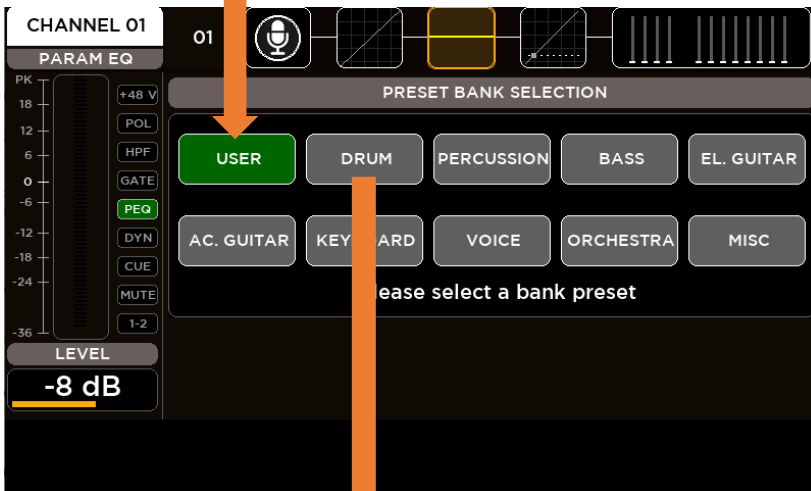
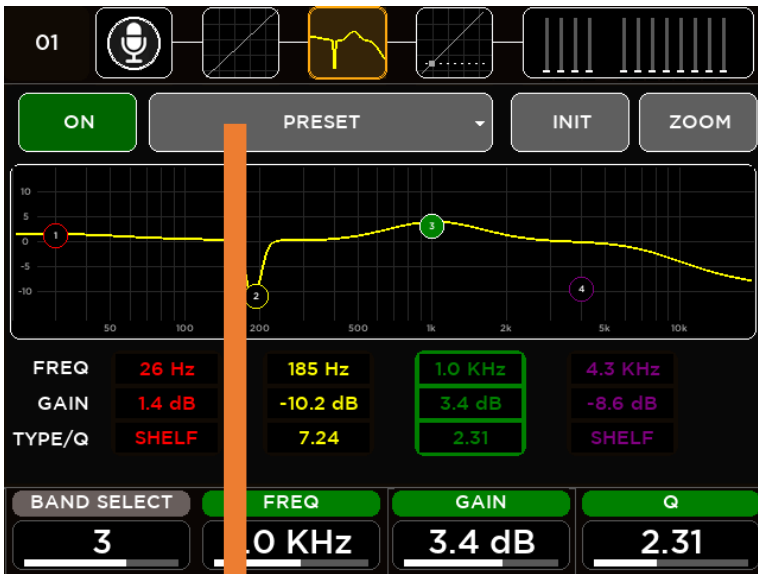

For the input Parametric Equalizers are available 10 banks of presets divided into categories:

- **USER BANK** – 100 locations where save your custom settings.
- **ROM BANKS**
  - **DRUM**  
20 locations with carefully crafted drum presets
  - **PERCUSSION**  
10 locations with carefully crafted percussion presets
  - **BASS**  
10 locations with carefully crafted bass presets
  - **EL. GUITAR**  
10 locations with carefully crafted el. guitar presets
  - **AC. GUITAR**  
10 locations with carefully crafted ac. guitar presets
  - **KEYBOARD**  
10 locations with carefully crafted keyboard presets
  - **VOICE**  
10 locations with carefully crafted voice presets
  - **ORCHESTRA**  
10 locations with carefully crafted orchestra presets
  - **MISC**  
10 locations with carefully crafted miscellaneous presets

Press BACK to return to processing page. Choose your preset directly scrolling on the screen or using the Encoder 3 (LIST SEL), then press LOAD to recall it.

PEQ parameters assigned to the Encoders are:

**BAND SELECT:** this parameter allows to select the single filter band  
**FREQ:** set the value of Frequency of the selected band in the range [20: 20k] Hz  
**GAIN:** set the value of Gain of the selected band in the range [-12: 12] dB  
**TYPE/Q:** this parameter change according to the selected filter band:

- Band1
  - Low SHELF Filter type
  - HP Filter type
  - Peaking Filter Q parameter in the range [1: 20]
- Band2 & Band3
  - Peaking Filter Q parameter in the range [1: 20]
- Band4
  - High SHELF Filter type
  - LP Filter type
  - Peaking Filter Q parameter in the range [1: 20]

DYNAMICS – Compressor/DeEsser

All 16 MIC inputs are equipped with a Dynamics processor that can be setted as **Compressor** or as **De-Esser**.

The screenshot shows a digital mixer's dynamics processor interface for channel 01. It features several control sections: a top section with an 'ON' button and a 'PRESET' dropdown; a middle section with 'ATTACK' and 'RELEASE' knobs (both set to 1 ms), 'THRESHOLD' (-56 dB), 'RATIO' (4.0), and 'POST GAIN' (18.0 dB) controls; a bottom section with 'DE-ESSER' and 'HI PASS' buttons; and a 'FREQ' knob set to 1361 Hz. A graph on the right shows a frequency response curve. A red box highlights the 'ON' button, the 'DE-ESSER' button, and the 'THRESHOLD', 'RATIO', 'POST GAIN', and 'FREQ' controls. A yellow label 'FREQ' is positioned above the 'FREQ' knob. Callouts provide the following information:

- Switch the DYN On or Off using the on-screen ON button:** Points to the green 'ON' button.
- Switch DE-ESSER On to enable the De-Esser mode. Switch DE-ESSER Off to enable the Compressor mode:** Points to the green 'DE-ESSER' button.
- Encoder Assignmen:** Points to the 'THRESHOLD', 'RATIO', and 'POST GAIN' controls.
- When in De-Esser mode select the Filter Type (between High Pass and Band Pass) of the Side Chain and adjust the Frequency:** Points to the 'HI PASS' button and the 'FREQ' knob.
- Viewing Area and assign Parameters:** Points to the frequency response graph.
- The yellow label indicates which parameter has been assigned to ENCODER 5:** Points to the yellow 'FREQ' label above the knob.
- Touch & Adjust function is available for ATTACK, RELEASE and FREQ. Touch one of these parameters and adjust the value using Encoder 5.** Points to the 'ATTACK', 'RELEASE', and 'FREQ' controls.

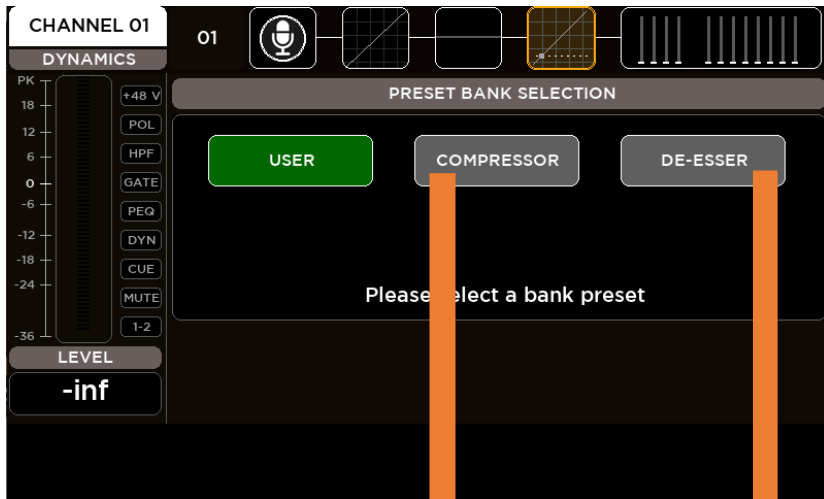

For the input Parametric Equalizers are available 10 banks of presets divided into categories:

- **USER BANK** – 100 locations where save your custom settings
- **ROM BANKS**
  - COMPRESSOR  
10 locations with carefully crafted compressor presets
  - DE-ESSER  
10 locations with carefully crafted de-esser presets

Press BACK to return to processing page.

Choose your preset directly scrolling on the screen or using the Encoder 3 (LIST SEL), then press LOAD to recall it.

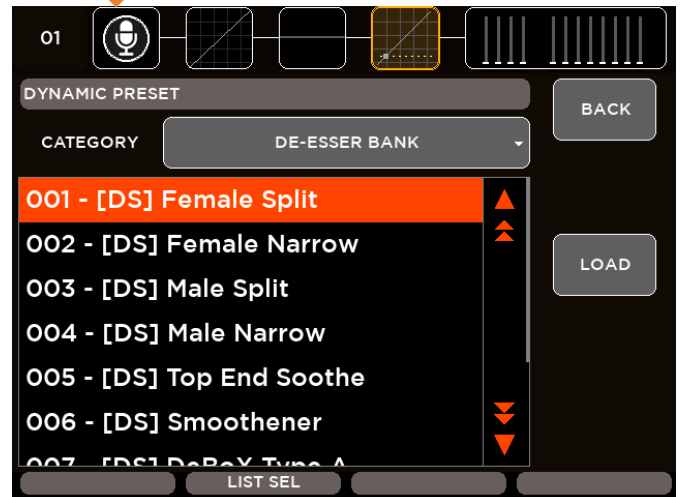
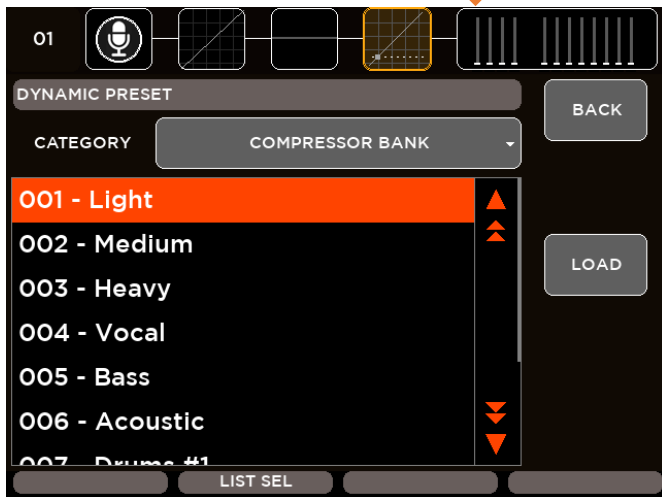

DYN parameters assigned to the Encoders are:

**THRESHOLD:** set the value of the compressor threshold in the range [-80: 0] dB

**RATIO:** set the value of the Ratio in the range [1: 20]

**POST GAIN:** set the value of Gain of in the range [-30: 30] dB

**ASSIGNABLE:** this parameter change according to the selected parameter:

- **ATTACK:** set the value of the Attack Time in the range [1: 1000] ms
- **RELEASE:** set the value of the Release Time in the range [1: 1000] ms
- **FREQ:** set the value of the Side Chain Frequency in the range [200: 8000] Hz

## SENDS

For each input channel, the SENDS page allows to control all channel sends to every mix bus: FX [1-4], MIX [1-8], and APFL. For each send-on-mix are available different parameters: Pre/Post, on/off and Level. The encoder parameters change according to the selected block send-on-mix.

**APFL channel send**

- PRE / POST
- ON/OFF

**4 FX channel sends**

- PRE / POST
- ON/OFF
- Level

**DCA and MUTE GROUPS assignment**

**8 MIX channel sends**

- PRE / POST
- ON/OFF
- Level

**Select Send block by moving Encoder 2**

**Encoder Assignment**

The SENDS parameters assigned to the Encoders are:

**SEND SEL:** this parameter allows to select the single send-on-mix block

**PRE/POST:** this parameter allows to select if the selected send-on-mix is Pre or Post Fader

**ON/OFF:** this parameter allows to enable or disable the selected send-on-mix

**LEVEL:** according to the send type, this parameter allows to set the send level in the range [-inf: +10] dB

### CHANNEL PRESET

M 20 digital mixers provide 100 locations where save your custom settings of all input processing chain. Press **BACK** to return to processing page. Choose your preset directly scrolling on the screen or using the Encoder 3 (**LIST SEL**), then press **LOAD** to recall it.

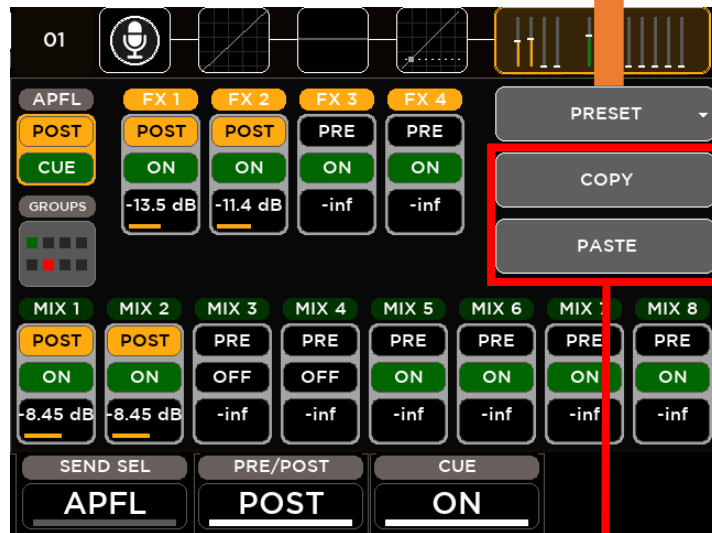

### COPY & PASTE

M 20 digital mixers provide the possibility to copy the current processing parameters of a channel and to paste them to other channels. Press **COPY** on the channel that you want to replicate. Go to desiderata channel, press **PASTE** and select which processing blocks you want to overwrite selecting the relative buttons.

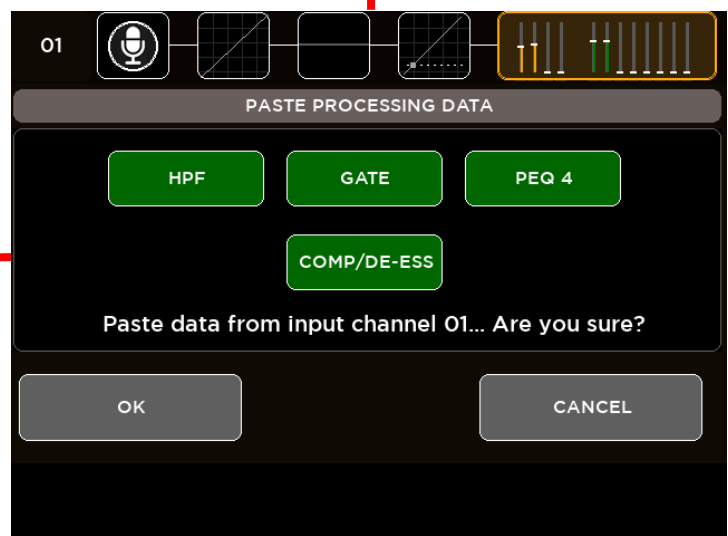

## OUTPUT PROCESSING

A complete processing section is available on all outputs: a flexible 8-band parametric EQ with several selectable modes, that also allow different slopes, a delay with up to 85 meters compensation, a compressor/limiter. A stereo 30-band graphic equalizer is available on the MAIN outputs for precise correction of the overall frequency response. Extensive routing options allows flexible use of physical outputs.

The MIX [1:8] output processing screen is divided into the following tabs:

- CHANNEL VIEW
- PARAMETRIC EQ
- DYNAMICS



The Main LR processing screen is divided into the following tabs:

- CHANNEL VIEW
- GRAPHIC EQ
- PARAMETRIC EQ
- DYNAMICS

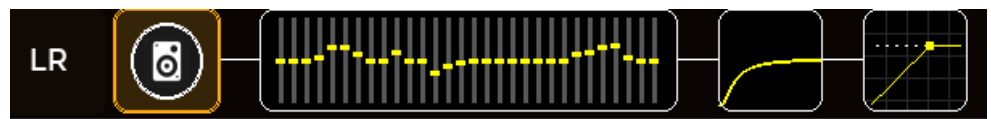

Similarly to the input channels, the left side of the screen doesn't change when navigate between the processing pages of the channel. The left column is the Channel strip that shows the principal information of the selected channel: name, meter bar, fader level value, balance value (for the stereo channels) and on-off processing status bar.

**On-Off processing status bar**

**Output Channel**

**Processing Tabs:** Touch the block or press SEL to change view. The yellow outline indicate the current view. Each block also shows the preview of processing settings.

**Channel Name**

**Current Page**

**Meter bar**

**Fader Level Value**

**Balance Value**

**Encoder parameters** change accordingly to the processing page

## CHANNEL VIEW

The first page allows the channel settings accordingly to the output.

**CHANNEL PRESET**  
 M 20 digital mixers provide 100 locations where save your custom settings of all input processing chain.  
 Press **BACK** to return to processing page.  
 Choose your preset directly scrolling on the screen or using the Encoder 3 (**LIST SEL**), then press **LOAD** to recall it.



Send the output mix channel to:

- APFL bus to monitoring and analyzing the audio mix
- LR bus if you want to use mix as a subgroup

**DCA and MUTE GROUPS assignment** (points to GROUPS button)

**Stereo Pairing Enable** (points to LINK 1-2 button)

**Encoder Parameters** (points to SELECT, PRE/POST, CUE, DELAY buttons)

**Channel Rename (Press Enter to confirm)** (points to MIX OUT 01 CHANNEL NAME)

**APFL, LR, PRE, CUE, ON, COPY, PASTE** (grouped in a red box)

**COPY & PASTE**  
**COPY** the current processing parameters of an output and to paste them to other outputs.  
 Go to desiderata output, press **PASTE** and select which processing blocks you want to overwrite selecting the relative buttons.

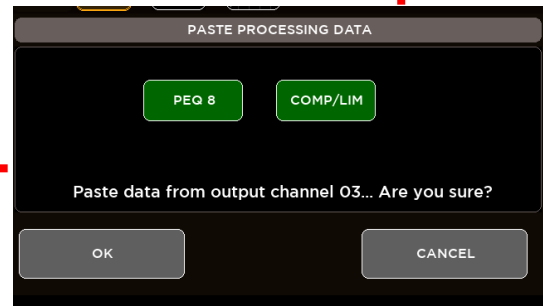



CHANNEL VIEW parameters assigned to the Encoders are:

**SEND SEL:** this parameter allows to select the send-on-mix block:

- Send to APFL (for LR and MIX outputs)
- Send to LR (for MIX outputs only)

**PRE/POST:** this parameter allows to select if the selected send-on-mix is Pre or Post Fader

**ON/OFF:** this parameter allows to enable or disable the selected send-on-mix

**DELAY:** this parameter set the value of the input Delay time in the range [0: 250] ms

### 8-Band PARAMETRIC EQ

All outputs are equipped with an 8-band Parametric EQ that allows an accurate equalization of signal output and that can be configured in various operating modes: the first two and last two bands have selectable filter types, and they can be combined into a single, 24-dB/oct HPF or LPF. This also allows for crossover filtering, useful in combination with the extensive routing capabilities, when a subwoofer is connected to one of the MIX outputs.

For the output Parametric EQ, 100 locations are available where your custom settings can be saved and recalled

Reset the EQ parameters using the INIT button

Switch the PEQ On or Off using the on-screen ON button

ZOOM View allows a more accurate setting of the equalizer curve using touch screen

Viewing Area

Touch these boxes to select a band and automatically assign last 3 encoder to the related parameters

Encoder parameters change according to the selected band

Select band moving Encoder 2

BAND SELECT	FREQ	GAIN	Q
6	1.5 KHz	1.4 dB	5.98

## PEQ8 Operating Modes



PEQ parameters assigned to the Encoders are:

**BAND SELECT:** this parameter allows to select the single filter band

**FREQ:** set the value of Frequency of the selected band in the range [20: 20k] Hz

**GAIN:** set the value of Gain of the selected band in the range [-12: 12] dB

**TYPE/Q:** this parameter change according to the selected filter band:

- Band1
  - Low SHELF Filter type
  - High Pass 12 dB/oct Filter type
  - High Pass 24 dB/oct Filter type → Band1 combined with Band2
  - Peaking Filter Q parameter in the range [1: 20]
- Band2, Band3, Band4, Band5, Band6, Band7
  - Peaking Filter Q parameter in the range [1: 20]
- Band8
  - High SHELF Filter type
  - Low Pass 12 dB/oct Filter type
  - Low Pass 24 dB/oct Filter type → Band7 combined with Band8
  - Peaking Filter Q parameter in the range [1: 20]

## DYNAMICS – Master Compressor/Limiter

All outputs are equipped with a Dynamics processor configured as a Compressor/Limiter

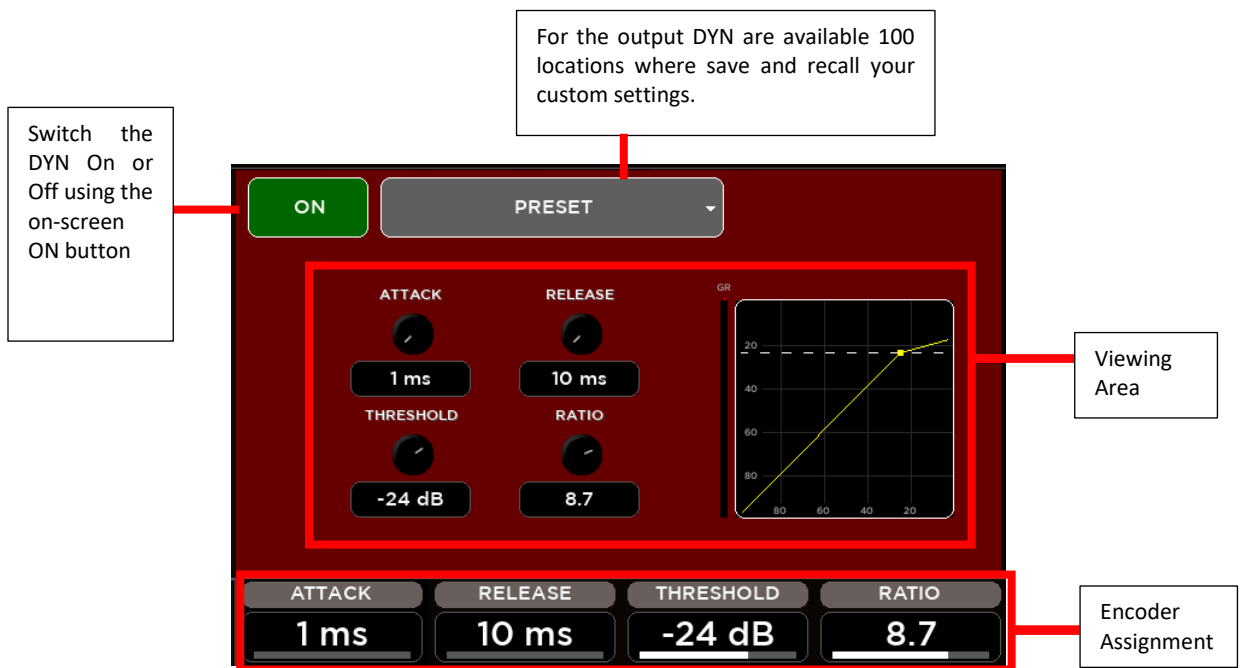

DYN parameters assigned to the Encoders are:

**ATTACK:** set the value of the Attack Time in the range [1: 1000] ms

**RELEASE:** set the value of the Release Time in the range [10: 1000] ms

**THREASHOLD:** set the value of the compressor threshold in the range [-80: 0] dB

**RATIO:** set the value of the Ratio in the range [1: 20]

## 30-Band GRAPHIC EQ

The Main OUT processing provides a 30-Band GEQ with the center frequency of each band spaced 1/3 of an octave away from the center frequency of the adjacent bands, so that three bands (three sliders on the front panel) cover a combined bandwidth of one octave.

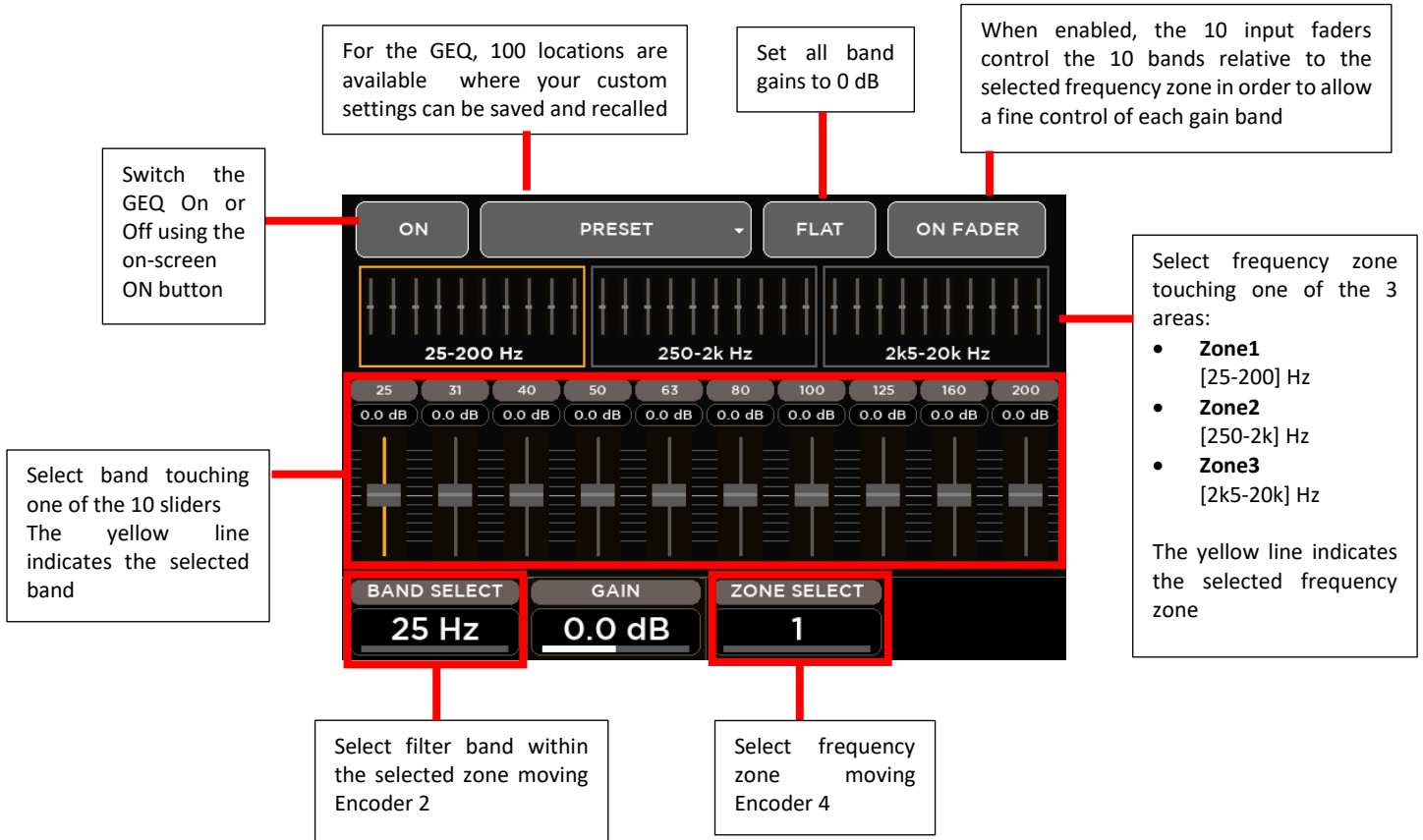

GEQ parameters assigned to the Encoders are:

**BAND SELECT:** select one of the 10 bands for each selected zone

- **Zone1** Bands: 25, 31, 40, 50, 63, 80, 100, 125, 160, 200 Hz
- **Zone2** Bands: 250, 315, 400, 500, 630, 800, 1k, 1k25, 1k6, 2k Hz
- **Zone3** Bands: 2k5, 3k15, 4k, 5k, 6k3, 8k, 10k, 12k5, 16k, 20k Hz

**GAIN:** set the value of the selected band in the range [-12; +12] dB

**ZONE SELECT:** select the frequency zone

## EFFECTS

All M 20 models boast 4 stereo FX engines available on dedicated buses, offering two high quality digital reverbs, a programmable delay and a 4th effect which can be configured as a modulation or a second delay. All FX Engines offer multiple algorithms to match the specific needs of a show. The internal effects pages are accessible through the FX button on the left side of 5" TFT Display or through the SEL button on each Master FX strips.

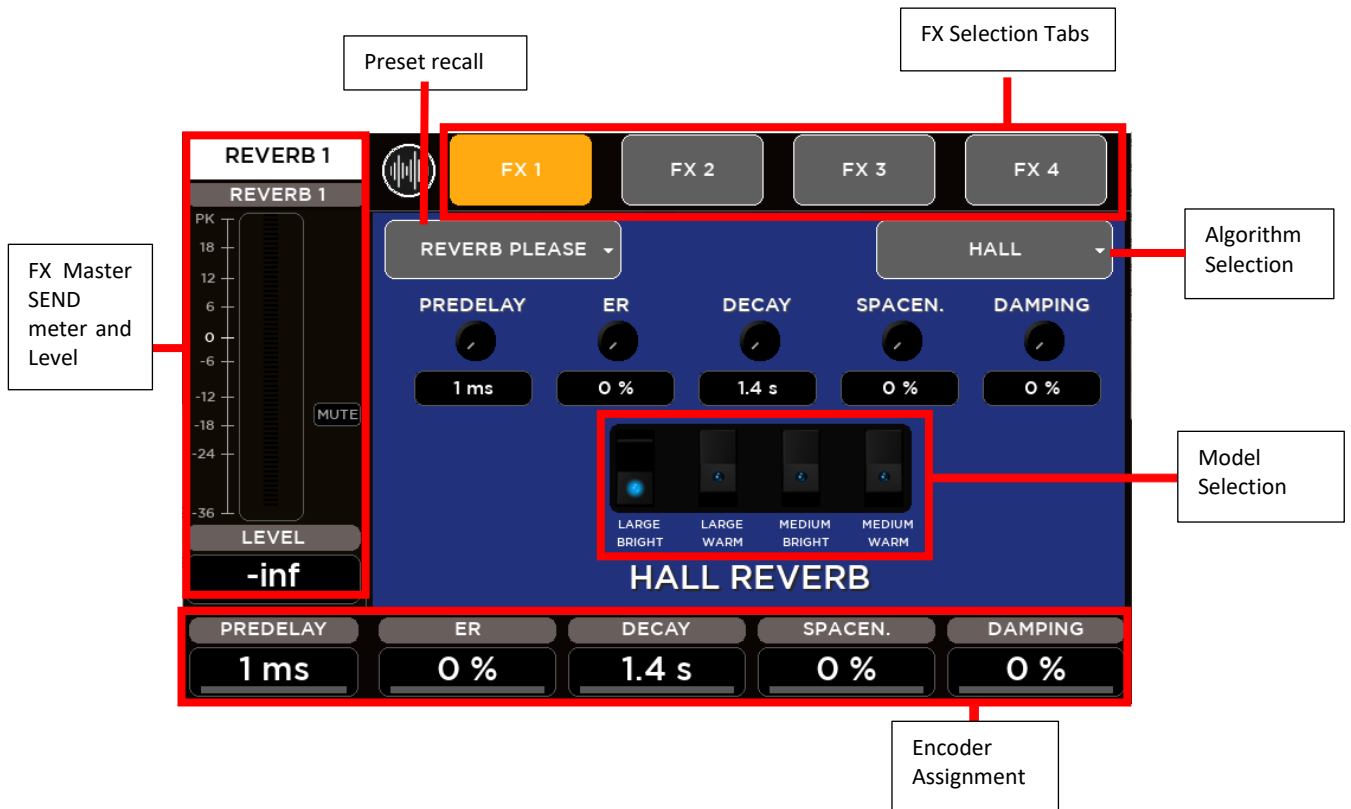

### FX ALGORITHM LIST

#### FX1 – REVERB

- HALL: Large Bright/Warm, Medium Bright/Warm
- PLATE: Vintage, Modern
- ROOM: Medium Bright/Warm, Small Bright/Warm
- AMBIENCE: 2 models

#### FX2 - REVERB

- same Reverb models as FX1

#### FX3 - DELAY

- Stereo
- Modern
- Vintage
- Dual
- ER

#### FX4 – DELAY or MODULATION

- same Delay models as FX3
- Chorus
- Flanger
- Tremolo

## REVERB

The M Series provides two simultaneous full **Digital Reverbs** available on Send **FX1** and Send **FX2**. Digital Reverb is a very intuitive and smooth sounding processor and represents an essential ingredient of the final mix. Great care has been taken to provide the highest quality algorithms and presets.



Based on 12 algorithms, it allows to easily find the perfect reverberation for every kind of application in a few clicks. The algorithms are been designed and tailored to focus immediately the sound you are looking for and then fine tune it with the essential parameters available through the five pots.

The algorithms are also available in some cases into two variations (Bright/Warm or Digital/Vintage) to further help in selecting the proper starting point.

Four different reverb types are available:

TYPE		VARIATIONS
<b>Hall</b>	usually perfect for smooth and deep reverberations	large/medium warm/bright
<b>Room</b>	the algorithm to start with if you are looking for hi impact reverberations	large/medium warm/bright
<b>Plate</b>	classic “all purpose” algorithm with unique character	digital/vintage
<b>Ambience</b>	the first choice if you are looking for something to expand the stereo field or to somehow enhance the sounds	model 1, model 2

You can create your own configurations for **Hall** and **Room** by modifying the following parameters:

- Pre-delay (delay before reverb)
- ER (amount of primary reflections)
- Decay (time decay)
- Spaceness (percentage of spatialization)
- Damping (percentage of absorption of the higher frequencies)

**Plate** reverb parameters:

- Smoothness
- Colour

**Ambience** reverb parameters:

- Richness

**TIP**

The reverberation is one of the most crucial signal processors to achieve a correct mix, so it's very important to use it with care. Often the reverberation of the venue affects our overall sound, especially because usually the sound check is done without audience that is another element that can drastically change the reverberation time of the venue. So keep in mind to evaluate the reverberation time of the empty venue, and then consider that it will be shorter with the audience during the live gig; for these reasons, it could be useful to check the amount of the reverb also on headphones.

DELAY

The M Series provides two simultaneous full **Digital Delays** available on Send **FX3** and Send **FX4**.

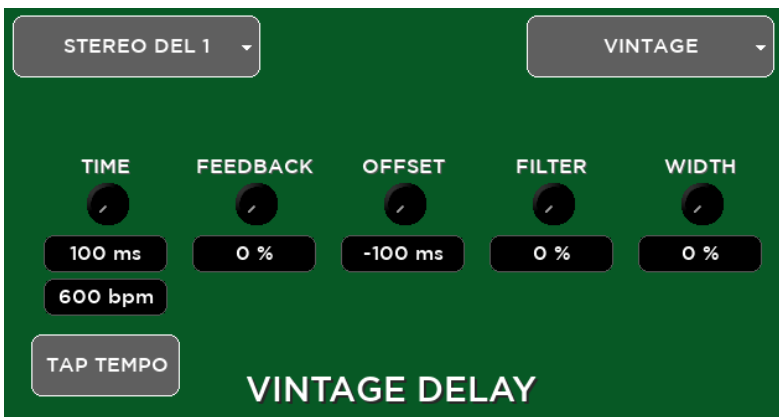

Five different delay types are available:

TYPE		VARIATIONS
<b>Stereo</b>	usually perfect for smooth and deep reverberations	large/medium warm/bright
<b>Vintage</b>	the algorithm to start with if you are looking for hi impact reverberations	large/medium warm/bright
<b>Modern</b>	classic "all purpose" algorithm with unique character	digital/vintage
<b>Dual</b>	the first choice if you are looking for something to expand the stereo field or to somehow enhance the sounds	model 1, model 2
<b>ER</b>	Early reflections to simulate the sound of a room without introducing an audible tail	

You can create your own settings for **Stereo** and **ER** by changing the following parameters:

- Time (length of the delay)
- Feedback (% of delay feedback)
- Lo Cut (low cut filter frequency)
- Hi Cut (high cut filter frequency)
- Width (amplitude)

**Vintage** delay parameters:

- Offset (offset time compared with main Time) instead of Feedback
- Filter (da 0,00 a 100) is a Band-pass filter

**Modern** delay parameters:

- Offset (offset time related to main Time) instead of Feedback
- LoCut (low cut filter frequency) instead of Hi Cut.

**Dual delay** parameters:

- Factor (1/2, 1/3, 1/4, 1/6, 1/8 and 1/16) instead of Feedback
- Feedback 2 (% of delay 2 feedback) instead of Hi Cut

## MODULATION

The M Series provides a **Modulation** processor available on Send **FX4**. The Modulation processor can be configure as Chorus-Flanger or as Tremolo effect.



**Chorus-Flanger** parameters:

- Rate (frequency swing)
- Width (amplitude)
- Depth (depth swing)
- Feedback (% effect feedback)
- Blend (% mix between dry signal and processed)

**Tremolo** parameters:

- Rate (frequency rate)
- Depth (depth swing)



## FX RETURN

For each effect is available an FX RETURNS send-on-mix page accessible through the first four SEL buttons on the FX RET – CUSTOM faders layer.

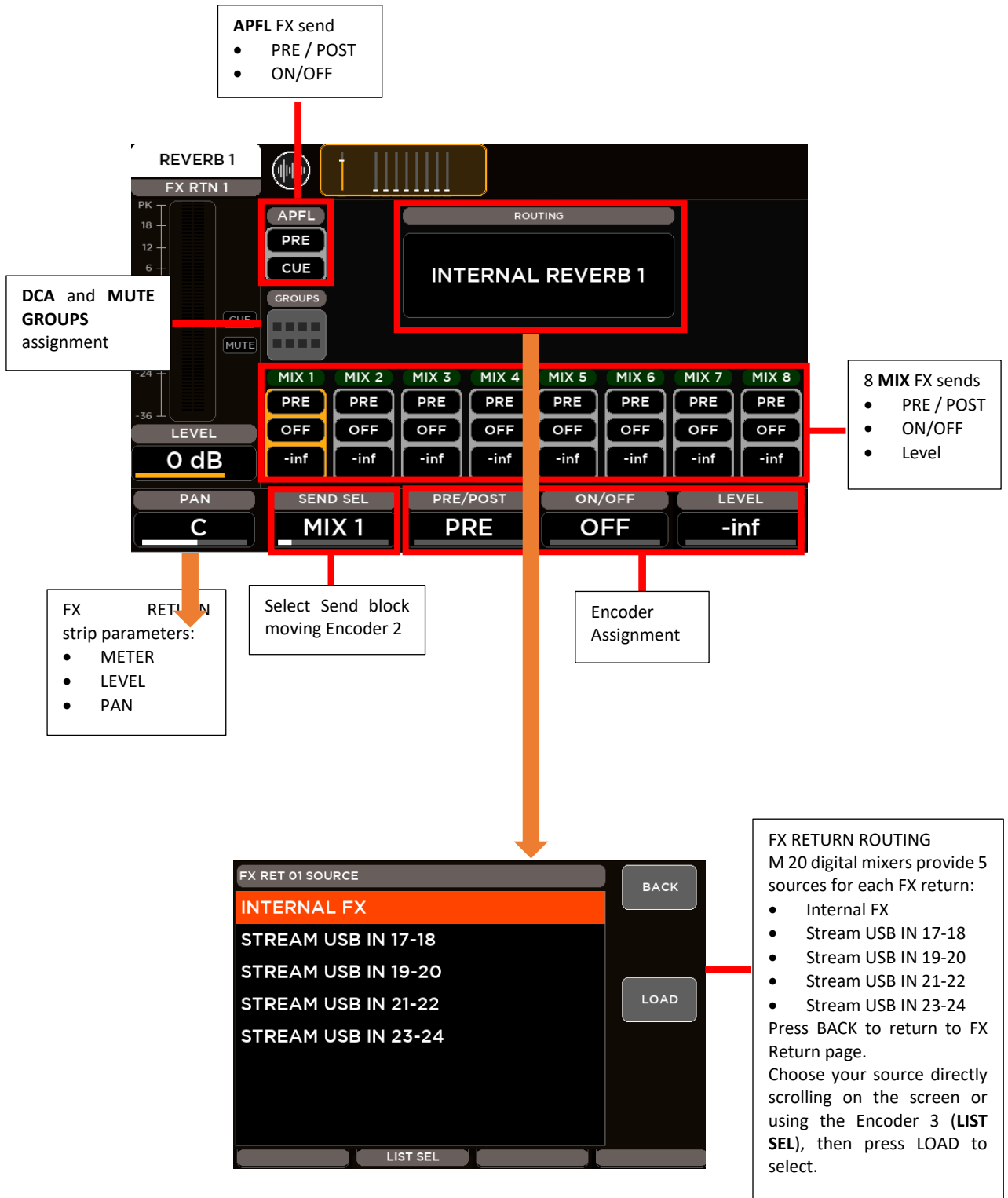

## MONITORING

Through the **HOME** button is possible to enter in the monitoring pages, organized into two tabs: **METERS** and **RTA**



### METERS

A dedicated page is available to monitor all Input, Output, FX signal levels of your session. This page also contains all mutes on/off information, channel stereo pairing indication and Gain Reductions indication for all dynamics processors available on inputs and outputs (Gate, Compressor/DeEsser and Master Compressor/Limiter). As additional information, the last loaded show is shown on the upper side of the page.

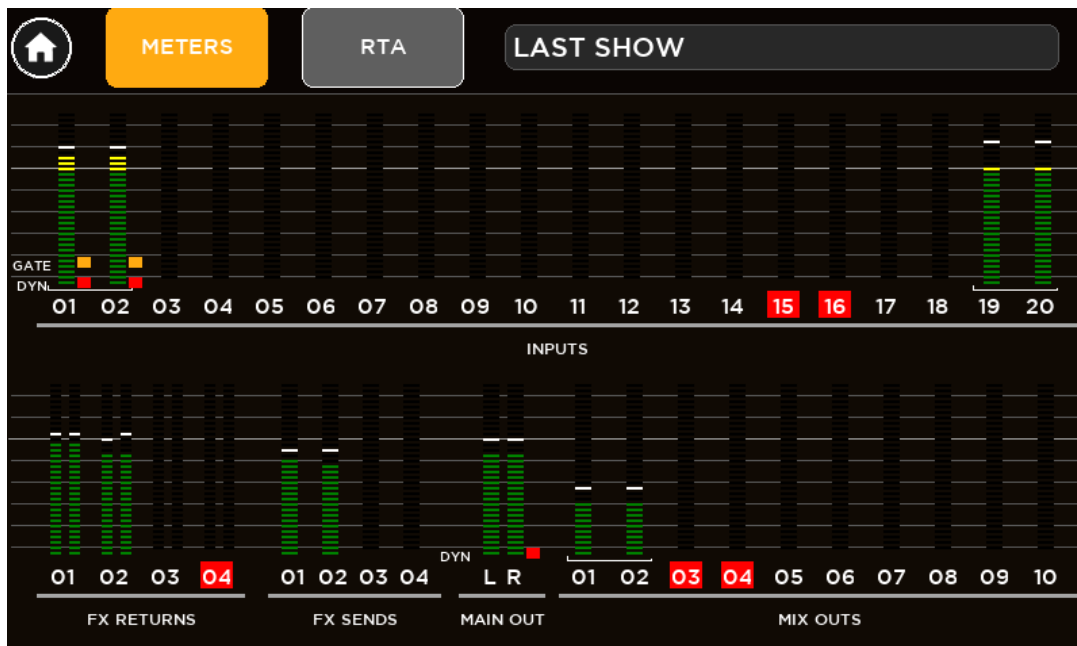

### RTA

M 20 Series Digital Mixers provide a **Real-Time Analyzer** available on the CUE bus. In this way is possible to analyze the frequency content of the audio signal of all Inputs, Outputs and FX Returns with CUE button activated. For each channel, CUE activation is shown with a yellow square behind the channel number.

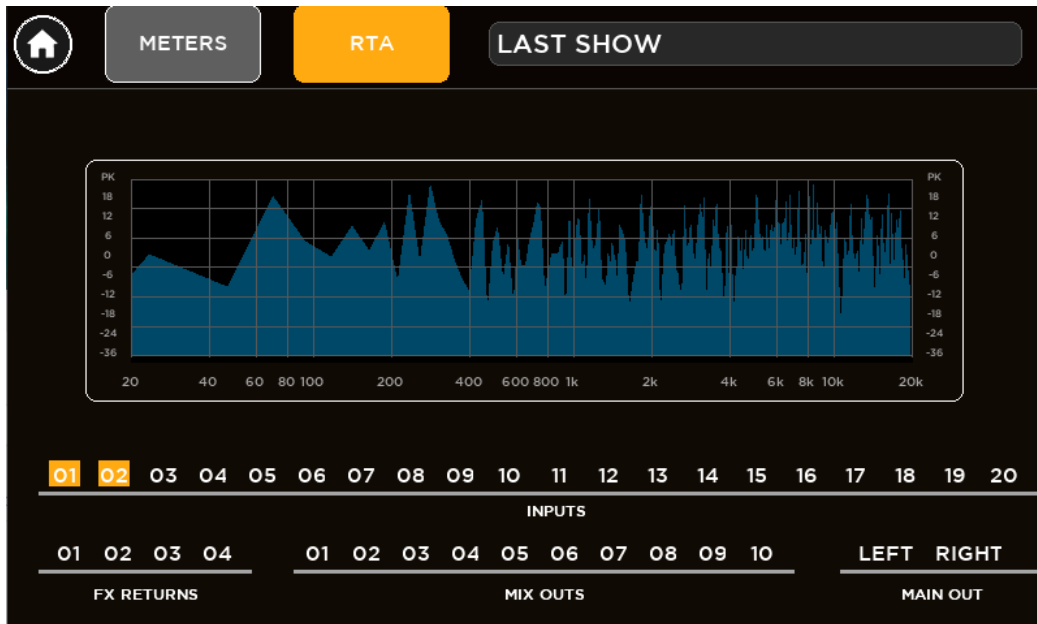

## PHONES

If one or more CUE are activated, the CUE ACTIVE led is on and the audio signal of CUE bus is routed to PHONES output and monitored by the Vu-Meter bars on the right side of the 5" TFT Display. Otherwise, when no CUE is activated, the CUE ACTIVE led is off and the audio signal of MAIN LR output is routed to PHONES output. The Vu-Meter bars will show the Master Level of the selected MIX.



## PLAY/REC

The M 20 Series Digital Mixers offer both Multitrack Player/Recorder and Stereo Player/Recorder that can be combined together for high versatility. Different Play/Rec modes correspond to different external storage devices:

- **Multitrack** Player/Recorder manage up to 20 tracks from/to **SD Card**
- **Stereo** Player/ Recorder manage stereo tracks from/to **USB Mass Storage** device (USB pen drive, or external HDD) in different file formats

From PLAY/REC button on the left side of display you access PLAY, REC and SETUP pages.

## SETUP

SETUP page allows to configure the Player and Recorder modes. The allowed possibilities are:

**STEREO Player / STEREO Recorder**  
Playback and recording from USB Drive.

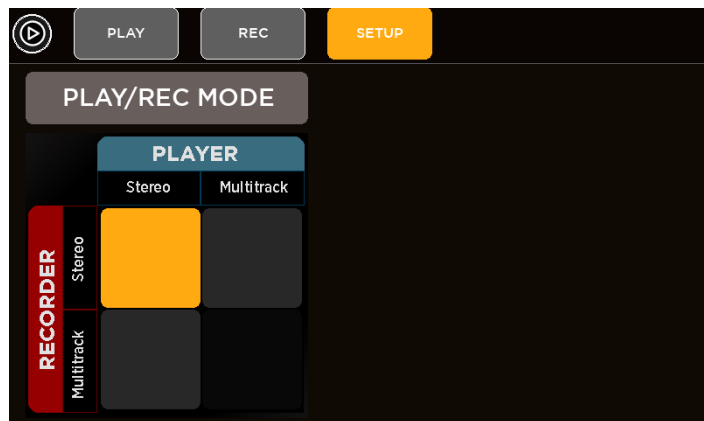

**MULTITRACK Player / STEREO Recorder**  
Playback from SD Card and record to USB drive.

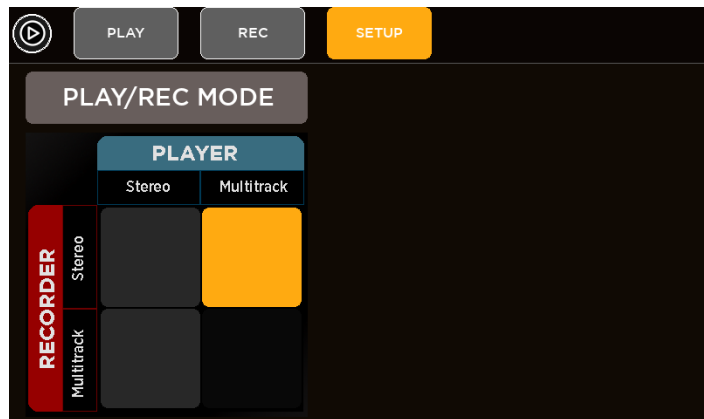

**STEREO Player / MULTITRACK Recorder**  
Playback from USB drive and record to SD Card.  
In Multitrack Recorder mode, according to your live session, it's possible to select the number of recording tracks to optimize the SD Card files size.

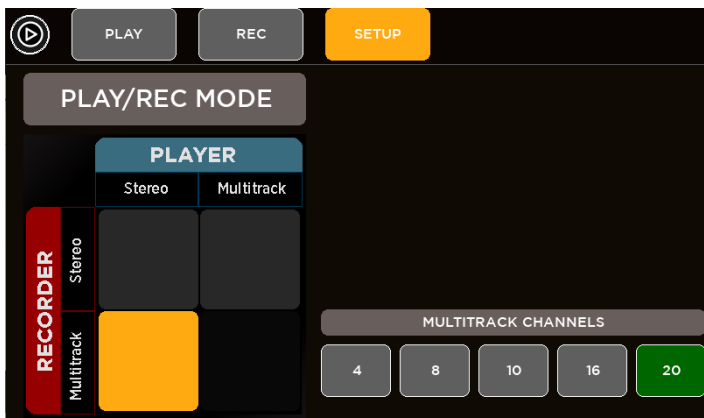

## PLAYER

The internal PLAYER change in Stereo Mode or Multitrack Mode according to the SETUP configuration. The PLAY tab allows to control the playback functions.

When in **STEREO** mode, a flexible stereo file player can access USB mass storage devices (up to four different drives), with arbitrary sample rate, in MP3, WAV and AIFF formats.

**AUTO Mode**  
When the current song reaches the end, the next track is automatically loaded and played.

**USB key select (STEREO mode)**  
Up to 4 USB flash drives can be managed; this is required in case multiple USB flash drives are connected through a USB hub.

**SD CARD (MULTITRACK mode)**

*Recognized device info*

MULTITRACK PLAYER AUTO SD CARD MOD\_SDHC

demo1.wav

Current Song

**Scroll bar**  
Shows the current position within the file. You can grab the scroll bar and move to the desired position, either when in playback mode or stop mode.

**Playback bar**

- Play/Pause
- Previous track
- Next track
- Elapsed Time
- Remaining Time

**FILE BROWSER**  
Navigate through the device folder and choose your song directly scrolling on the screen or using the Encoder 3 (**LIST SEL**), then press OK to select it.  
Press CANCEL to return to Player page.

PLAY REC SETUP

STEREO PLAYER AUTO USB KEY 1 SDISKCYAN

Gaslighting abbie - Steely Dan.wav

Sandro keydrive

00:02:22 00:03:31

PLAY REC SETUP

BROWSE SONGS

/media/sda1

CANCEL OK

<--

APx500\_4.4.2

Audio

Doc

M18

RCF610

REC

LIST SEL

When in **MULTITRACK** mode, the 20-tracks file player can access SD Card, in multichannel WAV format, and is enabled only for 48 kHz sample rate.



Stereo Player files can be reproduced by channels 19-20 according to channel routing.



Multitrack Player files can be reproduced on the corresponding channels when SD CARD source is selected for each channel.

### RECORDER

The REC tab allows high-quality, stereo or multitrack recordings according to the SETUP configuration. The currently available format is 24-bit, 48 kHz (the internal sample rate of the M 20 Digital Mixer).

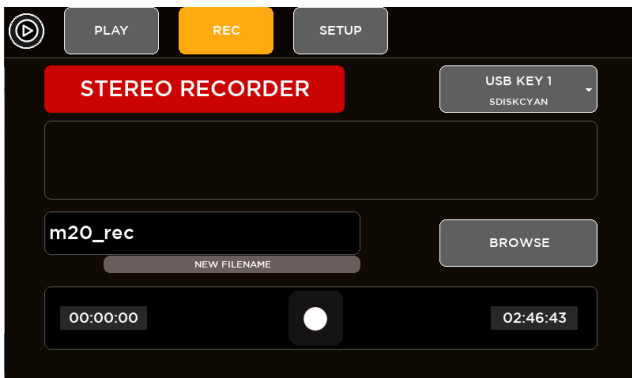

When in STEREO mode, all stereo recordings are stored in the /REC folder within the USB Mass Storage devices (up to four different drives), with source points fully configurable through the IO routing page.

When in MULTITRACK mode, all multichannel recordings are stored in the /REC folder within the SD Card, with channels tap points configurable through the IO routing page. You can record all 20 input channels or you can configure your recorder with a reduced number of channels to optimize the SD Card files size.

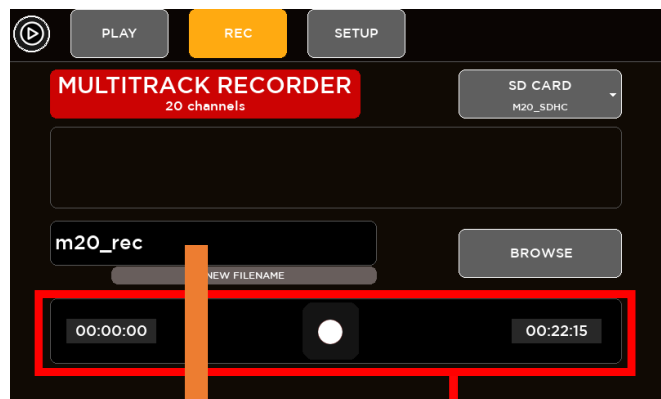

A default name is generated if no specific name is entered, of the form m20\_rec\_XXXX\_0.wav, where XXXX is a numeric counter to ensure a unique filename.

To modify the filename touch this area and type the new file name; press Enter to confirm

Record bar

- Rec/Stop
- Elapsed Time
- Remaining Time (size available on your device)

FAT32 is the only supported file format on M series digital mixers and is also the safest cross-platform (Mac / PC) format. Avoid FAT16 formatting, as random problems in audio file playback have been noticed.

Please notice that the minimum supported device size for audio recording is 4 GB (mainly due to variations if formatting results for smaller sized devices).

For **STEREO** mode, USB 3.0 compatible storage devices are recommended, as these guarantee higher data throughput. Furthermore, consistent and error-free results have been obtained with premium, good-quality USB pens. Several lower-quality devices can cause random errors due to their lower data transfer performance. We have found that on several USB devices it is recommended to have at least 50% free space on the USB key; beyond this percentage, most USB keys show significant fragmentation and in this case, glitches can appear in recorded files.

For **MULTITRACK** mode, SDHC and SDXC formats are supported.

Due to filesystem limitations, the internal recorder can generate a file with maximum size of 4 GB, corresponding to about 4 hours of continuous stereo recording or 20 minutes of continuous 20 channels recording. If this limit is exceeded, the recorder closes the current file and creates another file with no audio gap, without interrupting the recording process. Thus, the complete recording can be reconstructed on audio editing software.

In case you need to reformat a USB pen or SD Card for audio recording, the M 20 digital mixer provides Format tools between the System utilities.

## 5. Technical Specifications

INPUTS	
MIC preamps CH 1-8	XLR input connectors
	Gain range = 60 dB
	Input impedance = 3.3 k $\Omega$
	Maximum input level = +18dBu
MIC/LINE preamps CH 9-16	COMBO input connectors
	Gain range = 60 dB
	Input impedance (XLR/TRS) = 3.3 k $\Omega$ / 12.8 k $\Omega$
	Maximum input level (XLR/TRS) = +18dBu / 29dBu
Balanced Line inputs CH 17-18	2 channels 1/4" TRS jack
	Input impedance = 18 k $\Omega$
	Maximum input level = +18 dBu
Unbalanced inputs CH 19-20	Stereo 3.5mm mini jack
	Input impedance = 15 k $\Omega$
	Maximum input level = +18 dBu
OUTPUTS	
MAIN LR	Balanced XLR
	Output impedance = 50 $\Omega$
	Maximum output level = +24 dBu
MIIX 1-8	Balanced XLR
	Output impedance = 150 $\Omega$
	Maximum output level = +24 dBu
OUT 9-10, routable	2 channels 1/4" TRS jack
	Output impedance = 150 $\Omega$
	Maximum output level = +24 dBu
Digital output, routable	AES3 (XLR)
DSP ENGINE	
Processing	32-bit floating-point, 48 kHz Sample Rate
Internal Mixing Matrix	28 x 16
INPUT PROCESSING	
CH 1-16	Hi-Pass filter
	Delay (up to 100 ms)
	Gate
	4-band Parametric EQ
	Compressor / De-Esser
CH 17-20	Hi-Pass filter
	Delay (up to 100 ms)
	Gate
	4-band Parametric EQ



OUTPUT PROCESSING	
MIX 1-8 (option to link in stereo pairs)	8-band Parametric EQ
	Compressor/Limiter
	Delay (up to 250 ms)
MAIN LR output (with Stereo/Mono switch)	30-band Graphic EQ
	8-band Parametric EQ
	Compressor/Limiter
PAFL	Delay (up to 250 ms)
	Real-Time Analyzer
INTERNAL FX (4x Z-CORE FX Engine)	
FX1 bus	Stereo Reverb (Hall, Plate, Room, Ambience)
FX2 bus	Stereo Reverb (Hall, Plate, Room, Ambience)
FX3 bus	Stereo Delay (Stereo, Modern, Vintage, Dual, ER)
FX4 bus	Stereo Delay / Modulation (Chorus, Flanger, Tremolo)
ON-BOARD MULTITRACK	
SD Card Play/Rec	Recording: 20 channel WAV, 48kHz 24-bit, patchable
	Playback: 20 channel WAV, 48kHz 24-bit, patchable
USB Audio Interface	Upstream: 24 channel WAV, 48kHz 24-bit, patchable
	Downstream: 24 channel WAV, 48kHz 24-bit, patchable
USB DRIVE PLAY/REC	
2-channel Play/Rec	Recording: WAV 48kHz, 24-bit
	Playback: WAV (16/24-bit), MP3, AIFF; allowed sample rates from 44.1 to 96 kHz
CONTROL INTERFACES	
LAN	1000-BaseTX for remote control
	Dual 1000-BaseTX for Dante audio streaming (M 20XD / M 20RD)
USB host	2 ports
	MIDI interface, WiFi dongle (must be enabled), USB mass storage
POWER	
Input Voltage Range	100-240 VAC, 50/60 Hz
Power Requirements	65 W (M 20X/M 20XD) / 50 W (M 20R/M 20RD)
PHYSICAL	
Weight	7.9 kg (M 20X / M 20XD) / 5.9 kg (M 20R / M 20RD)
Dimensions [D x L x H]	428 x 388 x 131 mm (M 20X / M 20XD) / 285 x 440 x 132.5 mm (M 20R / M 20RD)

## 6. Block Diagram

