



FEATURES

- Premium Performance
- Application Flexibility
- Neodymium Components

APPLICATIONS

Corporate A/V, any small to medium sized live sound reinforcement, performing arts venues, houses of worship, retail, ballrooms, theaters, theme parks.

DESCRIPTION

The newest additions to the celebrated JF Series of 2-way loudspeakers redefine the concept of application flexibility. The integration of premium neodymium components and legendary crossover design in an incredibly adaptable package offers unprecedented utility. All models natively offer a combination of portable features and M10 installation points. Available universal accessories include trim plates that hide handles and provide a connection point for u-brackets, quick release flytrack segments that integrate into any enclosure and adjustable legs for use as a stage monitor. Add revolutionary EAW Focusing in the UX8800 Processor for the pinnacle of performance in any venue.

2-WAY FULL-RANGE LOUDSPEAKER

See *NOTES TABULAR DATA* for details

CONFIGURATION

Subsystem:		
	<i>Transducer</i>	<i>Loading</i>
LF	1x 8 in cone	Vented
HF	1x 1 in exit, 1.75 in voice coil compression driver	Waveguide Plate™

Operating Mode:

	<i>Amplifier Channels</i>	<i>External Signal Processing</i>
	Single-amp LF/HF	High pass filter

PERFORMANCE

Operating Range: 66 Hz to 20 kHz

Nominal Beamwidth:
Conical 100°

Axial Sensitivity (*whole space SPL*):
LF/HF 92 dB 66 Hz to 20 kHz

Input Impedance (*ohms*):
Nominal LF/HF 8
Minimum 6.5 @ 230 Hz

High Pass Filter: High Pass =>60 Hz, 12 dB/octave Butterworth

Accelerated Life Test:
LF/HF 52 V 340 W @ 8 ohm

Calculated Axial Output Limit (*whole space SPL*):
Average LF/HF 118 dB
Peak 124 dB

ORDERING DATA

Description	Part Number
EAW JF8 Black	2034800-00

Optional Accessories	
M10 x 37mm Forged Shoulder Eyebolt	0029818
EAW U-Bracket Adjustable S2 BLK [UBKT-S2]	2035472
EAW ACC Leg Adjustable S (2 Per) [ACC-LGS]	2035438
EAW ACC Flytrack S (2 Per) [ACC-FTS]	2035439
EAW ACC Cover Plate S (2 Per) BLK [ACC-CPS]	2035473

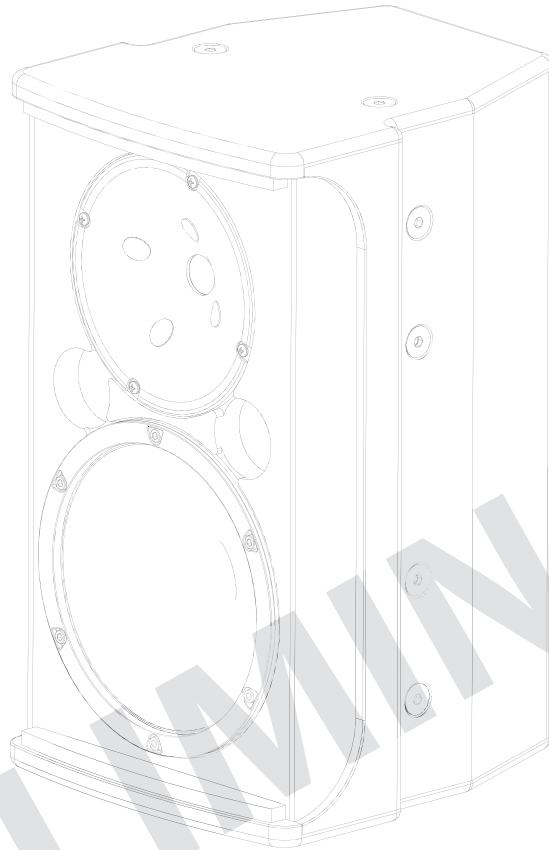

DIMENSIONS

Dimensions	17.46in H × 10.05in W × 11.28in D
	443.5mm H × 255.3mm W × 286.6mm D
Weight	25 lbs / 11.34 kg

NOTE: This drawing has been reduced. Do not scale.



Eastern Acoustic Works • One Main Street • Whitinsville, MA 01588 • tel 800 992 5013 / 508 234 6158 • fax 508 234 8251 • www.eaw.com

EAW products are continually improved. All specifications are therefore subject to change without notice.

Part Number: Preliminary JF8 SPEC



May 2010

PERFORMANCE DATA

See *NOTES GRAPHIC DATA* for details

Frequency Response: Unprocessed

Complete = blue

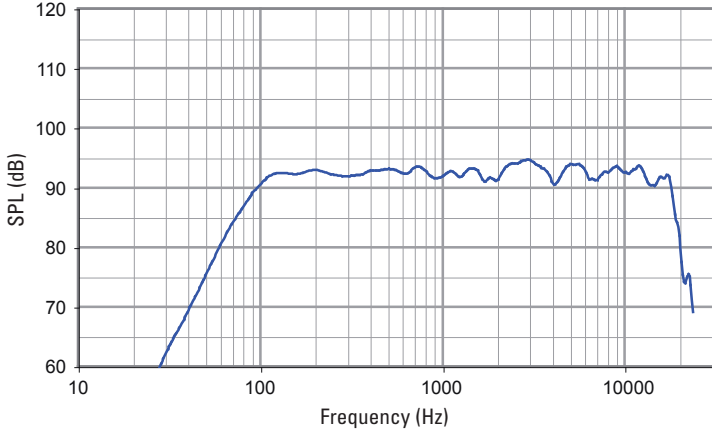

Impedance Magnitude

Complete = blue

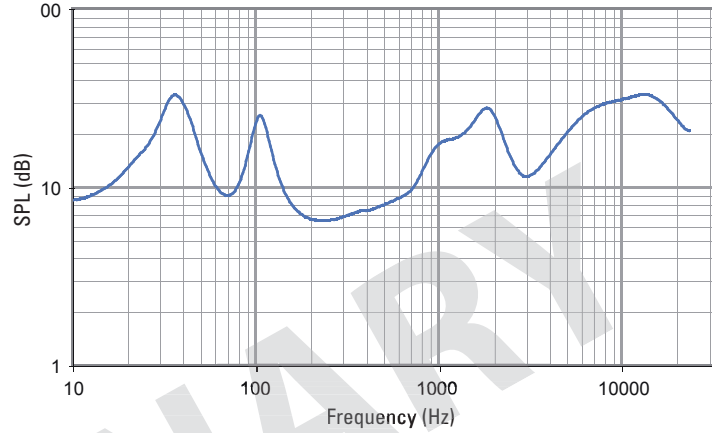

Beamwidth (-6 dB SPL Points)

Horizontal = orange Vertical = black

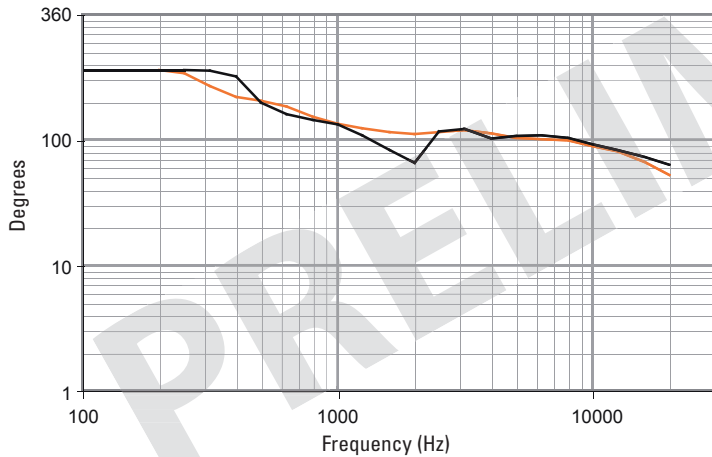

HORIZONTAL POLAR DATA

See *NOTES GRAPHIC DATA* for details

100 Hz
125 Hz
160 Hz
200 Hz

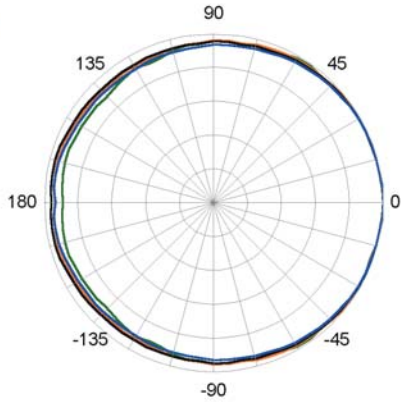

1600 Hz
2000 Hz
2500 Hz
3150 Hz

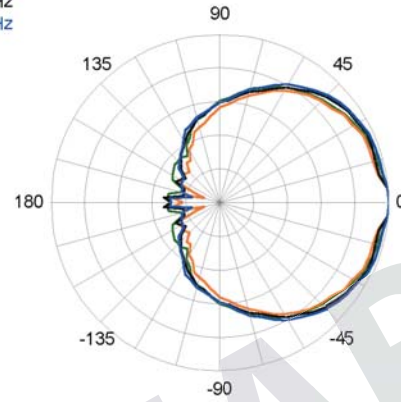

250 Hz
315 Hz
400 Hz
500 Hz

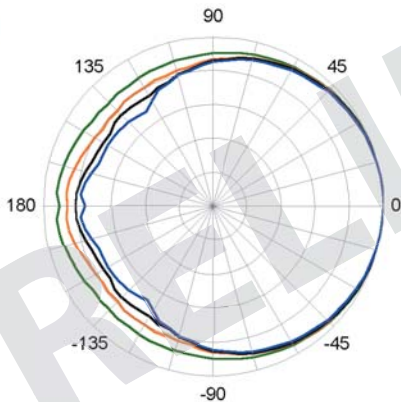

4000 Hz
5000 Hz
6300 Hz
8000 Hz

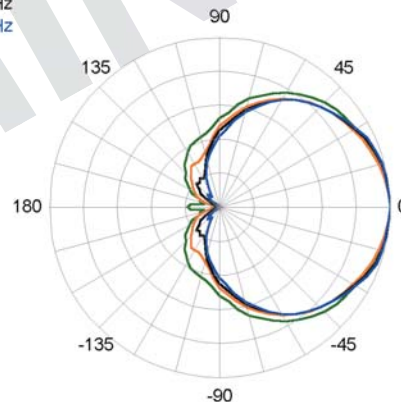

630 Hz
800 Hz
1000 Hz
1250 Hz

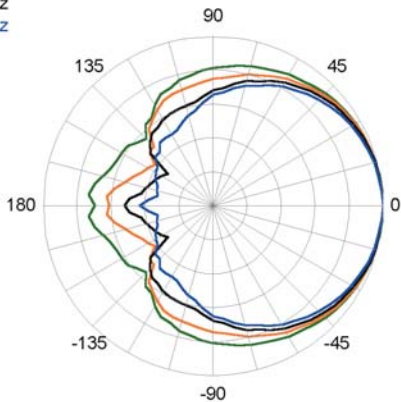

10000 Hz
12500 Hz
16000 Hz

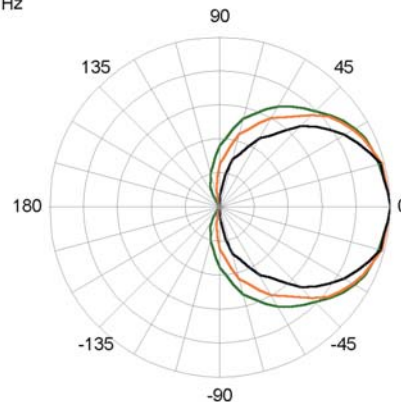

VERTICAL POLAR DATA

See *NOTES GRAPHIC DATA* for details

100 Hz
125 Hz
160 Hz
200 Hz

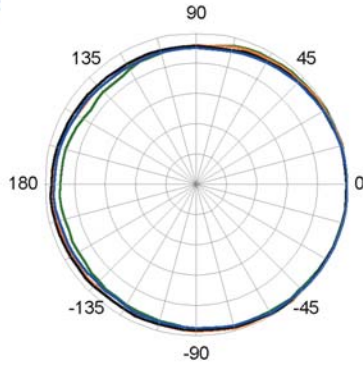

1600 Hz
2000 Hz
2500 Hz
3150 Hz

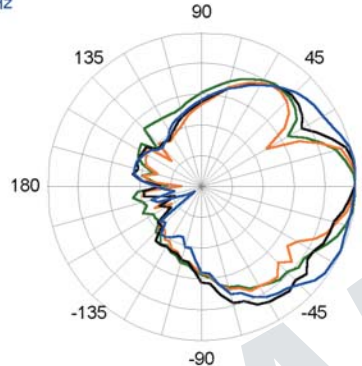

250 Hz
315 Hz
400 Hz
500 Hz

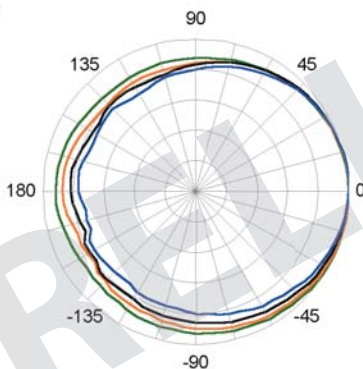

4000 Hz
5000 Hz
6300 Hz
8000 Hz

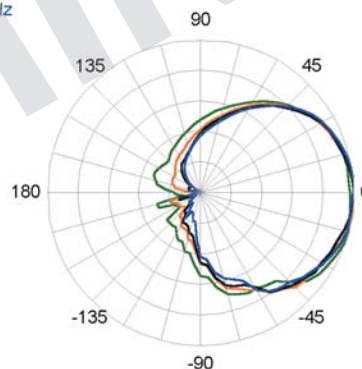

630 Hz
800 Hz
1000 Hz
1250 Hz

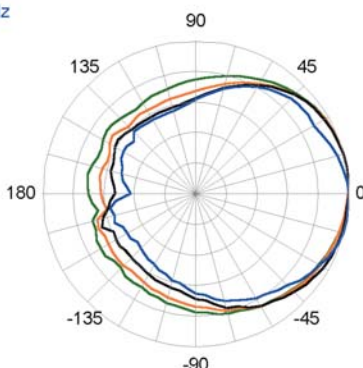

10000 Hz
12500 Hz
16000 Hz

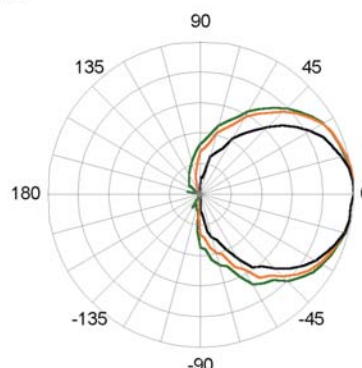

INPUT PANEL

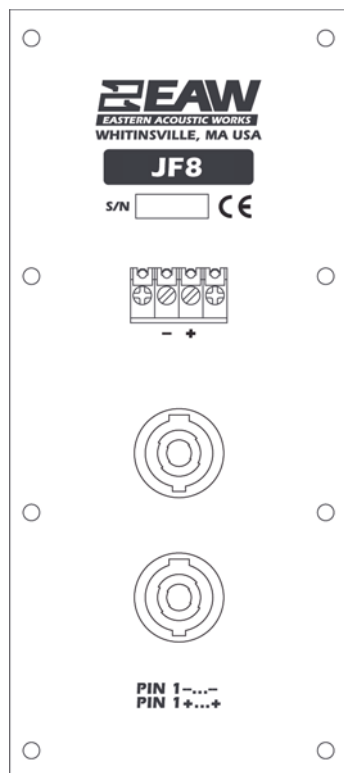

SIGNAL DIAGRAM

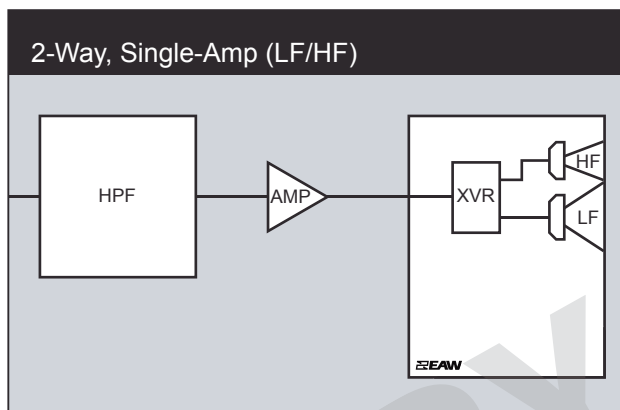

LEGEND

- DSP:** EAW UX8800 Digital Signal Processor –or– Integral Digital Signal Processing for NT products.
- HPF:** High Pass Filter for crossover –or– Recommended High Pass Filter.
- LPF:** Low Pass Filter for crossover.
- LF/MF/HF:** Low Frequency / Mid Frequency / High Frequency.
- AMP:** User Supplied Power Amplifier –or– Integral Amplifier for NT products.
- XVR:** Passive LPFs, HPFs, and EQ integral to the loudspeaker.

NOTES

TABULAR DATA

1. **Measurement/Data Processing Systems:** Primary - FChart: proprietary EAW software; Secondary - Brüel & Kjær 2012.
2. **Microphone Systems:** Earthworks M30; Brüel & Kjær 4133
3. **Measurements:** Dual channel FFT; length: 32 768 samples; sample rate: 48 kHz; logarithmic sine wave sweep.
4. **Measurement System Qualification** (includes all uncertainties): SPL: accuracy +/-0.2 dB @ 1 kHz, precision +/-0.5 dB 20 Hz to 20 kHz, resolution 0.05 dB; Frequency: accuracy +/-1 %, precision +/-0.1 Hz, resolution the larger of 1.5 Hz or 1/48 octave; Time: accuracy +/-10.4 µs, precision +/-0.5 µs, resolution 10.4 µs; Angular: accuracy +/-1°, precision +/-0.5°, resolution 0.5°.
5. **Environment:** Measurements time-windowed and processed to eliminate room effects, approximating an anechoic environment. Data processed as anechoic or fractional space, as noted.
6. **Measurement Distance:** 7.46 m. Acoustic responses represent complex summation of the subsystems at 20 m. SPL is referenced to other distances using the Inverse Square Law.
7. **Enclosure Orientation:** For beamwidth and polar specifications, as shown in Mechanical Specification drawing.
8. **Volts:** Measured rms value of the test signal.
9. **Watts:** Per audio industry practice, "loudspeaker watts" are calculated as voltage squared divided by rated nominal impedance. Thus, these are not True Watt units of energy as defined by International Standard.
10. **SPL:** (Sound Pressure Level) Equivalent to the average level of a signal referenced to 0 dB SPL = 20 microPascals.
11. **Subsystem:** This lists the transducer(s) and their acoustic loading for each passband. Sub = Subwoofer, LF = Low Frequency, MF = Mid Frequency, HF = High Frequency.
12. **Operating Mode:** User selectable configurations. Between system elements, a comma (,) = separate amplifier channels; a slash (/) = single amplifier channel. DSP = Digital Signal Processor. IMPORTANT: To achieve the specified performance, the listed external signal processing must be used with EAW-provided settings.
13. **Operating Range:** Range where the processed Frequency Response stays within -10 dB SPL of the power averaged SPL within this range; measured on the geometric axis. Narrow band dips are excepted.
14. **Nominal Beamwidth:** Design angle for the -6 dB SPL points, referenced to 0 dB SPL as the highest level.
15. **Axial Sensitivity:** Power averaged SPL over the Operating Range with an input voltage that would produce 1 W at the nominal impedance; measured with no external processing on the geometric axis, referenced to 1 m.
16. **Nominal Impedance:** Selected 4, 8, or 16 ohm resistance such that the minimum impedance point is no more than 20% below this resistance over the Operating Range.
17. **Accelerated Life Test:** Maximum test input voltage applied with an EIA-426B defined spectrum; measured with recommended signal processing and Recommended Protection Filter.
18. **Calculated Axial Output Limit:** Highest average and peak SPLs possible during the Accelerated Life Test. The Peak SPL represents the 2:1 (6 dB) crest factor of the Life Test signal.
19. **High Pass Filter:** This helps protect the loudspeaker from excessive input signal levels at frequencies below the Operating Range.

GRAPHIC DATA

1. **Resolution:** To remove insignificant fine details, 1/12 octave cepstral smoothing was applied to acoustic frequency responses and 1/3 octave cepstral smoothing was applied to the beamwidth and impedance data. Other graphs are plotted using raw data.
2. **Frequency Responses:** Variation in acoustic output level with frequency for a constant input signal. Processed: normalized to 0 dB SPL. Unprocessed inputs: 2 V (4 ohm nominal impedance), 2.83 V (8 ohm nominal impedance), or 4 V (16 ohm nominal impedance) referenced to a distance of 1 m.
3. **Processor Response:** The variation in output level with frequency for a constant input signal of 0.775 V = 0 dB reference.
4. **Beamwidth:** Average angle for each 1/3 octave frequency band where, starting from the rear of the loudspeaker, the output first reaches -6 dB SPL referenced to 0 dB SPL as the highest level. This method means the output may drop below -6 dB SPL within the beamwidth angle.
5. **Impedance:** Variation in impedance magnitude, in ohms, with frequency without regard to voltage/current phase. This means the impedance values may not be used to calculate True Watts (see 9 above).
6. **Polar Data:** Horizontal and vertical polar responses for each 1/3 octave frequency band 100 Hz to 16 kHz or Operating Range.