

Panasonic®

Operating Instructions

DLP™ Based Projector **Commercial Use**

Model No. **PT-DZ6710E**

PT-DZ6700E

PT-DW6300E

PT-D6000E

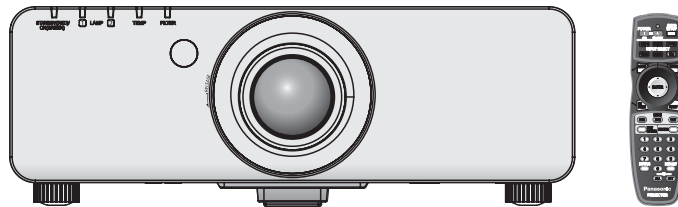

Before operating this product, please read the instructions carefully and save this manual for future use.
The information of these instructions are shared use with multiple models of DZ6710 series, DZ6700 series, DW6300 series and D6000 series.

TQBJ0296

ENGLISH

Important Safety Notice

Dear Panasonic Customer:

This instruction booklet provides all the necessary operating information that you might require. We hope it will help you to get the most out of your new product, and that you will be pleased with your Panasonic DLP™ Based projector. The serial number of your product may be found on its bottom. You should note it in the space provided below and retain this booklet in case service is required.

Model number: **PT-DZ6710E/PT-DZ6700E/PT-DW6300E/PT-D6000E**

Serial number:

WARNING: THIS APPARATUS MUST BE EARTHED.

WARNING: To prevent damage which may result in fire or shock hazard, do not expose this appliance to rain or moisture.

Machine Noise Information Ordinance 3. GSGV, January 18, 1991: The sound pressure level at the operator position is equal or less than 70 dB (A) according to ISO 7779.

WARNING:

1. Remove the plug from the mains socket when this unit is not in use for a prolonged period of time.
2. To prevent electric shock, do not remove cover. No user serviceable parts inside. Refer servicing to qualified service personnel.
3. Do not remove the earthing pin on the mains plug. This apparatus is equipped with a three prong earthing-type mains plug. This plug will only fit an earthing-type mains socket. This is a safety feature. If you are unable to insert the plug into the mains socket, contact an electrician. Do not defeat the purpose of the earthing plug.

CAUTION: To assure continued compliance, follow the attached installation instructions, which includes using the provided power cord and shielded interface cables when connecting to computer or peripheral device. If you use serial port to connect PC for external control of projector, you must use optional RS-232C serial interface cable with ferrite core. Any unauthorized changes or modifications to this equipment will void the user's authority to operate.

Pursuant to at the directive 2004/108/EC, article 9(2)
Panasonic Testing Centre
Panasonic Service Europe, a division of Panasonic Marketing Europe GmbH
Winsberggring 15, 22525 Hamburg, F.R. Germany



Information for Users on Collection and Disposal of Old Equipment and used Batteries

These symbols on the products, packaging, and/or accompanying documents mean that used electrical and electronic products and batteries should not be mixed with general household waste. For proper treatment, recovery and recycling of old products and used batteries, please take them to applicable collection points, in accordance with your national legislation and the Directives 2002/96/EC and 2006/66/EC.

By disposing of these products and batteries correctly, you will help to save valuable resources and prevent any potential negative effects on human health and the environment which could otherwise arise from inappropriate waste handling.



For more information about collection and recycling of old products and batteries, please contact your local municipality, your waste disposal service or the point of sale where you purchased the items. Penalties may be applicable for incorrect disposal of this waste, in accordance with national legislation.

For business users in the European Union

If you wish to discard electrical and electronic equipment, please contact your dealer or supplier for further information.



Information on Disposal in other Countries outside the European Union

These symbols are only valid in the European Union. If you wish to discard these items, please contact your local authorities or dealer and ask for the correct method of disposal.

Note for the battery symbol (bottom two symbol examples):

This symbol might be used in combination with a chemical symbol. In this case it complies with the requirement set by the Directive for the chemical involved.

Important Safety Notice

IMPORTANT: THE MOULDED PLUG (U.K. only)

FOR YOUR SAFETY, PLEASE READ THE FOLLOWING TEXT CAREFULLY.

This appliance is supplied with a moulded three pin mains plug for your safety and convenience. A 13 amp fuse is fitted in this plug. Should the fuse need to be replaced, please ensure that the replacement fuse has a rating of 13 amps and that it is approved by ASTA or BSI to BS1362.

Check for the ASTA mark  or the BSI mark  on the body of the fuse.

If the plug contains a removable fuse cover, you must ensure that it is refitted when the fuse is replaced. If you lose the fuse cover, the plug must not be used until a replacement cover is obtained. A replacement fuse cover can be purchased from an Authorised Service Centre.

If the fitted moulded plug is unsuitable for the mains socket in your home, then the fuse should be removed and the plug cut off and disposed of safely. There is a danger of severe electrical shock if the cut off plug is inserted into any 13 amp socket.

If a new plug is to be fitted, please observe the wiring code as shown below. If in any doubt, please consult a qualified electrician.

WARNING: THIS APPLIANCE MUST BE EARTHED.

IMPORTANT: The wires in this mains lead are coloured in accordance with the following code:

Green - and - Yellow:	Earth
Blue:	Neutral
Brown:	Live

As the colours of the wire in the mains lead of this appliance may not correspond with the coloured markings identifying the terminals in your plug, proceed as follows.

The wire which is coloured GREEN - AND - YELLOW must be connected to the terminal in the plug which is marked with the letter E or by the Earth symbol \perp or coloured GREEN or GREEN - AND - YELLOW.

The wire which is coloured BLUE must be connected to the terminal in the plug which is marked with the letter N or coloured BLACK.

The wire which is coloured BROWN must be connected to the terminal in the plug which is marked with the letter L or coloured RED.

How to replace the fuse: Open the fuse compartment with a screwdriver and replace the fuse.

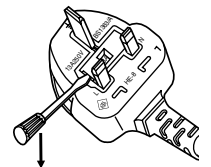

Contents

■ Quick steps

1. Set up your projector
See “Setting up” on page 16.



2. Connect with other devices
See the functional instructions in the CD-ROM that is provided with the projector.



3. Prepare the Remote control
See “Remote control” on page 14.



4. Start projecting
See “Projecting” on page 19.



5. Adjust the image
See “Menu Navigation” on page 24.

Important Information

Important Safety Notice	2
Precautions with regard to safety	6
WARNINGS	6
CAUTIONS	7
Cautions when transporting	9
Cautions when installing	9
Cautions on use	9
Others	10
Security	10
Accessories	11

Preparation

About Your Projector	12
Projector body	12
Remote control	14

Getting Started

Setting up	16
Projection method	16
Removing and attaching the projection lens	17
Mains lead	18

Basic Operation

Projecting	19
Projecting a image	19
Remote control operation	21
Operating range	21
Setting up the image position automatically	21
Switching the input signal	22
Stopping the projection	22
Clearing the screen	22
Changing the picture aspect ratio	22
Displaying the internal test pattern	22
Using an assigned function	23
Displaying the status of the projector	23
Menu Navigation	24
Main menu and Sub-menu	24
Navigating through the menu	27

Maintenance

Monitor Lamp indicators	28
Managing the indicated problems	28
Replacement	30
Replacing the Auto Cleaning Filter (ACF)	30
Replacing the Lamp unit	31
Troubleshooting	33

Appendix

Technical Information	34
List of compatible signals	34
Specifications	36
Dimensions	38
Trademark acknowledgements	38
Index	39

Precautions with regard to safety

WARNINGS

If you notice smoke, strange smells or noise coming from the projector, disconnect the mains plug from the mains socket.

- Do not continue to use the projector in such cases, otherwise fire or electric shocks could result.
- Check that no more smoke is coming out, and then contact an Authorised Service Centre for repairs.
- Do not attempt to repair the projector yourself, as this can be dangerous.

Do not install this projector in a place which is not strong enough to take the full weight of the projector.

- If the installation location is not strong enough, it may fall down or tip over, and severe injury or damage could result.

Installation work (such as ceiling suspension) should only be carried out by a qualified technician.

- If installation is not carried out correctly, there is the danger that injury or electric shocks may occur.
- Do not use other than an authorised ceiling mount bracket.

If foreign objects or water get inside the projector, or if the projector is dropped or the cabinet is broken, disconnect the mains plug from the mains socket.

- Continued use of the projector in this condition may result in fire or electric shocks.
- Contact an Authorised Service Centre for repairs.

The mains socket shall be installed near the equipment and shall be easily accessible.

- Unplug the mains plug from the mains socket immediately when problem occurred.

Do not overload the mains socket.

- If the power supply is overloaded (for example, by using too many adapters), overheating may occur and fire may result.

Never attempt to modify or disassemble the projector.

- High voltages can cause fire or electric shocks.
- For any inspection, adjustment and repair work, please contact an Authorised Service Centre.

Clean the mains plug regularly to prevent it from becoming covered in dust.

- If dust builds up on the mains plug, the resulting humidity can damage the insulation, which could result in fire. Pull the mains plug out from the mains socket and wipe it with a dry cloth.
- If not using the projector for an extended period of time, pull the mains plug out from the mains socket.

Do not handle the mains plug with wet hands.

- Failure to observe this may result in electric shocks.

Insert the mains plug securely into the mains socket.

- Do not use other than the provided mains lead.
- If the plug is not inserted correctly, electric shocks or overheating could result.
- Do not use plugs which are damaged or mains sockets which are coming loose from the wall.

Do not place the projector on top of surfaces which are unstable.

- If the projector is placed on top of a surface which is sloped or unstable, it may fall down or tip over, and injury or damage could result.

Do not place the projector into water or let it become wet.

- Failure to observe this may result in fire or electric shocks.

Do not do anything that might damage the mains lead or the mains plug.

- Do not damage the mains lead, make any modifications to it, place it near any hot objects, bend it excessively, twist it, pull it, place heavy objects on top of it or wrap it into a bundle.
- If the mains lead is used while damaged, electric shocks, short-circuits or fire may result.
- Ask an Authorised Service Centre to carry out any repairs to the mains lead that might be necessary.

Do not place the projector on soft materials such as carpets or sponge mats.

- Doing so may cause the projector to overheat, which can cause burns, fire or damage to the projector.

Do not place liquid containers on top of the projector.

- If water spills onto the projector or gets inside it, fire or electric shocks could result.
- If any water gets inside the projector, contact an Authorised Service Centre.

Do not insert any foreign objects into the projector.

- Do not insert any metal objects or flammable objects into the projector or drop them onto the projector, as doing so can result in fire or electric shocks.

Do not allow the + and - terminals of the batteries to come into contact with metallic objects such as necklaces or hairpins.

- Failure to observe this may cause the batteries to leak, overheat, explode or catch fire.
- Store the batteries in a plastic bag and keep them away from metallic objects.

Precautions with regard to safety

Do not touch the leaked liquid from the batteries.

- If you touch the leaked liquid, it may hurt your skin. Immediately wash away the liquid with water and seek medical advice.
- If you get the leaked liquid in your eye, it may cause blindness or damage. Never rub your eye, and immediately wash away the liquid with water and seek medical advice.

During a thunderstorm, do not touch the projector or the cable.

- Electric shocks can result.

Do not use the projector in a bath or shower.

- Fire or electric shocks can result.

Do not place your skin into the light beam while the projector is being used.

- Strong light is emitted from the projector's lens. If you place directly into this light, it can hurt or damage your skin.

Do not look into the lens while the projector is being used.

- Strong light is emitted from the projector's lens. If you look directly into this light, it can hurt and damage your eyes.

Do not disassemble the lamp unit.

- If the lamp section breaks, it may cause injury.

Do not place your hands or other objects close to the air outlet port.

- Heated air comes out of the air outlet port. Do not place your hands or face, or objects which cannot withstand heat close to this port [allow at least 50 cm (20") of space], otherwise burns or damage could result.

Replacement of the lamp should be carried out by a qualified technician.

- The lamp has high internal pressure. If improperly handled, explosion might result.
- The lamp can easily become damaged if struck against hard objects or dropped, and injury or malfunctions may result.

When replacing the lamp, allow it to cool for at least one hour before handling it.

- The lamp cover gets very hot, and touching it can cause burns.

Before replacing the lamp, be sure to disconnect the mains plug from the mains socket.

- Electric shocks or explosions can result if this is not done.

Do not allow infants or pets to touch the remote control unit.

- Keep the remote control unit out of the reach of infants and pets after using it.

After removing the battery from remote control unit, keep it away from the reach of children.

- The battery can cause death by suffocation if swallowed.
- If the battery is swallowed, seek medical advice immediately.

Insulate the battery using tape or similar before disposal.

- If the battery comes into contact with metallic objects or other batteries, it may catch fire or explode.

When installing to a ceiling, be sure to use the accessory wire (install in a different location to the ceiling mount bracket) and the eye bolts as an extra preventative measure to stop the projector from falling down.

- If the projector is not secure enough, accidents may result.

Do not place sets directly on top of each other.

- If this is not observed, accidents may result.

Do not use the projector while the projection lens cover is still attached to the projection lens.

- If this is not observed, fire may occur.

CAUTIONS

Do not cover the air inlet port or the air outlet port.

- Doing so may cause the projector to overheat, which can cause fire or damage to the projector.
- Do not place the projector in narrow, badly ventilated places such as closets or bookshelves.
- Do not place the projector on cloth or papers, as these materials could be drawn into the air inlet port.

Do not set up the projector in humid or dusty places or in places where the projector may come into contact with oily smoke or steam.

- Using the projector under such conditions may result in fire, electric shocks or plastic deterioration. The plastic deterioration may cause the falling down of the projector which is mounted on the ceiling.

Precautions with regard to safety

Do not set up the projector in a high temperature environment, such as near a heater or in direct sunlight.

- Failure to observe this may result in fire, malfunction or plastic deterioration.

Do not set up the projector outdoors.

- The projector is designed for indoor use only.

When disconnecting the mains lead, hold the plug, not the lead.

- If the mains lead itself is pulled, the lead will become damaged, and fire, short-circuits or serious electric shocks may result.

Always disconnect all cables before moving the projector.

- Moving the projector with cables still attached can damage the cables, which could cause fire or electric shocks to occur.

Do not place any heavy objects on top of the projector.

- Failure to observe this may cause the projector to become unbalanced and fall, which could result in damage or injury.

Do not short-circuit, heat or disassemble the batteries or place them into water or fire.

- Failure to observe this may cause the batteries to overheat, leak, explode or catch fire, and burns or other injury may result.

When inserting the batteries, make sure the polarities (+ and -) are correct.

- If the batteries are inserted incorrectly, they may explode or leak, and fire, injury or contamination of the battery compartment and surrounding area may result.

Use only the specified batteries.

- If incorrect or different kind of batteries are used, they may explode or leak, and fire, injury or contamination of the battery compartment and surrounding area may result.

Do not mix old and new batteries.

- If the batteries are used mixing old and new, they may explode or leak, and fire, injury or contamination of the battery compartment and surrounding area may result.

Remove the used batteries from the remote control promptly.

- If you leave used batteries in the remote control for an extended period of time, it may cause liquid leaking, abnormal internal temperature rising or explosion.

If not using the projector for an extended period of time, disconnect the mains plug from the mains socket and remove the batteries from the remote control.

- If dust builds up on the mains plug, the resulting humidity may damage the insulation, which could result in fire.
- Keeping or leaving the remote control with batteries inside may cause insulation deterioration, electrical leakage or explosion which could result in fire.

Do not use the old lamp unit.

- The lamp section may break.

Do not put your weight on this projector.

- You could fall or the projector could break, and injury may result.
- Be especially careful not to let young children stand or sit on the projector.

Disconnect the mains plug from the mains socket as a safety precaution before carrying out any cleaning.

- Electric shocks can result if this is not done.

If the lamp has broken, ventilate the room immediately. Do not touch or bring your face close to the broken pieces.

- Failure to observe this may cause the user to absorb the gas which was released when the lamp broke and which contains nearly the same amount of mercury as fluorescent lamps, and the broken pieces may cause injury.
- If you believe that you have absorbed the gas or that the gas has got into your eyes or mouth, seek medical advice immediately.
- Ask your dealer about the replacement of the lamp unit and check the inside of the projector.

Ask an Authorised Service Centre to clean inside the projector at least once a year.

- If dust is left to build up inside the projector without being cleaned out, it can result in fire or problems with operation.
- It is a good idea to clean the inside of the projector before the season for humid weather arrives. Ask your nearest Authorised Service Centre to clean the projector when required. Please discuss with the Authorised Service Centre regarding cleaning costs.

Do not use chemical treated wipes when cleaning.

- Using chemical treated wipes may result in plastic distortion or deterioration.

Precautions with regard to safety

Do not reach for the openings beside the optical lens, during horizontal or vertical movements of the lens.

- Failure to observe this may cause injury.

Replacement of the lamp unit should only be carried out after it has completely cooled off.

- Failure to observe this may cause burns.

We are constantly making efforts to preserve and maintain a clean environment. Please take non repairable units back to your dealer or a recycling company.

Cautions when transporting

Do not subject the projector to excessive vibration or shocks.

- The projector lens need to be handled with care.
- Cover the lens with the lens cover when transporting the projector.

When transporting the projector, hold the body at the bottom securely.

- Do not hold the adjuster legs or the top cover to move the projector, as this may damage the projector.

Be sure to always remove the lens during transport.

- The projection lens is susceptible to vibrations and impacts.

Cautions when installing

Avoid setting up in places which are subject to vibration or shocks.

- The internal parts can be damaged, which may cause malfunctions or accidents.

Avoid setting up in places which are subject to sudden temperature changes, such as near an air conditioner or lighting equipment.

- The life of the lamp may be shortened or the projector may be turned off. See "TEMP indicator" on page 28.

Do not set up the projector near high-voltage power lines or near motors.

- The projector may be subject to electromagnetic interference.

If installing the projector to the ceiling, ask a qualified technician to carry out all installation work.

- You will need to purchase the separate installation kit (Model No. ET-PKF100H, ET-PKF100S). Furthermore, all installation work is should only be carried out by a qualified technician.

If using this projector at high elevations 1 400 - 2 700 m (4 593 - 8 858 ft) sea level, set the HIGH ALTITUDE MODE to ON.

- Failure to observe this may result in malfunctions or the life of the lamp or the other components may be shortened.

Be sure to install the projection lens cover after installing the projection lens.

- If this not done, dust will collect inside the projector and problems with the projector will result.

Cautions on use

In order to get the best picture quality

- Draw curtains or blinds over any windows and turn off any lights near the screen to prevent outside light or light from indoor lamps from shining onto the screen.
- In rare cases, wafture can occur on the screen affected by the warm air from the exhaust port depending on the environment. Make sure that there is no equipment in front of the set which will recirculate the exhaust air from the set or other nearby equipment.

Do not touch the surfaces of the lens or the front glass with your bare hands.

- If the surface of the lens becomes dirty from fingerprints or anything else, this will be magnified and projected onto the screen. Moreover, when not using the projector, close the front panel cover.

Precautions with regard to safety

The projector has a high pressure mercury lamp and that is characterised as follows.

- The brightness of the lamp depends on the duration of use.
- The lamp may explode or shorten the lamp life by shocks or chipping damage.
- The lamp may explode only occasionally after using the projector.
- The lamp may explode if using the projector after the instructed lamp replacement timing.
- When the lamp exploded, it emits internal smoke-like gas.
- The lamp life is depends on individual lamp characteristics, usage condition and the installation environment. Especially the consecutive use of the projector for more than 22 hours, or the frequent switching on or off may greatly affect on the lamp life.
- Provide a lamp for replacement in advance.

Optical components

- If you use the projector consecutively 22 hours every day, the optical components may need to be replaced in less than 1 year.

Do not use projectors with the adjustable feet or projection lens cover removed.

- If this is not observed, the sets may not operate correctly or accidents may result.

DLP chips

- The DLP chips are made using extremely high-precision technology. Note that in rare cases, pixels may be missing or always lit, but this is not a malfunction.

Others

Disposal

- When disposing of the product, contact your nearest municipality or dealer to confirm the correct procedure for disposal.

Connection to external device

- When connecting the projector to a computer or external device, use the power cord supplied with the corresponding device and a commercially available shielded interface cable.

Security

Take the safety measures for use of the projector that should cover the following envisioned incidents.





- The leakage of your personal registered information.
- Dishonest operation by an untrusted third party.
- Locking out or prevent anyone else from using the projector by an untrusted third party.

Security instruction

- The connecting network must be secured by firewall or others.
- Change your password regularly.
- Do not use password too simple to guess.
- The Authorised Service Centre will never ask you for the password.
- Do not share your password with anyone else.
- Password the projector and restrict access to authorized users only.

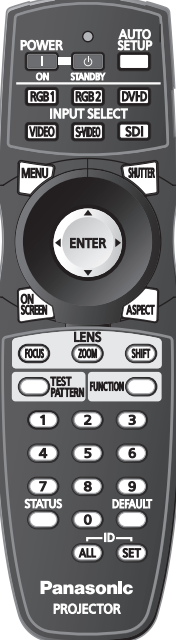
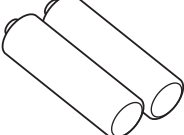
Accessories

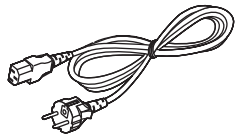
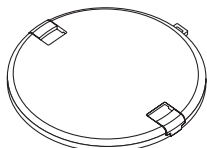
Make sure the following accessories are provided with your projector.

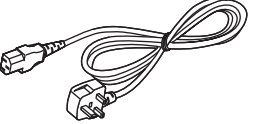
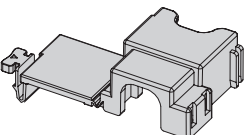
<p>Remote control (x1) N2QAYB000371</p> 	<p>AA batteries for remote control (x2)</p> 	<p>Safety cable TTRA0214 Attachment screw (x1) Safety cable (x1)</p> 	<p>Mains lead (x1) K2CM3FZ00003</p> 
<p>Projector lens cover (x1) TKKL5244-1</p> 	<p>CD-ROM (x1) TQBH9013</p> 	<p>Mains lead (x1) K2CT3FZ00003</p> 	
<p>Power cord secure lock (x1) TTRA0183</p> 			

* The protectors for enclosed products, such as a plug cover or foam cartons, must be treated properly.

* Contact to an Authorised Service Centre for lost accessories.

About Your Projector

Projector body

Top, front and bottom view

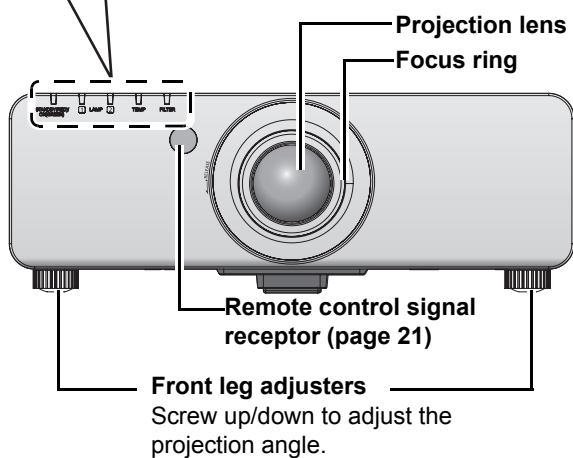
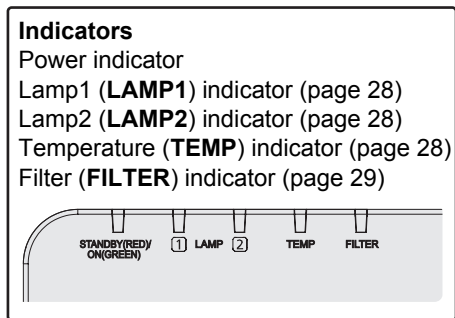

Burglar hook port
 Attach a commercial burglar prevention cable.

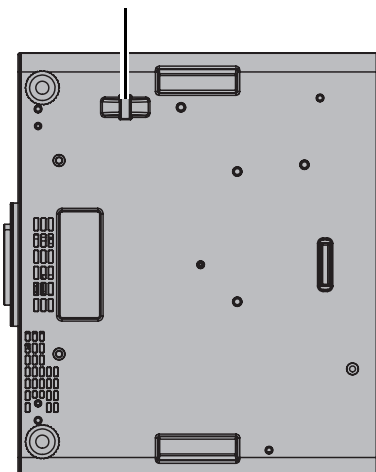

Lamp unit compartment (page 30)

Air exhaust port

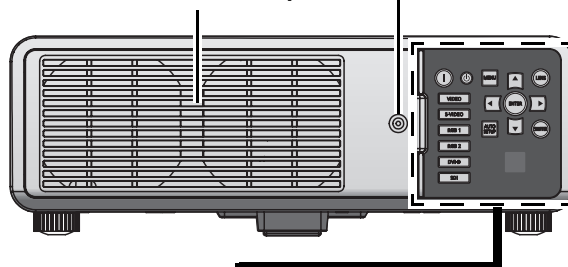

POWER ON button
 Starts the projection while in the standby mode. (page 19)

POWER STANDBY button
 Returns to the standby mode. (page 20)

MENU button
 Displays and clears the main menu, and returns to the previous menu when the menu is displayed. (page 27)

LENS button
 This button is used together with ▲ ▼ ◀ ▶ to adjust focus, zoom and shift by the projection lens. (page 19)

Input select buttons
 These buttons select the **RGB1, RGB2, DVI-D, VIDEO, S-VIDEO** and **SDI** (PT-DZ6710E only) terminals. (page 19)

Navigation and ENTER buttons
 Navigate through the menu items with ▲ ▼ ◀ ▶, and activate them with the **ENTER** button. (page 27)

AUTO SETUP button
 Pressing this button while projecting an image automatically corrects the picture positioning on the screen. While the auto setup feature is active, a message **"PROGRESS"** appears on the screen. (page 21)

Remote control signal receptor (page 21)

SHUTTER button
 Pressing this button toggles the projector's internal mechanical shutter to black out the projector. (page 22)

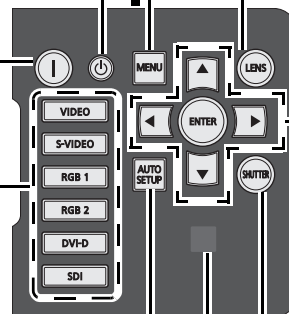

NOTE:

- Do not cover the ventilation openings or place anything within 50 cm (20") of them as this may cause damage or injury.
- While the projector is not in use, keep the projector lens cover attached to protect the lens.

Side views

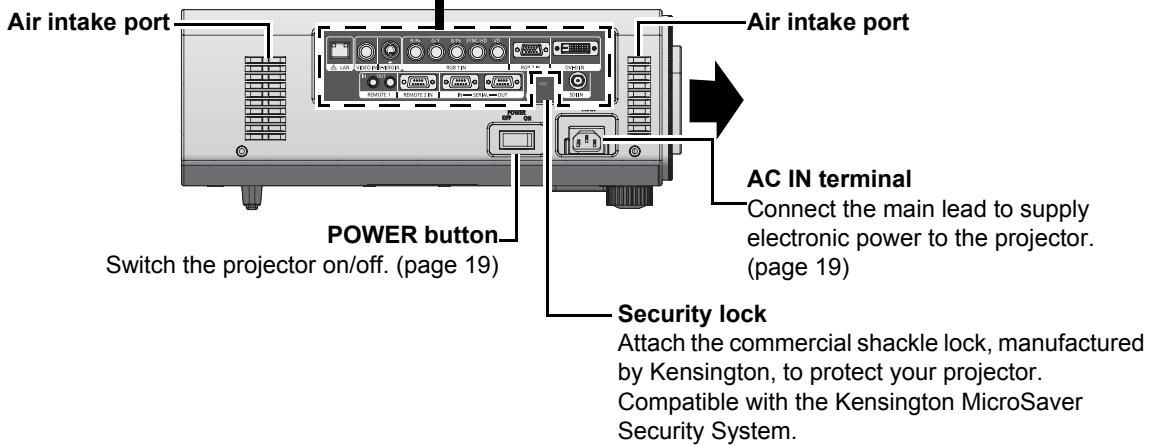
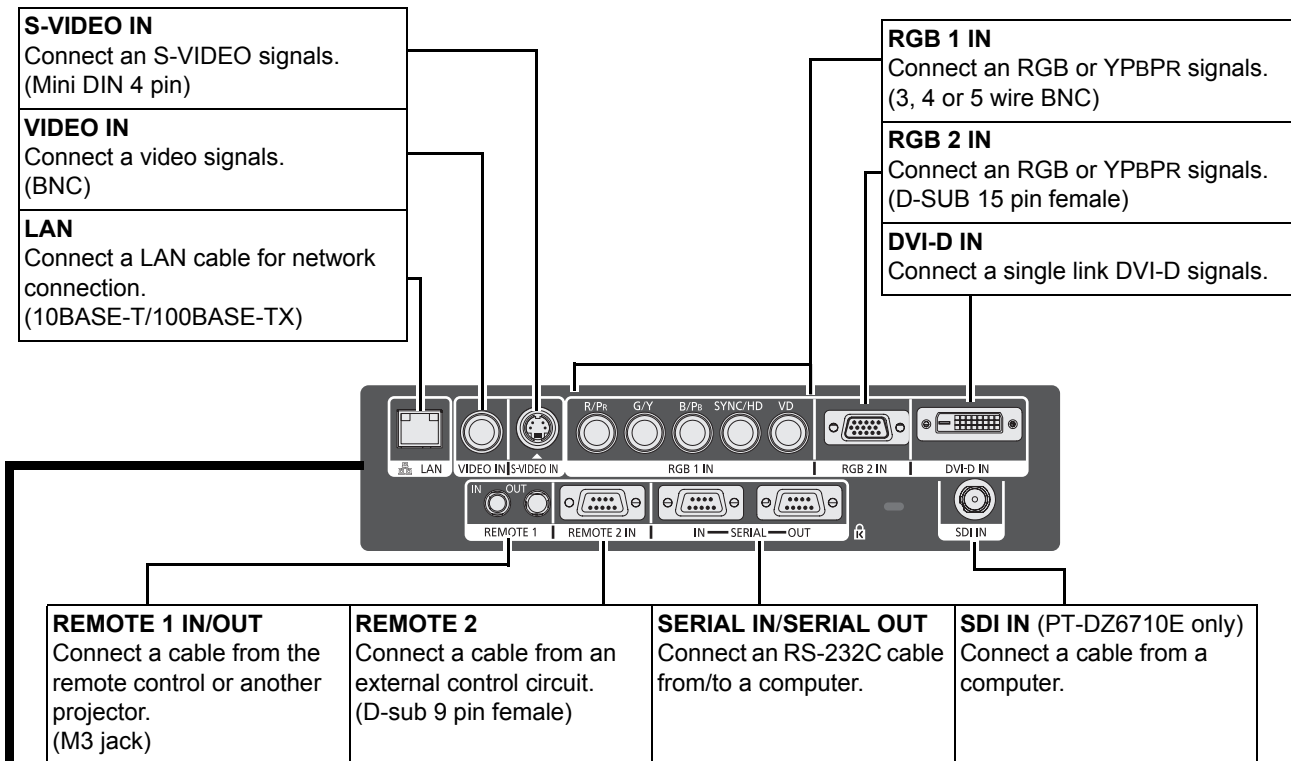

Auto Cleaning Filter (ACF) compartment (page 31)

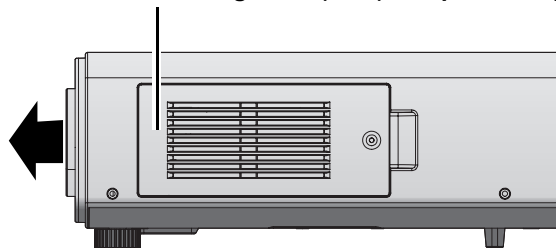







NOTE:

- Switch on the **POWER** button of the projector body that is located near the terminals before using the control buttons.
- Do not cover the ventilation openings or place anything within 50 cm (20") of them as this may cause damage or injury.

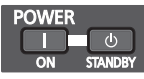



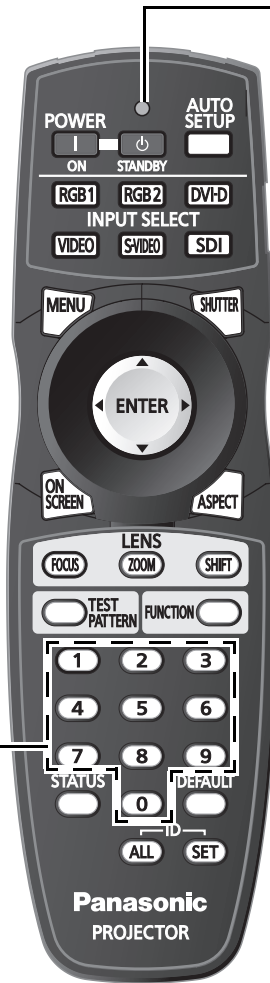

About Your Projector

Remote control

Preparation

POWER ON and POWER STANDBY buttons
<p>POWER ON: Starts the projection while in the standby mode.</p> <p>POWER STANDBY: Returns to the standby mode. (page 19)</p> 
INPUT SELECT buttons
<p>These buttons select the RGB1, RGB2, DVI-D, VIDEO, S-VIDEO and SDI terminals. (page 22)</p> 
MENU buttons
<p>Displays and clears the main menu, and returns to the previous menu when the menu is displayed. (page 27)</p> 
ON SCREEN button
<p>Displays and clears the on screen indications. (page 22)</p> 
TEST PATTERN button
<p>Displays the test pattern. (page 22)</p> 
Numeric (0 - 9) buttons
<p>Enter ID number of the remote control, adjustment values of menu items and by service personnel. (page 15)</p>
STATUS button
<p>Displays projector information. (page 23)</p> 
Navigation and ENTER buttons
<p>Navigate through the menu items with ▲ ▼ ◀ ▶, and activate them with the ENTER button. (page 27)</p> 



Remote control indicator
Flashes by pressing any buttons. (page 21)
AUTO SETUP
<p>Pressing this button while projecting an image automatically corrects the picture positioning on the screen. While the auto setup feature is active, a message "PROGRESS" appears on the screen. (page 21)</p> 
SHUTTER button
<p>Pressing this button toggles the projector's internal mechanical shutter to black out the projector. (page 22)</p> 
ASPECT button
<p>Switches the image aspect ratio. (page 22)</p> 
LENS buttons
<p>These buttons are used together with ▲ ▼ ◀ ▶ to adjust focus, zoom and shift by the projection lens. (page 19)</p> 
FUNCTION button
<p>Assign the frequently use functions from options for shortcut. (page 23)</p> 
DEFAULT button
<p>Restores the default factory setting. (page 23)</p> 
ID buttons
<p>ALL: Makes the remote control available to control any ID projectors.</p> <p>SET: Specifies the ID of the remote control. (page 15)</p> 

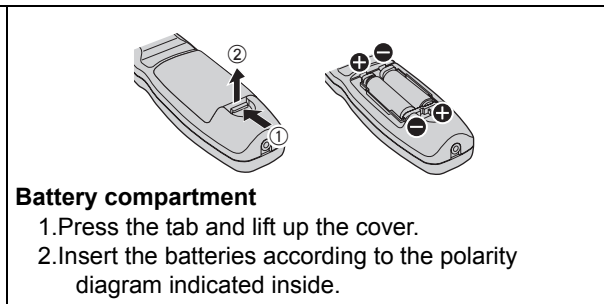
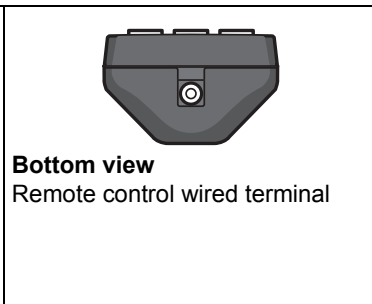
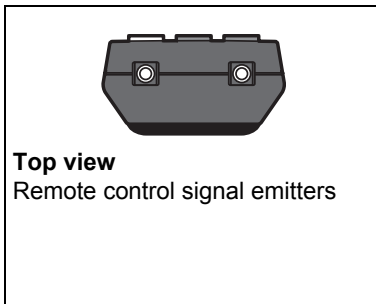

NOTE:

- Switch on the **POWER** button of the projector body that is located near the terminals before using the remote control.
- Do not drop the remote control.
- Avoid contact with liquids or moisture.
- Use manganese batteries or alkaline batteries with the remote control.
- Do not attempt to modify or disassemble the remote control. Contact an Authorised Service Centre for repairs.
- Do not keep pressing the remote control buttons as this may shorten battery life.
- See "Remote control operation" on page 21.

Setting projector ID number to remote control

Each projector can be assigned a unique 2 digits ID number, and the remote control 2 digits ID number must be set to match the intended projector. The default setting of the projector ID is **ALL**. Set the ID of the projector in advance from the menu items.

1. Press the **ID SET** button.
 - Displays the projector ID number on the screen.
2. Within 5 seconds, enter the same number of the required projector by pressing the numeric buttons.
 - ID number range: 01 - 64

NOTE:

- Do not press the **ID SET** button accidentally or carelessly because the ID number on the remote control can be set even when no projector is around.
- If you do not enter the 2 digits ID number within 5 seconds after the **ID SET** button has been pressed, the ID will remain at the number that was set before the **ID SET** button was pressed.
- Your specified ID will be erased if the batteries of the remote control are left exhausted. When the batteries are replaced, set the same ID number again.

Using a wired remote control

When multiple projectors are connected as part of the system, connect to units with a M3 stereo mini jack commercial cable to simultaneously control multiple main units with a single remote control through the **REMOTE 1 IN/OUT** terminal. It is effective to use the wired remote control in the environment in which an obstacle stands in the light path or where devices are susceptible to outside light.

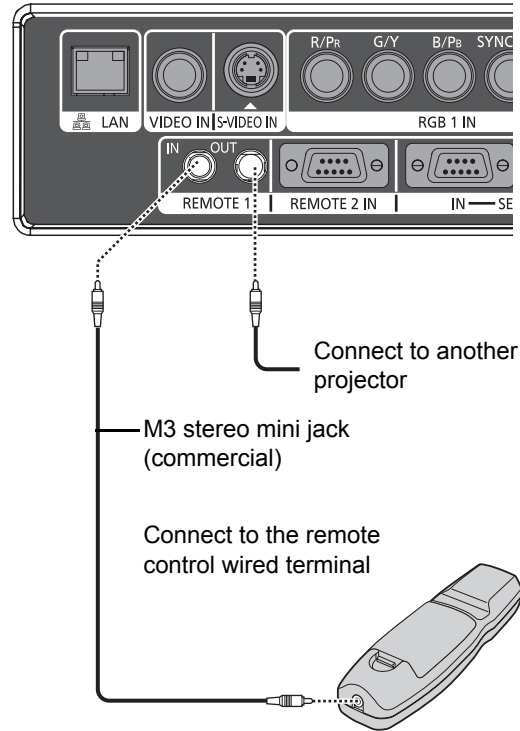

NOTE:

- Use 2 core shielded cable of length of 15 m or less. If the length of the cable exceeds 15 m (49'2"), the shielding of the cable may not be sufficient and the remote control may not work.

Setting up

Projection method

You can use the projector with any of the following 4 projection methods. To set the desired method in the projector,

■ Setting on a desk/floor and projecting from front

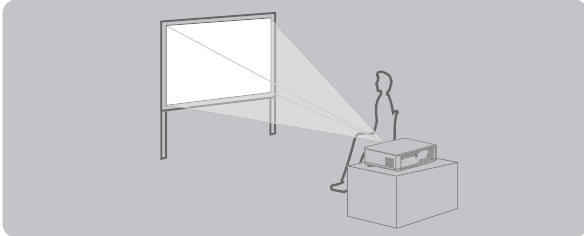

INSTALLATION: FRONT/FLOOR
COOLING CONDITION: FLOOR SETTING

■ Setting on a desk/floor and projecting from rear

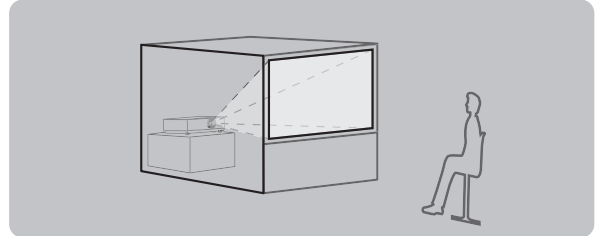

INSTALLATION: REAR/FLOOR
COOLING CONDITION: FLOOR SETTING

■ Mounting on the ceiling and projecting from front

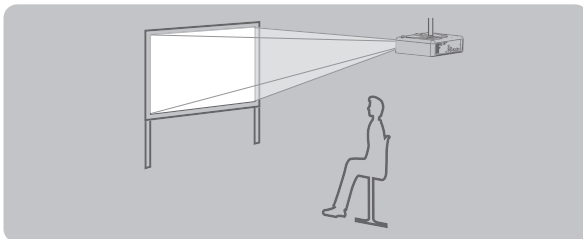

INSTALLATION: FRONT/CEILING
COOLING CONDITION: CEILING SETTING

■ Mounting on the ceiling and projecting from rear

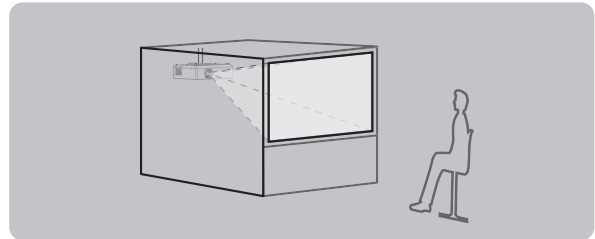

INSTALLATION: REAR/CEILING
COOLING CONDITION: CEILING SETTING

NOTE:

- A translucent screen is required for rear projection.
- See more detailed setting up instructions, **INSTALLATION** and **COOLING CONDITION** in **PROJECTOR SETUP** menu on the functional instructions in the CD that is provided with the projector.
- Do not place or use a projector on top of another projector.
- Do not cover the ventilation openings or place anything within 50 cm (20") of them as this may cause damage or injury.

Removing and attaching the projection lens

Removing the projection lens from the projector

1. Switch off the **POWER** button on the projector.
2. Rotate the lens cover counterclockwise and remove.

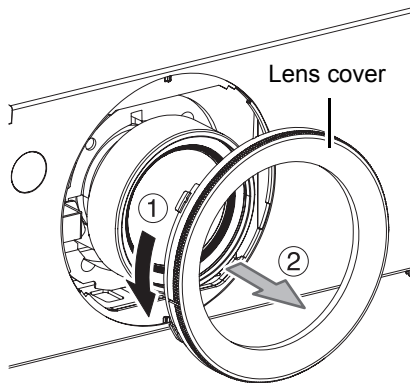

3. While pressing the lens release button, rotate the projection lens counterclockwise, and remove the projection lens.

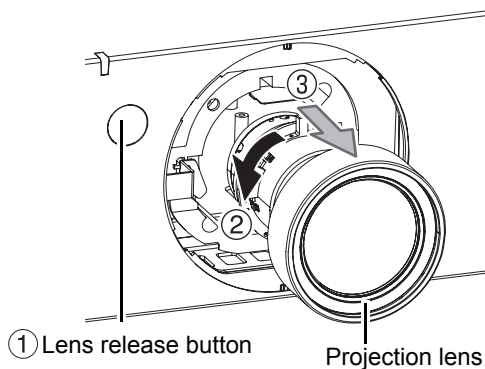

NOTE:

- Do not touch the lens signal contact. Dust or dirt may cause defective contact.
- Do not touch the surface of the projection lens with your bare hands.
- Store the replaced lens where it will be free from vibration and impact.

Attaching the projection lens to the projector

1. Switch off the **POWER** button on the projector.
 - When the lens cover is attached, rotate counterclockwise and remove.
2. Align the guide of the projection lens with the guide groove in the projector, and then insert the lens.

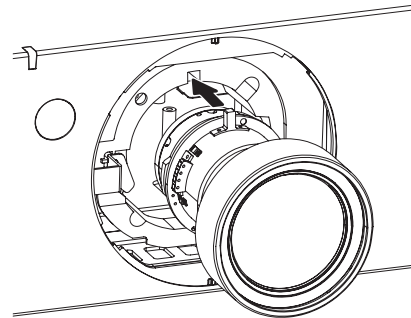

3. Rotate the projection lens clockwise until it clicks into place.

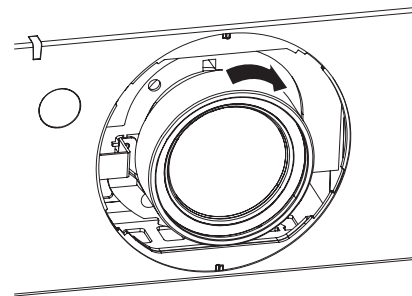

4. Place the lens cover back to the projector, and rotate clockwise to attach.

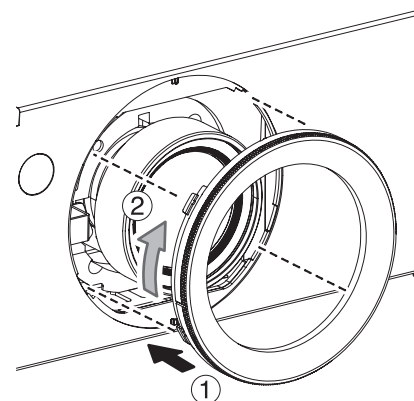

NOTE:

- Make sure the projection lens is attached securely by rotating the projection lens counterclockwise.

Mains lead

Connecting

1. Make sure the shape of the mains plug and the **AC IN** terminal on the back of the projector match, then push the plug all the way in.

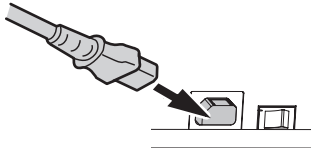

2. Align the side of the power cord secure lock with the side guide rail of the **AC IN** terminal of the projector and slide it in.

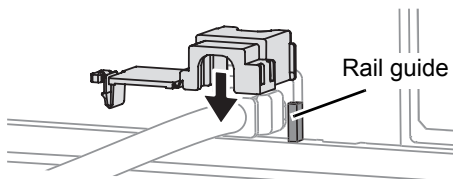

3. Place the latch to the latch catcher and press until it clicks.

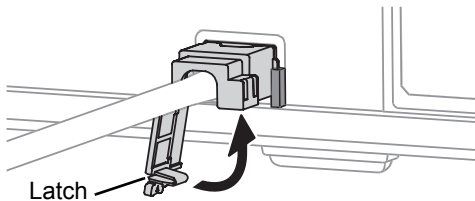

4. Connect the mains lead to a mains socket.

Disconnecting

1. Unplug the mains lead from the mains socket.
2. Depress the latch and slide the cover off.

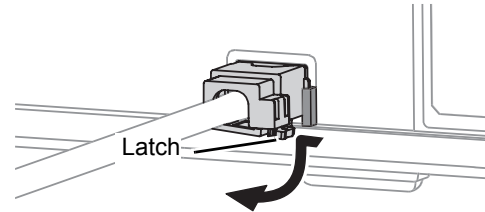

3. Slide the power cord secure lock up along the side guide rail and remove.

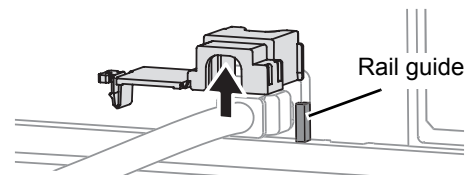

4. Hold the plug and unplug the mains lead from the **AC IN** terminal on the back of the projector.
 - Power indicator lights in orange if the internal cooling fan is still operating by internal power supply.

NOTE:

- Do not use other than the provided mains lead.
- Ensure all the input devices are connected and turned off before connecting the mains lead.
- Do not force the connector as this may damage the projector and/or the mains lead.
- Dirt or dust build-up around plugs may cause fire or electrical hazards.
- Switch off the power to the projector when not in use.
- If the projector is switched on again while the internal cooling fan is still operating by the internal power supply, it may take a while to start the projection.

Projecting

Projecting a image

Switching on the projector

When using an optional lens, install a projection lens before switch on the projector.

1. Connect the supplied mains lead (220 - 240 V AC, 50 Hz/60 Hz) to the **AC IN** terminal.
2. Remove the projection lens cover from the lens.
3. Switch the **POWER** switch on that is on the side of the projector.
 - The power indicator lamp on the projector will flash in red. After a short period, the indicator will illuminate and the projector will enter standby mode.

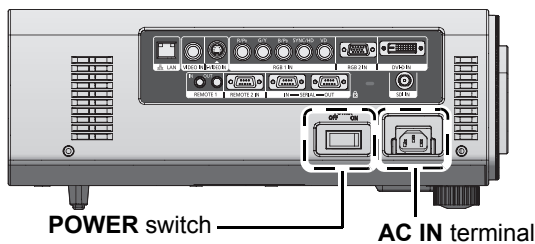

4. Press the **POWER ON** button
 - The power indicator lamp illuminates in green and soon the image is projected on the screen.

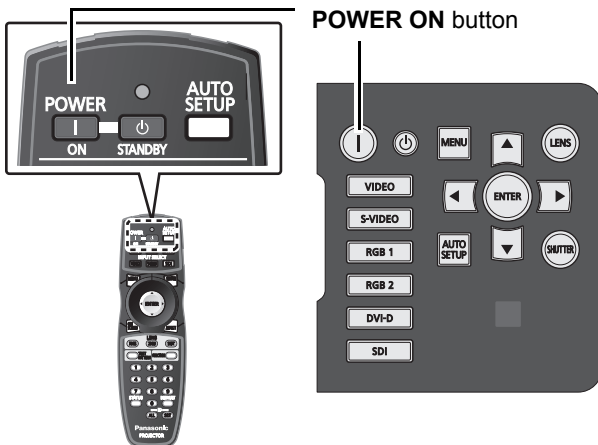

NOTE:

- If the projector is powered up at about 0 °C (32 °F), a warm-up period of approximately 5 minutes may be necessary to start projection. The temperature monitor (**TEMP**) lamp lights up during the warm-up period. When the warm-up is completed, the temperature monitor (**TEMP**) lamp turns off and the image is projected on the screen.
- If the temperature of the operating environment is low and warm-up takes more than 5 minutes, the projector will judge that a problem has occurred and the power will be turned off automatically. If this happens, increase the temperature around the projector so that it is 0 °C (32 °F) or higher, and then turn on the **POWER** switch and press the **POWER ON** button again.

Making adjustment and selection

It is recommended that the projector be allowed to warm up for at least 30 minutes before any adjustments are made to the focus.

1. Roughly adjust the focus of the lens.
2. Select and set the projection scheme of **INSTALLATION** setting in **PROJECTOR SETUP** menu.
3. Select the input signal by pressing the **INPUT SELECT** buttons.
4. Adjust the vertical tilt of the projector with the front leg adjusters.
5. Adjust the shift position of the projection.
 - If the input signal is RGB signal, additionally press the **AUTO SETUP** button to adjust the position of the image.
6. Zoom the lens so the image fills the screen.
7. Readjust the focus.
8. Readjust the zoom so that the image size fits in the screen.

Adjusting focus, zoom and shift

Control buttons of the projector	Pressing the LENS button changes the setup screen in order of FOCUS , ZOOM and SHIFT . Press ▲ ▼ ◀ ▶ to adjust.
Remote control buttons	Press FOCUS , ZOOM or SHIFT button to display the setup screen. Press ▲ ▼ ◀ ▶ to adjust.

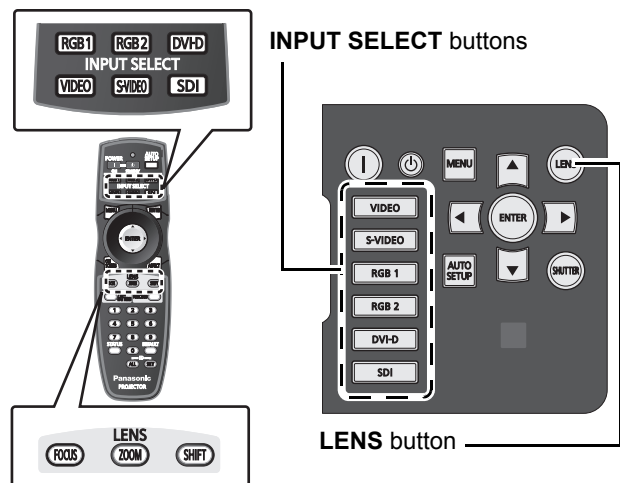

CAUTION:

- Be careful not to catch your fingers between the lens and shroud when shifting the lens.

NOTE:

- The setup screen will be displayed with the optional fixed lens though, it will not be functioning.
- Pressing **▲ ▼ ◀ ▶** for 3 seconds or more, performance the adjustment faster.

Projecting

Switching off the projector

1. Press the **POWER STANDBY** button.
 - The confirmation screen will be displayed.

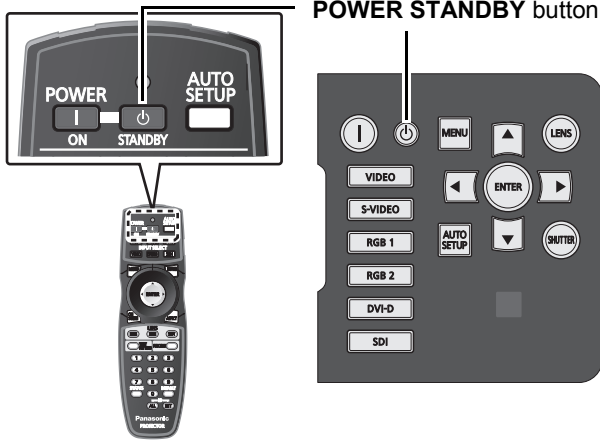

2. Select **OK** and press the **ENTER** button, or press the **POWER STANDBY** button again.
 - The projection of the image stops, and the power indicator of the projector lights up orange. The cooling fan keeps running.
3. When the power indicator of the projector turns to red, switch the **POWER** switch to **OFF**.
 - When the power indicator of the projector turns to red, the cooling fan stops.
 - While the cooling fan is still running, never turn off the **POWER** switch, nor unplug the mains lead from the mains socket.

NOTE:

- In the cooling state after the power is turned off, the lamp will not light up even if the power is turned on. To light up the lamp, turn on the power supply again when the lamp has been cooled sufficiently. Failure to observe this may shorten the lamp life.

Direct power off function

The power supplied internally causes the cooling fan to continue operating and cool off in the event that the power has failed or even after the mains lead is accidentally disconnected immediately after the power has been turned off.

NOTE:

- When the lamp has been cooled by the direct power off function, it sometimes takes longer than usual for the lamp to light up again.
- While the cooling fan is operating, do not place the projector inside a box or bag.

Lens home position

1. Press and hold the **LENS** button of the control button on the projector or **SHIFT** button of the remote control for 3 seconds or more.
 - The **HOME POSITION** setup screen will be displayed for 5 seconds.
2. Press the **ENTER** button before the setup screen disappeared.
 - While the lens returning to the home position, a message "PROGRESS" appears on the screen.

NOTE:

- The home position for the projection lens is the lens position when the lens is being replaced or when the projector is being stored away, and it is not the optical centre of the screen.

Adjustment range after lens position (optical shift)

Do not move the lens beyond the bounds of the shift range as this may cause a change in the focus. This limitation is to protect the parts of the projector. Using the standard projection position as the reference, the optical axis shift function makes it possible to adjust the projection position in the ranges shown in the figures below.

PT-DZ6710E/PT-DZ6700E/PT-D6000E

Standard projection position

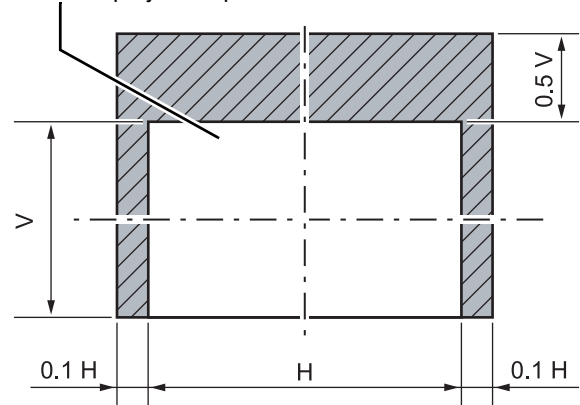

PT-DW6300E

Standard projection position

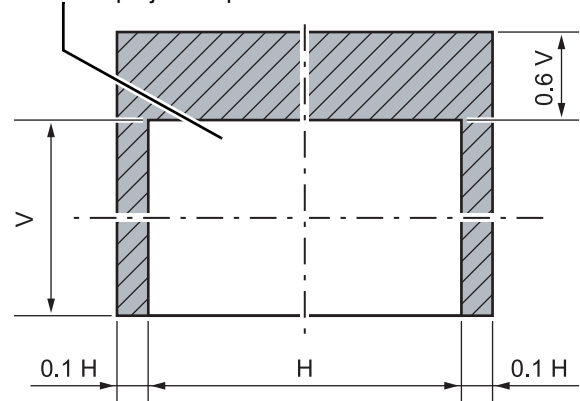

Remote control operation

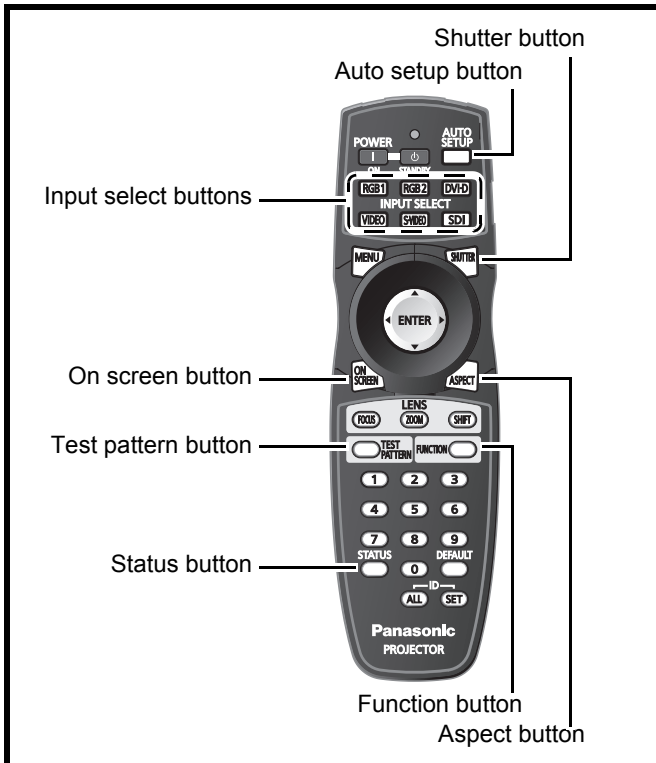

Operating range

You can operate the projector with the remote control within the remote range 30 m (98'5"), approximately $\pm 30^\circ$ horizontally and $\pm 15^\circ$ vertically.

● Facing to the projector

Ensure the remote control emitter is facing to the remote control signal receptor on front/back of the projector and press the required buttons to operate.

● Facing to the screen

Ensure the remote control emitter is facing to the screen and press the required buttons to operate the projector. The signal will be reflected off the screen. The operating range may differ due to the screen material. This function may not be effective with a translucent screen.

NOTE:

- Do not let strong light shine onto the signal receptor. The remote control may malfunction under strong light such as fluorescent.
- If there are any obstacles between the remote control and the remote control signal receptor, the remote control may not operate correctly.

Setting up the image position automatically



The automatic setup function can be used to automatically adjust the resolution, clock phase and picture position when analogue RGB signals consisting of bitmap images such as computer signals are being input, or to automatically adjust the picture position when DVI-D signals are being input.

1. Input an analogue RGB image signal.
2. Press the **AUTO SETUP** button.
3. Displays a message "**PROGRESS**".
4. Displays a message "**COMPLETE**" when ended.
 - When the performance is not completed and ended, displays "**INCOMPLETE**".

NOTE:

- The automatic setup function does not work with video format signals such as signals output from a DVD player.
- It is recommended to supply images with a bright white frame at the outermost periphery containing characters etc. that are clear in white and black contrast when the system is in automatic adjustment mode.
- Avoid supplying images that involve halftones or gradation such as photographs and computer graphics.
- The clock phase adjustment may have been shifted even when the adjustment ended normally. In this case, manually adjust **CLOCK PHASE** in **POSITION** menu.
- If an image with blurred edges or a dark image is input, "**INCOMPLETE**" may appear or adjustment may not be performed properly even if "**COMPLETE**" appears. In this case, manually adjust **INPUT RESOLUTION** in **ADVANCED MENU**, **CLOCK PHASE** and **SHIFT** in **POSITION** menu.
- For specific signals and landscape signals such as 16:9, see **AUTO SETUP** in **DISPLAY OPTION** menu of the functional instructions that is in the provided CD-ROM.
- Automatic adjustment may not be available depending on the machine type of the computer.
- Automatic adjustment may not be available for synchronisation signal of C-SYNC and G-SYNC.
- Image may be distorted for several seconds during automatic adjustment. This is not a malfunction.
- For every supplied signal, adjustment is required.
- Automatic adjustment can be cancelled by pressing the **MENU** button during the course of automatic adjustment.
- Even for an RGB signal for which automatic setup is possible, if automatic setup is performed while moving images are being input, "**INCOMPLETE**" may appear, or adjustment may not be performed properly even if "**COMPLETE**" appears.

Remote control operation

Switching the input signal



You can use the remote control to switch the signals that are being input and projected.

RGB1	Switches to RGB 1 IN.
RGB2	Switches to RGB 2 IN.
DVI-D	Switches to DVI-D IN.
VIDEO	Switches to VIDEO IN.
S-VIDEO	Switches to S-VIDEO IN.
SDI*1	Switches to SDI IN.

*1. **SDI** is only for PT-DZ6710E.

Stopping the projection



If the projector is not used for a certain period of time during the meeting intermission, for example, a shutter mode is available that allows the user to hide images temporarily.

- Press the **SHUTTER** button to block the projected light by the internal shutter, and press again to resume.

Clearing the screen



Press the **ON SCREEN** button to electronically mute the on-screen menus to avoid disrupting the program.

- Press the **ON SCREEN** button again to displays

Changing the picture aspect ratio



You can toggle through an appropriate set of aspect ratios for a given input signal. The setting will change each time the **ASPECT** button is pressed.

● Appearance sample

S-VIDEO signal

- **VID AUTO ▶ S1 AUTO ▶ VID AUTO(PRI.) ▶ THROUGH ▶ 16:9 ▶ 4:3 ▶ H-FIT ▶ V-FIT ▶ HV-FIT ▶ VID AUTO**

NOTE:

- The appearance of setting options vary according to input signals. See **ASPECT** in **POSITION** menu of the functional instructions that is in the provided CD-ROM.

Displaying the internal test pattern



The projector has 7 types of internal test patterns to check the condition of the set.

1. Display an input signal image.
2. Press the **TEST PATTERN** button.
3. Press **◀ ▶** to select the required test pattern.

NOTE:

- See **TEST PATTERN** menu of the functional instructions that is in the provided CD-ROM.

Using an assigned function



You can assign a selected function to the **FUNCTION** button. Following functions are assignable.

Options	Functions
DISABLE	Deactivate the FUNCTION button.
SUB MEMORY LIST	Display the assigned SUB MEMORY LIST .
SYSTEM SELECTOR	Switches the SYSTEM SELECTOR options.
SYSTEM DAYLIGHT VIEW	Switches the SYSTEM DAYLIGHT VIEW setting.
FREEZE	Freezes the image.
SIDE BY SIDE	Start the SIDE BY SIDE mode.

NOTE:

- See **FUNCTION** in **PROJECTOR SETUP** menu and each corresponding menu items of the functional instructions that is in the provided CD-ROM.

Displaying the status of the projector



Pressing this button displays several pages of projector status information.

NOTE:

- See **STATUS** in **PROJECTOR SETUP** menu and “Accessing with the web browser” in Technical Information of the functional instructions that is in the provided CD-ROM.

Resetting to the factory default



If an adjustment item is selected and press the **DEFAULT** button, the adjustment value will return to the factory default setting.

Menu Navigation

Main menu and Sub-menu

The menu options are structured and categorised. You can navigate through the menu with ▲ ▼ ◀ ▶ buttons. See "Navigating through the menu" on page 27.

- Some default settings vary by the selected input signal.
- Sub-menu items vary according to the selected input signal.
- Some settings are adjustable without any signals.
- See the functional indications in the CD-ROM that is provided with the projector.



PICTURE

PICTURE MODE

STANDARD	CINEMA
NATURAL	DYNAMIC
GRAPHIC	

CONTRAST

(Default: 0)

BRIGHTNESS

(Default: 0)

COLOR

(Default: 0)

TINT

(Default: 0)

COLOR TEMPERATURE

DEFAULT	USER
MIDDLE	HIGH

WHITE GAIN

(Default: 10)

SYSTEM DAYLIGHT VIEW

OFF	1
2	3

SHARPNESS

(Default: 6)

NOISE REDUCTION

1	2
3	OFF

AI

ON	OFF
----	-----

SYSTEM SELECTOR

AUTO	NTSC	NTSC 4.43	PAL
PAL-M	PAL-N	SECAM	PAL60
RGB	YCBCR	VGA60	480p
480pRGB	YPBPR	1080/60i	1035/60i
720/60p	1080/24p	1080/50i	1080/30p
1080/25p	1080/24sF	720/50p	480i
576i			



POSITION

SHIFT

ASPECT

DEFAULT	VID AUTO	S1 AUTO
VID AUTO(PRI.)		THROUGH
16:9	4:3	H-FIT
V-FIT	HV-FIT	

ZOOM

INTERNAL	FULL
----------	------

CLOCK PHASE

(Default: 16)

GEOMETRY

(PT-DZ6710E only)

OFF	KEystone
CURVED	PC

GEOMETRY:KEystone

VERTICAL KEystone
VERTICAL SUB KEystone
HORIZONTAL KEystone
HORIZONTAL SUB KEystone
LINEARITY

GEOMETRY:CURVED

LENS THROW RATIO
VERTICAL KEystone
HORIZONTAL KEystone
VERTICAL ARC
HORIZONTAL ARC
VERTICAL BALANCE
HORIZONTAL BALANCE

KEystone

(PT-DZ6700E/PT-DW6300E/PT-D6000E only)

VERTICAL KEystone
VERTICAL SUB KEystone
LINEARITY



ADVANCED MENU

DIGITAL CINEMA REALITY

AUTO	OFF
25p FIXED	30p FIXED

BLANKING

UPPER	LOWER
LEFT	RIGHT

INPUT RESOLUTION

TOTAL DOTS	DISPLAY DOTS
TOTAL LINES	DISPLAY LINES

CLAMP POSITION

EDGE BLENDING

OFF ON

GAMMA

2.2 1.8 2

BRIGHT ADJUST

BRIGHT INSIDE BRIGHT OUTSIDE
OUTSIDE AREA

RASTER POSITION

VERTICAL HORIZON



DISPLAY LANGUAGE

ENGLISH	РУССКИЙ
DEUTSCH	한국어
FRANÇAIS	中文
ESPAÑOL	日本語
ITALIANO	



DISPLAY OPTION

COLOR MATCHING

OFF 3 COLORS
7 COLORS MEASURED

COLOR CORRECTION

OFF USER

CONTRAST MODE

NORMAL HIGH

SCREEN SETTING

SCREEN FORMAT

16:10 16:9 4:3

SCREEN POSITION

AUTO SIGNAL

ON OFF

AUTO SETUP

DEFAULT WIDE
USER

DVI-D IN

DVI EDID

EDID3 EDID1 EDID2(PC)

DVI SIGNAL LEVEL

0-255:PC 16-235

SDI IN

64-940 4-1019

ON-SCREEN DISPLAY

OSD POSITION

1 2 3
4 5 6
7 8 9

OSD DESIGN

1 2 3
4 5 6

OSD MEMORY

ON OFF

INPUT GUIDE

ON OFF

WARNING MESSAGE

ON OFF

BACK COLOR

BLACK BLUE
LOGO1 LOGO2

STARTUP LOGO

LOGO2 NONE
LOGO1

FREEZE

SIDE BY SIDE

VIDEO S-VIDEO
RGB1 RGB2
DVI-D SDI
OFF



PROJECTOR SETUP

PROJECTOR ID

ALL 1 - 64

INSTALLATION

FRONT/FLOOR FRONT/CEILING
REAR/FLOOR REAR/CEILING

HIGH ALTITUDE MODE

OFF ON

COOLING CONDITION

FLOOR SETTING
VERTICAL DOWN SETTING
CEILING SETTING
VERTICAL UP SETTING

LAMP SELECT

DUAL SINGLE
LAMP1 LAMP2

LAMP RELAY

OFF 00:00 - 23:00

LAMP POWER

HIGH LOW

STANDBY MODE

NORMAL ECO

RS-232C

(IN) BAUDRATE
(IN) PARITY
(OUT) BAUDRATE
(OUT) PARITY
RESPONSE(ID ALL)
GROUP
RESPONSE(ID GROUP)

REMOTE2 MODE

DEFAULT USER

STATUS

FILTER COUNTER RESET

NO SIGNAL SHUT-OFF

DISABLE
15 MIN. 20 MIN. 25 MIN. 30 MIN.
35 MIN. 40 MIN. 45 MIN. 50 MIN.
55 MIN. 60 MIN.

FUNCTION BUTTON

DISABLE
SUB MEMORY LIST
SYSTEM SELECTOR
SYSTEM DAYLIGHT VIEW
FREEZE
SIDE BY SIDE

DAY AND TIME

TIME ZONE ADJUST CLOCK

SAVE ALL USER DATA

LOAD ALL USER DATA

INITIALIZE

SERVICE PASSWORD



TEST PATTERN

TEST PATTERN



SIGNAL LIST

REGISTERED SIGNAL STATUS
SUB MEMORY LIST

Menu Navigation



SECURITY

SECURITY PASSWORD

OFF ON

SECURITY PASSWORD CHANGE

DISPLAY SETTING

OFF TEXT
LOGO1 LOGO2

TEXT CHANGE

MENU LOCK

OFF ON

MENU LOCK PASSWORD

CONTROL DEVICE SETUP

CONTROL PANEL
ENABLE DISABLE

REMOTE CONTROLLER
ENABLE DISABLE



NETWORK

NETWORK SETUP

HOST NAME DHCP
IP ADDRESS SUBNET MASK
DEFAULT GATEWAY STORE

NETWORK CONTROL

WEB CONTROL
PJLink CONTROL
COMMAND CONTROL
COMMAND PORT
STORE

NETWORK STATUS

DHCP IP ADDRESS
SUBNET MASK DEFAULT GATEWAY
DNS1 DNS2
MAC ADDRESS

Navigating through the menu

■ Displaying the Main menu

Press the **MENU** button to display the main menu.

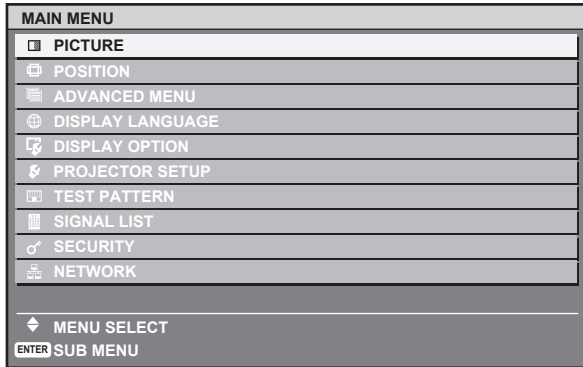

■ Adjusting with the bar scale items

The triangle mark under the bar indicates factory default setting and the square indicates the current setting.



■ Returning to the previous menu

Press the **MENU** button to return to the previous menu. Press repeatedly to escape from the menu mode and return to the projection.

■ Operating procedure

1. Press **▲ ▼** to scroll to the required main menu item and press the **ENTER** button to select.
 - The selected item is highlighted in orange and the sub-menu is displayed.
 - See "Main menu and Sub-menu" on page 24.

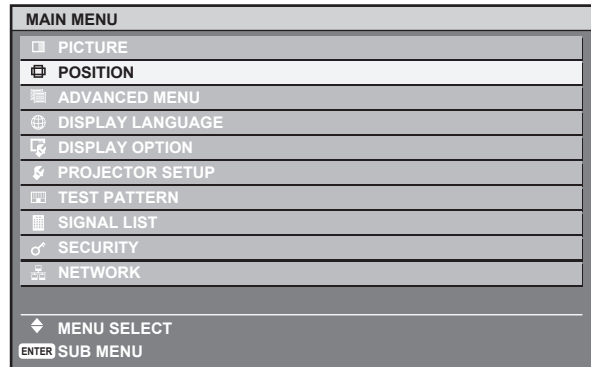

2. Press **▲ ▼** to scroll to the required sub-menu item and press **◀ ▶** or the **ENTER** button to adjust.
 - The selected item is called up and the other menu items disappear from the screen. Called up item will disappear after 5 seconds and return to the menu mode.
 - If there is a lower level, the next level will be displayed.

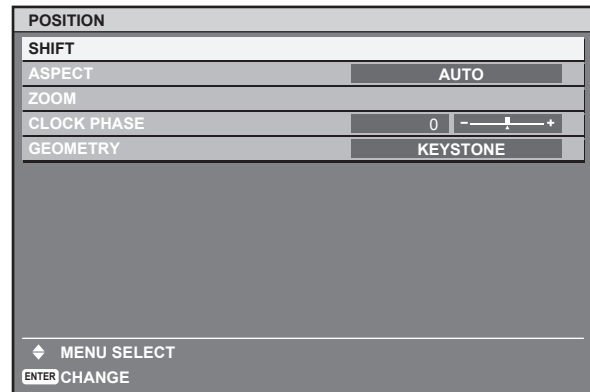

3. Press **◀ ▶** to adjust or set the selected item.
 - For items using a bar scale, the current settings are displayed on the left of the bar scale.
 - You can cycle through the options of an item by pressing **◀ ▶**.



4. Press the **MENU** button to return to the previous menu.

Monitor Lamp indicators

Managing the indicated problems

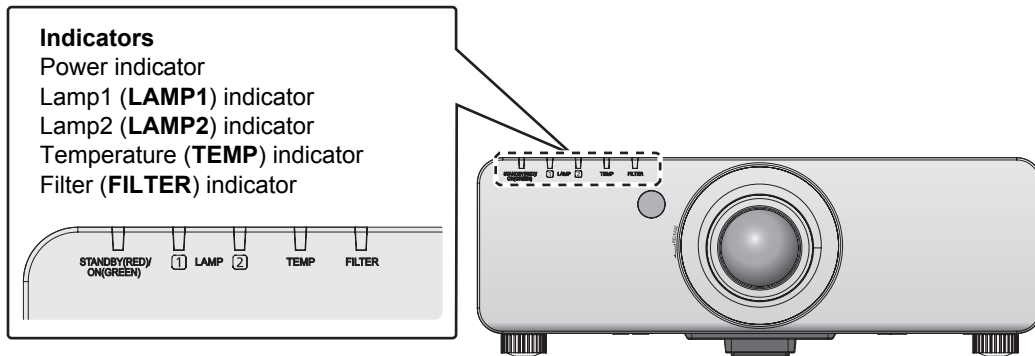

If a problem should occur with the projector, the indicators will inform you. Manage the indicated problems as follow.

1. Confirm the status of all indicators and projector, and switch off the projector in proper way.
2. Find out the cause of the problem by status of each indicator.
3. Follow the instruction for each indication below and solve the problem.
4. Turn on the projector in the correct way and confirm the indicator is not indicating a problem any longer.

NOTE:

- If no problem is found or the problem remains, do not turn on the projector. Instead contact an Authorised Service Centre.

LAMP1/LAMP2 indicator

Lamp indication	Information	Check point	Remedial measure
Lighting in red	Indicates the time for replacing the lamp unit	<ul style="list-style-type: none"> • Did you notice a “REPLACE LAMP” message on the screen when turning on the projector power supply? 	<ul style="list-style-type: none"> • This lamp monitor lights up when the lamp unit used hours have reached 1 800 hours. Request the dealer to replace the lamp unit.
Blinking in red once	Lamp unit is not installed.	<ul style="list-style-type: none"> • Check the lamp unit compartment. 	<ul style="list-style-type: none"> • Install the lamp unit. • When lamp unit is installed and still having the indicator lights, contact to the dealer.
Blinking in red 3 times	Error is detected in the lamp circuit.	<ul style="list-style-type: none"> • Did you turn the power back on immediately after turning it off? • Some error has arisen in the lamp circuit. • Check for fluctuation (or drop) in the source voltage. 	<ul style="list-style-type: none"> • Wait until the lamp has cooled off, and then turn on the power. • Turn off the POWER switch of the projector in proper way and contact the dealer.

TEMP indicator

Lamp indication	Information	Check point	Remedial measure
Lighting in red	Warm-up status	<ul style="list-style-type: none"> • Did you turn on the power when the ambient temperature was lower than approx. 0 °C (32 °F)? 	<ul style="list-style-type: none"> • Wait about 5 minutes in the current status. • Install the unit in a location having an ambient temperature from 0 °C (32 °F) - 45 °C (113 °F).
	High temperature inside. (WARNING)	<ul style="list-style-type: none"> • Check the ventilation port is blocked. • Is the room air temperature too high? • Was the temperature warning indication displayed? 	<ul style="list-style-type: none"> • Remove the object that is blocking the ventilation port. • Move the projector to a temperature of 0 °C (32 °F) - 45 °C (113 °F) and the humidity of 20 % to 80 % (no condensation).
Blinking in red twice	High temperature inside. (Standby condition)	<ul style="list-style-type: none"> • Was the temperature warning indication displayed? 	<ul style="list-style-type: none"> • Turn off the POWER switch of the projector in proper way and contact the dealer.
Blinking in red 3 times	Cooling fan has been stopped.		<ul style="list-style-type: none"> • Turn off the POWER switch of the projector in proper way and contact the dealer.

FILTER indicator

The **FILTER** indicates the Auto Cleaning Filter (ACF) unit status.

Lamp indication	Information	Check point	Remedial measure
Lighting in red	The ACF unit has run out.	• Check the REMAINING FILTER of STATUS in PROJECTOR SETUP menu.	• Replace the ACF unit.
Blinking in red	The ACF unit is not installed.*1	• Check the ACF unit compartment.	• Replace the ACF unit.
Lighting in orange	The ACF unit remains few. The remaining use time of the ACF unit is approximately 200 hours.*2	• Check the REMAINING FILTER of STATUS in PROJECTOR SETUP menu.	• Request the dealer to purchase the new ACF unit.
Blinking in orange	The ACF unit cannot operate properly.	• Is foreign object blocking the ACF unit operation?	• Remove the foreign object from the ACF unit. • When the foreign object still remained, contact the dealer.

*1. When the ACF unit is not installed, displays "**THE AIR FILTER HAS NOT BEEN INSTALLED PROPERLY.**" message and power off with the indicator blinking in red.

*2. 200 hours is the roughly guided time.

NOTE:

- When the **FILTER** indicator is flashing green, the Auto Cleaning Filter (ACF) is normally rolling up.
- When the ACF unit is operating, operational sound may be heard.
- In a dusty environment, the guided remaining use time will be shorter. Contact the dealer to purchase the new ACF unit earlier.
- If using the projector at high elevations 1 400 - 2 700 m (4 593 - 8 858 ft) sea level and **HIGH ALTITUDE MODE** in **PROJECTOR SETUP** menu is **OFF**, it may cause malfunction of the ACF unit.

Replacement

Replacing the Lamp unit

Before replacing the Lamp unit

- Turn off the **POWER** switch of the projector in proper way and disconnect the mains plug from the mains socket.
- Wait for more than 1 hour and make sure the lamp unit and the surroundings are cooled enough.
- Prepare a Phillips-head screwdriver.
- Contact the dealer to purchase a replacement lamp unit (ET-LAD60:1 bulb unit, ET-LAD60W: 2 bulb units).
- When the projector is mounted on the ceiling, do not work directly under the projector or put your face closer to the projector.

CAUTION:

- The lamp may explode or shorten the lamp life by shocks or chipping damage.

NOTE:

- Prior to replacing the lamp unit, allow it to cool down to prevent the risk of burns, damage and other hazards.
- Do not attempt replacement with an unauthorised lamp unit.

When to replace the lamp unit

The lamp unit is consumable and the brightness decreases by duration of usage. The **LAMP1/LAMP2** indicators will inform you of the replacement timing at 1 800 hours, and at 2 000 hours, the projector will be turned off. Those figures are rough guidance and might be shortened by the usage conditions, characteristics of the lamp unit, environmental conditions, and so on. You can check the duration of usage time using **LAMP1/LAMP2** of **STATUS** in the **PROJECTOR SETUP** menu.

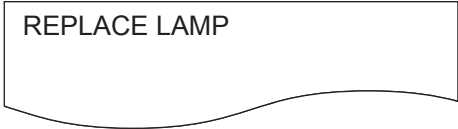
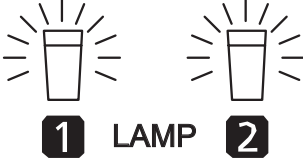
Indication	On screen	LAMP indicator
Over 1 800 hours		
Over 2 000 hours	<p>“REPLACE LAMP” is displayed on the upper left of the screen for 10 minutes. Press any button to clear the screen, or disappears after 10 minutes.</p> <p>“REPLACE LAMP” is displayed on the upper left of the screen, and it will stay until you respond. To clear the screen, press any button.</p>	Lights in red

CAUTION:

- If you keep using the lamp unit after 2 000 hours, it cause the damage of the projector. Automatically the projector will be powered off after 10 minutes.

NOTE:

- The guide times, 1 800 and 2 000 hours, are rough estimates based on certain conditions and are not a guaranteed time.
- For more information about the lamp unit, such as guaranteed time, see the instructions which is provided with the lamp unit.

Replacement procedure

Removing and replacing the lamp unit

1. Use a Phillips-head screwdriver to loosen the 1 lamp unit cover fixing screw on the back of the projector until the screws turn freely, and remove the lamp unit cover.
 - Slide the lamp unit cover to the buttons and pull to remove.

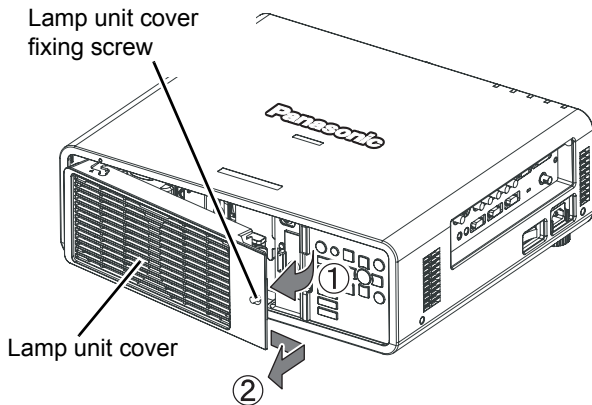

2. Use a Phillips-head screwdriver to remove the 3 lamp unit fixing screws.
3. Hold the handles of the lamp unit and pull the used lamp unit gently from the projector.

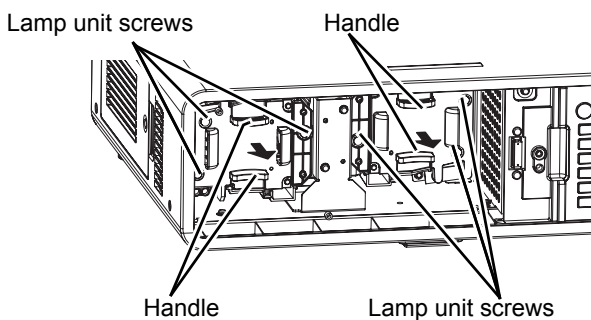

4. Hold the handle of the new lamp unit and replace it in correct direction.
5. Press in the lamp unit until it clicks and make sure the unit is installed securely.
6. Tighten the 3 lamp unit fixing screws securely with a Phillips-head screwdriver.

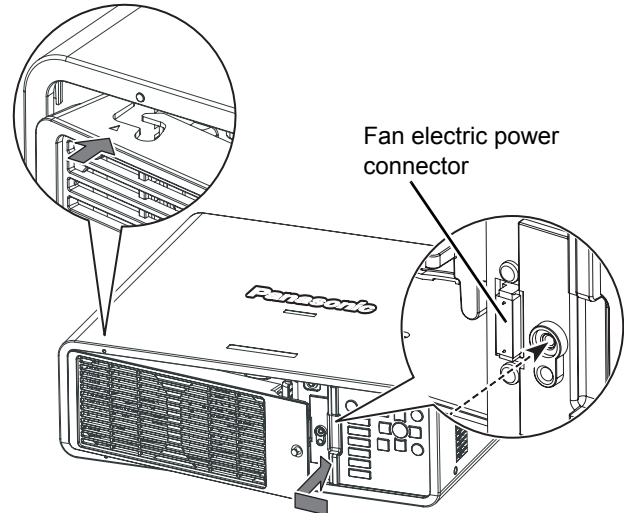

7. Attach the lamp unit cover and tighten the 1 lamp unit cover fixing screw securely with a Phillips-head screwdriver.
 - Slide the lamp unit cover to the hinge side and push in to attach securely.
 - Make sure the fan electric power connector of the lamp unit cover is inserted securely to the projector's connector.

Replacing the Auto Cleaning Filter (ACF)

Before replacing the ACF

- Wait until the cooling fan stops and turn off the **POWER** switch of the projector in proper way.
- Disconnect the mains lead from the mains socket.
- Contact an Authorised Service Centre to purchase a replacement ACF (ET-ACF100).

When to replace the ACF

The ACF unit is consumable product and effects on ventilation. The **FILTER** indicator will inform you of the replacement timing. You can check the remaining amount of the ACF unit in **REMAINING FILTER** of **STATUS** in **PROJECTOR SETUP** menu.

Replacement

Replacement procedure

1. Loosen 1 ACF cover fixing screw until the screws turn freely and remove the ACF cover.

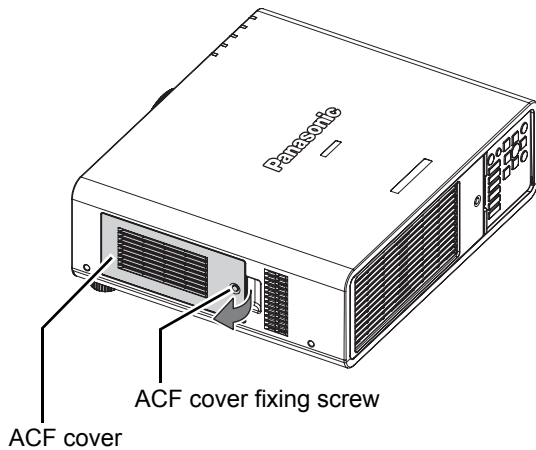

2. Slide out the ACF unit from the projector slowly.
 - When you replace the ACF unit, clean the compartment and/or the air exhaust port if you need to.
3. Insert the new ACF unit into the compartment in correct direction and slightly push until it clicks.

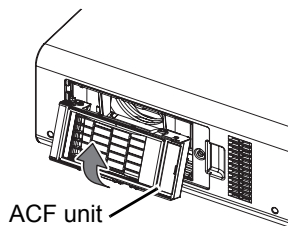

4. Attach the ACF cover and tighten 1 ACF cover fixing screw securely.

NOTE:

- If the ACF and/or ACF cover are attached incorrectly, the projector may not be turned on.
- Do not switch the power on while the ACF cover removed.
- The replacement timing of the ACF is 36 000 hours of use at maximum and it depends on environment of usage.

Resetting the REMAINING FILTER

1. Turn on the projector and display the **FILTER COUNTER RESET** in **PROJECTOR SETUP** menu.
2. Press the **ENTER** button.
 - The confirmation screen will be displayed.
3. Select **OK** by pressing **◀**, then press the **ENTER** button.
4. Display the **STATUS** in **PROJECTOR SETUP** menu and confirm the **REMAINING FILTER**.

NOTE:

- See **FILTER COUNTER RESET** and **STATUS** in **PROJECTOR SETUP** menu of the functional instructions that is in the provided CD-ROM.

Troubleshooting

Should any problem persist, contact your dealer.

Problem	Cause	Reference page *1
Power does not turn on.	<ul style="list-style-type: none"> ● The mains lead may not be connected. ● The POWER switch is turned off. ● No electric supply is at the mains socket. ● TEMP indicator is lit or flashes. ● LAMP1/LAMP2 indicator is lit or flashes. ● The lamp unit cover has not been securely installed. ● The circuit breakers have tripped. 	18 19 19 28 28 31 -
No picture appears.	<ul style="list-style-type: none"> ● The video signal input source may not be connected to a terminal properly. ● The input selection setting may not be correct. ● The BRIGHTNESS adjustment setting may be at the minimum setting. ● The input source which is connected to the projector may have a problem. ● The shutter function may be in use. 	CD-ROM 22 CD-ROM 22
The picture is fuzzy.	<ul style="list-style-type: none"> ● The lens focus may not have been set correctly. ● The projector may not be at the correct distance from the screen. ● The lens may be dirty. ● The projector may be tilted too much. 	19 CD-ROM - CD-ROM
The colour is pale or greyish.	<ul style="list-style-type: none"> ● COLOR or TINT adjustment may be incorrect. ● The input source which is connected to the projector may not be adjusted correctly. ● RGB cable is damaged. 	CD-ROM - -
The control buttons of the projector do not operate.	<ul style="list-style-type: none"> ● CONTROL PANEL of CONTROL DEVICE SETUP in SECURITY menu is disabled. If you have a loss of the remote control while the CONTROL PANEL is disabled, press and hold the MENU button for 2 seconds with pressing the ENTER button. 	CD-ROM
The remote control does not operate.	<ul style="list-style-type: none"> ● REMOTE CONTROLLER of CONTROL DEVICE SETUP in SECURITY menu is disabled. ● The batteries may be weak. ● The batteries may not have been inserted correctly. ● The remote control signal receptor on the projector may be obstructed. ● The remote control unit may be out of the operation range. ● Strong light such as fluorescent shine onto the signal receptor. ● The remote control ID setting is incorrect. 	CD-ROM - 14 21 21 - CD-ROM
The picture does not display correctly.	<ul style="list-style-type: none"> ● The colour format may not have been set correctly. ● There may be a problem with the VCR or other signal source. ● A signal which is not compatible with the projector is being input. 	CD-ROM - 34
Picture from a computer does not appear.	<ul style="list-style-type: none"> ● The cable may be longer than the optional cable. ● The external video output from a laptop computer may not be correct. (You may be able to change the external output settings by pressing the [Fn] + [F3] or [Fn] + [F10] keys simultaneously. The actual method varies depending on the type of computer; refer to the documentation provided with your computer for further details.) 	- -
Picture from a computer DVI-D graphic board does not appear.	<ul style="list-style-type: none"> ● The graphic board driver of the computer needs to be updated to the latest version. ● DVI-D IN setting in DISPLAY OPTION menu may be incorrect setting. ● The computer may need to be restarted after switching DVI-D IN setting in DISPLAY OPTION menu of the projector correctly. 	- CD-ROM -

*1. CD-ROM: See the functional instructions in the provided CD-ROM.

Technical Information

List of compatible signals

Mode	Display resolution (dots) ^{*1}	Scanning frequency		Dot clock frequency	Picture quality ^{*2}	PnP ^{*3}			Format ^{*4}
		H (kHz)	V (Hz)	(MHz)		RGB2	DVI-D EID11	DVI-D EID12	
NTSC/NTSC 4.43/ PAL-M/PAL60	720 x 480i	15.7	59.9	-	A				V/S
PAL/PAL-N/SECAM	720 x 576i	15.6	50.0	-	A				R/Y
525i (480i)	720 x 480i	15.7	59.9	13.5	A				
625i (576i)	720 x 576i	15.6	50.0	13.5	A				D/R/Y
525p (480p)	720 x 483	31.5	59.9	27.0	A		●		
625p (576p)	720 x 576	31.3	50.0	27.0	A		●		
1 125 (1 080)/60i	1 920 x 1 080i	33.8	60.0	74.3	AA ^{*5}		●		
1 125 (1 080)/50i		28.1	50.0	74.3	AA ^{*5}		●		
1 125 (1 080)/24p	1 920 x 1 080	27.0	24.0	74.3	AA ^{*5}		●		
1 125 (1 080)/24sF	1 920 x 1 080i	27.0	24.0	74.3	AA ^{*5}				
1 125 (1 080)/25p	1 920 x 1 080	28.1	25.0	74.3	AA ^{*5}		●		
1 125 (1 080)/30p		33.8	30.0	74.3	AA ^{*5}				
1 125 (1 080)/60p	1 920 x 1 080p	67.5	60.0	148.5	AA ^{*5}		●		
1 125 (1 080)/50p		56.3	50.0	148.5	AA ^{*5}		●		
750 (720)/60p	1 280 x 720	45.0	60.0	74.3	AA ^{*6}		●		
750 (720)/50p		37.5	50.0	74.3	AA ^{*6}		●		
VGA400	640 x 400	31.5	70.1	25.2	A				D/R
		37.9	85.1	31.5	A				
VGA480	640 x 480	31.5	59.9	25.2	A	●	●	●	
		35.0	66.7	30.2	A				
		37.9	72.8	31.5	A	●		●	
		37.5	75.0	31.5	A	●		●	
SVGA	800 x 600	43.3	85.0	36.0	A				
		35.2	56.3	36.0	A	●		●	
		37.9	60.3	40.0	A	●		●	
		48.1	72.2	50.0	A	●		●	
		46.9	75.0	56.3	A	●		●	
MAC16	832 x 624	49.7	74.6	57.3	A	●		●	
XGA	1 024 x 768	39.6	50.0	51.9	AA ^{*7}				
		48.4	60.0	65.0	AA ^{*7}	●		●	
		56.5	70.1	75.0	AA ^{*7}	●		●	
		60.0	75.0	78.8	AA ^{*7}	●		●	
		65.5	81.6	86.0	AA ^{*7}				
		68.7	85.0	94.5	AA ^{*7}				
		80.0	100.0	105.0	AA ^{*7}				
MXGA	1 152 x 864	96.7	120.0	130.0	AA ^{*7}				
		64.0	71.2	94.2	A				
		67.5	74.9	108.0	A				
MAC21	1 152 x 870	76.7	85.0	121.5	A				
1 280 x 768	1 280 x 960	68.7	75.1	100.0	A	●		●	
		39.6	49.9	65.3	AA ^{*6}				
1 280 x 800	1 280 x 800	47.8	59.9	79.5	AA ^{*6}				
		41.3	50.0	68.0	AA ^{*6}				
MSXGA	1 280 x 960	49.7	59.8	83.5	AA ^{*6}				
		60.0	60.0	108.0	A				
SXGA	1 280 x 1 024	64.0	60.0	108.0	A	●		●	
		80.0	75.0	135.0	A	●		●	
		91.1	85.0	157.5	A ^{*8}				
SXGA+	1 400 x 1 050	65.2	60.0	122.6	A	●		●	
		82.2	75.0	155.9	A ^{*8}				
WXGA+	1 440 x 900	55.9	59.9	106.5	A				
UXGA	1 600 x 1 200	75.0	60.0	162.0	A ^{*8}	●		●	

Mode	Display resolution (dots) ^{*1}	Scanning frequency		Dot clock frequency	Picture quality ^{*2}	PnP ^{*3}			Format ^{*4}
		H (kHz)	V (Hz)	(MHz)		RGB2	DVI-D EIDI1	DVI-D EIDI2	
WSXGA+	1 680 x 1 050	65.3	60.0	146.3	A				D/R
1 920 x 1 080 ^{*10}	1 920 x 1 080	66.6	59.9	138.5	AA ^{*5}				
WUXGA	1 920 x 1 200	74.0	60.0	154.0	AA ^{*5}	●		●	

*1. The "i" appearing after the resolution indicates an interlaced signal.

*2. The following symbols are used to indicate picture quality.

AA Maximum picture quality can be obtained.

A Signals are converted by the image processing circuit before picture is projected.

B Some loss of data occurs to make projection easier.

*3. Marked signals are indicated in

*4. The following symbols are used to indicate the format.

V = VIDEO, S = S-VIDEO, D = DVI, R = RGB, Y = YPBPR

*5. PT-DW6300E/PT-D6000E: A

*6. PT-DZ6710E/PT-DZ6700E/PT-D6000E: A

*7. PT-DZ6710E/PT-DZ6700E/PT-DW6300E: A

*8. PT-DW6300E/PT-D6000E: B

*9. RGB signals only and DVI-D is not compatible.

*10. VESA CVT-RB (Reduced Blanking) compatible.

NOTE:

- Projecting an interlaced signal may cause flicker in screen.

Display dots of each model

PT-DZ6710E	1 920 x 1 200
PT-DZ6700E	1 920 x 1 200
PT-DW6300E	1 280 x 800
PT-D6000E	1 024 x 768

Technical Information

Specifications

Power supply		AC 220 - 240 V 50 Hz/60 Hz																																
Power consumption		<ul style="list-style-type: none"> PT-DZ6710E/PT-DZ6700E: 800 W PT-DW6300E/PT-D6000E: 750 W 																																
		During standby (when fan is stopped): Approx. 9 W ^{*1}																																
Amps		<ul style="list-style-type: none"> PT-DZ6710E/PT-DZ6700E: 4.3 A PT-DW6300E/PT-D6000E: 3.8 A 																																
DLP™ chip	Panel size (diagonal)	<ul style="list-style-type: none"> PT-DZ6710E/PT-DZ6700E: 0.67 type 	<ul style="list-style-type: none"> PT-DW6300E: 0.65 type PT-D6000E: 0.7 type 																															
	Aspect ratio	<ul style="list-style-type: none"> PT-DZ6710E/PT-DZ6700E/PT-DW6300E: 16 : 10 PT-D6000E: 4:3 																																
	Display method	1 unit DLP™ chip, DLP™ type																																
	Pixels	<ul style="list-style-type: none"> PT-DZ6710E/PT-DZ6700E: 2 304 000 (1 920 x 1200) PT-DW6300E: 1 024 000 (1 280 x 800) PT-D6000E: 786 432 (1 024 x 768) 																																
Lens	Motorised zoom	1.8 - 2.4:1	<ul style="list-style-type: none"> Lens is optional for the projectors that "L" follows in model number. 																															
	Motorised focus	<ul style="list-style-type: none"> F 1.7 - 2.0, f 25.6 mm - 33.8 mm PT-DZ6710E/PT-DZ6700E: f = 26.8 - 35.7 PT-DW6300E/PT-D6000E: f = 25.6 - 33.8 																																
Lamp		UHM lamp (300 W) x 2																																
Luminosity^{*2}		<ul style="list-style-type: none"> PT-DZ6710E/PT-DZ6700E/PT-DW6300E: 6 000 lm (ANSI) PT-D6000E: 6 500 lm (ANSI) <p>Average value of the lens that is provided with the projector.</p>	<ul style="list-style-type: none"> Lens is optional for the projectors that "L" follows in model number. 																															
Operating environment		<p>Temperature: 0 °C - 45 °C (32 °F - 113 °F)</p> <p>Humidity: 20% - 80% (no condensation)</p>																																
Scanning frequency^{*3}	VIDEO/S-VIDEO	H: 15.75 kHz/15.63 kHz, V: 50 Hz/60 Hz																																
	RGB	<p>H: 15 - 91 kHz, V: 50 - 85 Hz Panasonic Intelligent Auto Scanning (PIAS)</p> <p>Dot clock frequency</p> <ul style="list-style-type: none"> PT-DZ6710E/PT-DZ6700E: 162 MHz or less PT-DW6300E/PT-D6000E: 150 MHz or less 																																
	DVI-D	<p>480p, 576p, 720/60p, 720/59.94p, 720/50p, 1 080/60p, 1 080/59.94p, 1 080/50p, 1 080/60i, 1 080/59.94i, 1 080/50i, 1 080/24sF, 1 080/23.98sF, 1 080/30p, 1 080/29.97p, 1 080/25p, 1 080/24p, 1 080/23.98p</p> <p>Displayable resolution: VGA - WUXGA (non interlace)</p> <p>Dot clock frequency: 25 - 162 MHz</p> <p>WUXGA signal is applicable with VESA CVT-RB (Reduced Blanking).</p>																																
	YPBPR	<table border="0"> <tr> <td>• 480i</td> <td>H: 15.73 kHz, V: 59.94 Hz</td> <td>• 576i</td> <td>H: 15.63 kHz, V: 50 Hz</td> </tr> <tr> <td>• 480p</td> <td>H: 31.5 kHz, V: 59.94 Hz</td> <td>• 576p</td> <td>H: 31.25 kHz, V: 50 Hz</td> </tr> <tr> <td>• 720/50p</td> <td>H: 37.5 kHz, V: 50 Hz</td> <td>• 720/60p</td> <td>H: 45 kHz, V: 60 Hz</td> </tr> <tr> <td>• 1 035/60i</td> <td>H: 33.75 kHz, V: 60 Hz</td> <td>• 1 080/50i</td> <td>H: 28.13 kHz, V: 50 Hz</td> </tr> <tr> <td>• 1 080/60i</td> <td>H: 33.75 kHz, V: 60 Hz</td> <td>• 1 080/24p</td> <td>H: 27 kHz, V: 24 Hz</td> </tr> <tr> <td>• 1 080/25p</td> <td>H: 28.13 kHz, V: 25 Hz</td> <td>• 1 080/30p</td> <td>H: 33.75 kHz, V: 30 Hz</td> </tr> <tr> <td>• 1 080/24sF</td> <td>H: 27 kHz, V: 48 Hz</td> <td>• 1 080/50p</td> <td>H: 56.25 kHz, V: 50 Hz</td> </tr> <tr> <td>• 1 080/60p</td> <td>H: 67.5 kHz, V: 60 Hz</td> <td></td> <td></td> </tr> </table> <p>HD/SYNC, VD terminals are not compliant with 3 value composite SYNC.</p>		• 480i	H: 15.73 kHz, V: 59.94 Hz	• 576i	H: 15.63 kHz, V: 50 Hz	• 480p	H: 31.5 kHz, V: 59.94 Hz	• 576p	H: 31.25 kHz, V: 50 Hz	• 720/50p	H: 37.5 kHz, V: 50 Hz	• 720/60p	H: 45 kHz, V: 60 Hz	• 1 035/60i	H: 33.75 kHz, V: 60 Hz	• 1 080/50i	H: 28.13 kHz, V: 50 Hz	• 1 080/60i	H: 33.75 kHz, V: 60 Hz	• 1 080/24p	H: 27 kHz, V: 24 Hz	• 1 080/25p	H: 28.13 kHz, V: 25 Hz	• 1 080/30p	H: 33.75 kHz, V: 30 Hz	• 1 080/24sF	H: 27 kHz, V: 48 Hz	• 1 080/50p	H: 56.25 kHz, V: 50 Hz	• 1 080/60p	H: 67.5 kHz, V: 60 Hz	
• 480i	H: 15.73 kHz, V: 59.94 Hz	• 576i	H: 15.63 kHz, V: 50 Hz																															
• 480p	H: 31.5 kHz, V: 59.94 Hz	• 576p	H: 31.25 kHz, V: 50 Hz																															
• 720/50p	H: 37.5 kHz, V: 50 Hz	• 720/60p	H: 45 kHz, V: 60 Hz																															
• 1 035/60i	H: 33.75 kHz, V: 60 Hz	• 1 080/50i	H: 28.13 kHz, V: 50 Hz																															
• 1 080/60i	H: 33.75 kHz, V: 60 Hz	• 1 080/24p	H: 27 kHz, V: 24 Hz																															
• 1 080/25p	H: 28.13 kHz, V: 25 Hz	• 1 080/30p	H: 33.75 kHz, V: 30 Hz																															
• 1 080/24sF	H: 27 kHz, V: 48 Hz	• 1 080/50p	H: 56.25 kHz, V: 50 Hz																															
• 1 080/60p	H: 67.5 kHz, V: 60 Hz																																	
Colour system		7 (NTSC/NTSC 4.43/PAL/PAL-M/PAL-N/PAL60/SECAM)																																
Projection size		50" - 600" (1 270 mm - 12 700 mm)																																
Screen aspect ratio		<ul style="list-style-type: none"> PT-DZ6710E/PT-DZ6700E/PT-DW6300E: 16 : 10 PT-D6000E: 4:3 																																
Installation		FRONT/FLOOR, FRONT/CEILING, REAR/FLOOR, REAR/CEILING (Menu selection method)																																
Contrast ratio		2 000 : 1 (When CONTRAST MODE in DISPLAY OPTION menu is set to HIGH)																																

Terminals	S-VIDEO IN	1 set, Mini DIN 4p Y: 1.0 V [p-p], C: 0.286 V [p-p], 75 Ω, compatible with S1 signal
	VIDEO IN	1 set, BNC pin jack 1.0 V [p-p], 75 Ω
	RGB 1 IN	1 set, BNC x 5 <ul style="list-style-type: none"> ● RGB signal 0.7 V [p-p], 75 Ω <ul style="list-style-type: none"> • G-SYNC: 1.0 V [p-p], 75 Ω • HD/SYNC: TTL high impedance, automatic positive/negative polarity compatible • VD: TTL high impedance, automatic positive/negative polarity compatible ● YPbPr signal <ul style="list-style-type: none"> • Y: 1.0 V [p-p] Synchronisation signal included • PbPr: 0.7 V [p-p], 75 Ω
	RGB 2 IN	1 set of high density, D-sub 15p (female) <ul style="list-style-type: none"> ● RGB signal 0.7 V [p-p], 75 Ω (G-SYNC: 1.0 V [p-p], 75 Ω) <ul style="list-style-type: none"> • HD/SYNC: TTL high impedance, automatic positive/negative polarity compatible • VD: TTL high impedance, automatic positive/negative polarity compatible ● YPbPr signal <ul style="list-style-type: none"> • Y: 1.0 V [p-p] Synchronisation signal included • PbPr: 0.7 V [p-p], 75 Ω
	DVI-D IN	1 set, DVI-D 24-pin (Single link), DVI 1.0 compatible, HDCP compatible
	SERIAL	1 set, D-sub 9-pin (female), RS-232C compatible, computer control use
	REMOTE1	1 set, M3 pin jack, wired remote control use, multiple connection use
	REMOTE2	1 set, D-sub 9-pin, external control use
	LAN	1 set, RJ-45, network connection use, PLink™ compatible, 10 Base-T/100Base-TX
	SDI	1 set, BNC pin jack <ul style="list-style-type: none"> • SD-SDI (Y, Cb, Cr, 4:2:2) • SMPTE259M: 480i, 576i • SMPTE292M: 720/50p, 720/60p, 1 035/60i, 1 080/50i, 1 080/60i, 1 080/25p, 1 080/24p, 1 080/24sF, 1 080/30p
Cabinet		Moulded plastic
Mains lead length		3.0 m (9'10")
Dimensions		Width 498 mm (19- 19/32") Height 175 mm (6 - 7/8") Length 448 mm (17 - 5/8")
Weight		Approx. 16 kg (35.3 lbs.)*4
Remote control	Power supply	3 V DC (AA battery x 2)
	Operating range	Approx. 30 m (98'5") (when operated directly in front of signal receptor)
	Weight	120 g (4.2 ozs.) (including batteries)
	Dimensions	Width 51 mm (2") Length 176 mm (6 - 29/32") Height 22.7 mm (-7/8") (not including surface projection parts)
Options	Ceiling bracket	ET-PKD56H (High ceiling), ET-PKD55S (Low ceiling)
	Projection lens	ET-DLE150, ET-DLE250, ET-DLE350, ET-DLE450, ET-DLE055
	Lamp unit	ET-LAD60 (1 bulb), ET-LAD60W (2 bulbs)
	ACF unit	ET-ACF100

*1. When STANDBY MODE in PROJECTOR SETUP menu is NORMAL: Approx. 9 W
When STANDBY MODE in PROJECTOR SETUP menu is ECO: Approx. 0.3 W

*2. Measurement, measuring conditions and method of notation all comply with ISO21118 international standards.

*3. See "List of compatible signals" on page 34 for available signals.

*4. Average value. Each product has an individual variable in weight.

Technical Information

Dimensions

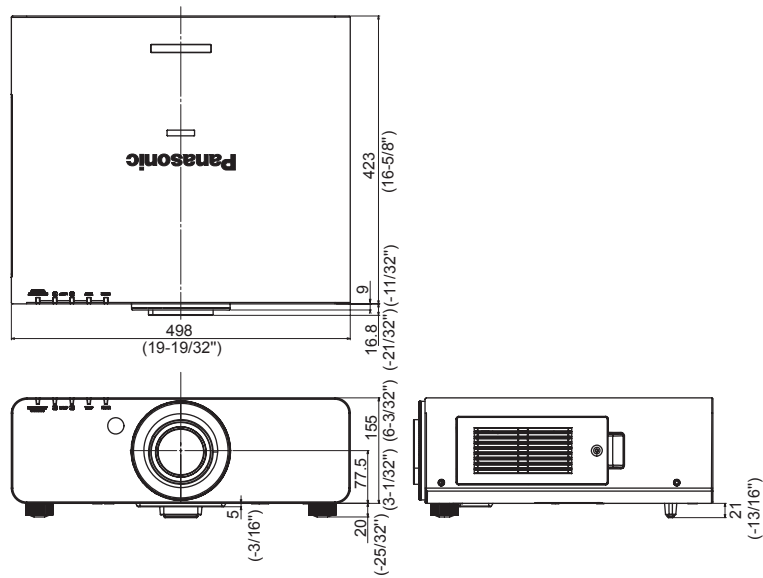

Unit: mm (inch)

Trademark acknowledgements

- VGA and XGA are trademarks of International Business Machines Corporation.
- S-VGA is a registered trademark of the Video Electronics Standards Association.
- The font used in the on-screen displays is a Ricoh bitmap font, which is manufactured and sold by Ricoh Company, Ltd.

All other trademarks are the property of the various trademark owners.

Index

A		
Accessories	11	
Air exhaust port	12	
Air intake port	13	
ASPECT		
Remote control button	14	
Remote control function	22	
Auto Cleaning Filter (ACF)	13	
AUTO SETUP		
Control panel button	12	
Remote control button	14	
Remote control function	21	
B		
Battery	11	
Compartment	14	
Burglar hook port	12	
C		
CD-ROM	11	
Accessories	11	
Menu	24	
D		
DEFAULT		
Remote control button	14	
Remote control function	23	
Dimensions	38	
Direct power off	20	
DISPLAY LANGUAGE	24	
DVI-D		
Control panel button	12	
Remote control button	14	
Terminal	13	
E		
ENTER		
Control panel button	12	
Menu navigation	27	
Remote control button	14	
F		
FILTER		
Compartment	13	
Indicator	12	
Indicator status	29	
Replacing	31	
FOCUS		
Adjusting	19	
Remote control button	14	
Focus ring	12	
Front leg adjusters	12	
FUNCTION		
Remote control button	14	
Remote control function	23	
I		
ID		
Remote control button	14	
Setting	15	
INPUT SELECT		
Control panel button	12	
Remote control buttons	14	
Remote control function	22	
INSTALLATION		
Projection method	16	
L		
LAMP		
Indicator status	28	
Lamp unit compartment	12	
LAMP1/LAMP2 indicators	12	
Replacing	30	
LAN		
Terminal	13	
LENS		
Control panel button	12	
Projection lens	12	
Projector lens cover	11	
Remote control button	14	
Lens home position	20	
M		
Mains lead		
AC IN terminal	13	
Accessories	11	
Connecting	18	
MENU		
CD-ROM	24	
Control panel button	12	
Navigation	27	
Remote control button	14	
Structure	24	
N		
Navigation buttons		
Control panel	12	
Navigation	27	
Remote control buttons	14	
Numeric (0 - 9) buttons		
Remote control buttons	14	
O		
ON SCREEN		
Remote control button	14	
Remote control function	22	
P		
POWER		
Switch	13	
Switching on/off	19	
Power cord secure lock		
Accessories	11	
Attaching	18	
POWER ON		
Control panel button	12	
Remote control button	14	
Switching on/off	19	
POWER STANDBY		
Control panel button	12	
Remote control button	14	
Projector lens cover		
Accessories	11	
R		
Remote control	14	
Accessories	11	
Signal receptor	12	
Signal receptor	12	
Wired connection	15	
REMOTE1		
Terminal	13	
Wired connection	15	
REMOTE2		
Terminal	13	

Index

RGB1	
Control panel button	12
Remote control button	14
Terminal	13

RGB2	
Control panel button	12
Remote control button	14
Terminal	13

S

Safety cable	
Accessories	11

SDI	
Control panel button	12
Remote control button	14
Terminal	13

Security lock	13
---------------------	----

SERIAL	
Terminal	13

SHIFT	
Adjusting	19
Adjustment range	20
Remote control button	14

SHUTTER	
Control panel button	12
Remote control button	14
Remote control function	22

Specifications	36
----------------------	----

STATUS	
Remote control button	14
Remote control function	23

S-VIDEO	
Control panel button	12
Remote control button	14
Terminal	13

T

TEMP	
Indicator	12
Indicator status	28

TEST PATTERN	
Remote control button	14
Remote control function	22

Troubleshooting	33
-----------------------	----

V

VIDEO	
Control panel button	12
Remote control button	14
Terminal	13

Z

ZOOM	
Adjusting	19
Remote control button	14

Panasonic Corporation

Web Site : <http://panasonic.net/avc/projector/>
© Panasonic Corporation 2009

Printed in Japan
S0209-1039B
TQBJ0296

