

geminini[®]

MDJ-500

PROFESSIONAL MEDIA CONTROLLER



USER MANUAL

Please read the manual carefully before operation!

WWW.GEMINISOUND.COM

PLEASE READ BEFORE USING APPLIANCE USING APPLIANCE IMPORTANT WARNING AND SAFETY INSTRUCTIONS!



CAUTION: This product satisfies FCC regulations when shielded cables and connectors are used to connect the unit to other equipment. To prevent electromagnetic interference with electric appliances such as radios and televisions, use shielded cables and connectors for connections. The exclamation point within an equilateral triangle is intended to alert the user to the presence of important operating and maintenance (servicing) instructions in the literature accompanying the appliance.

The lightning flash with arrowhead symbol, within an equilateral triangle, is intended to alert the user to the presence of uninsulated "dangerous voltage" within the product's enclosure that may be of sufficient magnitude to constitute a risk of electric shock to persons.

READ INSTRUCTIONS: All the safety and operating instructions should be read before the product is operated.

RETAIN INSTRUCTIONS: The safety and operating instructions should be retained for future reference.

HEED WARNINGS: All warnings on the product and in the operating instructions should be adhered to.

FOLLOW INSTRUCTIONS: All operating and use instructions should be followed.

CLEANING: The product should be cleaned only with a polishing cloth or a soft dry cloth. Never clean with furniture wax, benzine, insecticides or other volatile liquids since they may corrode the cabinet.

ATTACHMENTS: Do not use attachments not recommended by the product manufacturer as they may cause hazards.

WATER AND MOISTURE: Do not use this product near water, for example, near a bathtub, wash bowl, kitchen sink or laundry tub; in a wet basement or near a swimming pool; and the like.

ACCESSORIES: Do not place this product on an unstable cart, stand, tripod, bracket, or table. The product may fall causing serious injury to a child or an adult, and serious damage to the product. Use only with a cart, stand, tripod, bracket, or table recommended by the manufacturer, or sold with the product. Any mounting of the product should follow the manufacturer's instructions, and should use a mounting accessory recommended by the manufacturer.

CART: A product and cart combination should be moved with care. Quick stops, excessive force, and uneven surfaces may cause the product and cart combination to over-turn. See Figure A.

VENTILATION: Slots and openings in the cabinet are provided for ventilation and to ensure reliable operation of the product and to protect it from overheating, and these openings must not be blocked or covered. The openings should never be blocked by placing the product on a bed, sofa, rug, or other similar surface. This product should not be placed in a built-in installation such as a bookcase or rack unless proper ventilation is provided or the manufacturer instructions have been adhered to.

POWER SOURCES: This product should be operated only from the type of power source indicated on the marking label.

If you are not sure of the type of power supply to your home, consult your product dealer or local power company.

LOCATION: The appliance should be installed in a stable location.

NON-USE PERIODS: The power cord of the appliance should be unplugged from the outlet when left unused for a long period of time.

GROUNDING OR POLARIZATION:

- If this product is equipped with a polarized alternating current line plug (a plug having one blade wider than the other), it will fit into the outlet only one way. This is a safety feature. If you are unable to insert the plug fully into the outlet, try reversing the plug. If the plug should still fail to fit, contact your electrician to replace your obsolete outlet. Do not defeat the safety purpose of the polarized plug.
- If this product is equipped with a three-wire grounding type plug, a plug having a third (grounding) pin, it will only fit into a grounding type power outlet. This is a safety feature. If you are unable to insert the plug into the outlet, contact your electrician to replace your obsolete outlet. Do not defeat the safety purpose of the grounding type plug.

POWER-CORD PROTECTION: Power-supply cords should be routed so that they are not likely to be walked on or pinched by items placed upon or against them, paying particular attention to cords at plugs, convenience receptacles, and the point where they exit from the product.

OUTDOOR ANTENNA GROUNDING: If an outside antenna or cable system is connected to the product, be sure the antenna or cable system is grounded so as to provide some protection against voltage surges and built-up static charges. Article 810 of the National Electrical Code, ANSI/NFPA 70, provides information with regard to proper grounding of the mast and supporting structure, grounding of the lead-in wire to an antenna discharge unit, size of grounding conductors, location of antenna-discharge unit, connection to grounding electrodes and requirements for the grounding electrode. See Figure B.

LIGHTNING: For added protection for this product during a lightning storm, or when it is left unattended and unused for long periods of time, unplug it from the wall outlet and disconnect the antenna or cable system. This will prevent damage to the product due to lightning and power-line surges.

POWER LINES: An outside antenna system should not be located in the vicinity of overhead power lines or other electric light or power circuits, or where it can fall into such power lines or circuits. When installing an outside antenna system, extreme care should be taken to keep from touching such power lines or circuits as contact with them might be fatal.

OVERLOADING: Do not overload wall outlets, extension cords, or integral convenience receptacles as this can result in a risk of fire or electric shock.

OBJECT AND LIQUID ENTRY: Never push objects of any kind into this product through openings as they may touch dangerous voltage points or short-out parts that could result in a fire or electric shock. Never spill liquid of any kind on the product.

SERVICING: Do not attempt to service this product yourself as opening or removing covers may expose you to dangerous voltage or other hazards. Refer all servicing to qualified service personnel.

DAMAGE REQUIRING SERVICE: Unplug this product from the wall outlet and refer servicing to qualified service personnel under the following conditions:

- When the power-supply cord or plug is damaged
- If liquid has been spilled, or objects have fallen into the product.
- If the product has been exposed to rain or water.
- If the product does not operate normally by following the operating instructions. Adjust only those controls that are covered by the operating instructions as an improper adjustment of other controls may result in damage and will often require extensive work by a qualified technician to restore the product to its normal operation.
- If the product has been dropped or damaged in any way.
- When the product exhibits a distinct change in performance, this indicates a need for service.

REPLACEMENT PARTS: When replacement parts are required, be sure the service technician has used replacement parts specified by the manufacturer or have the same characteristics as the original part. Unauthorized substitutions may result in fire, electric shock or other hazards.

SAFETY CHECK: Upon completion of any service or repairs to this product, ask the service technician to perform safety checks to determine that the product is in the proper operating condition.

WALL OR CEILING MOUNTING: The product should not be mounted to a wall or ceiling.

HEAT: The product should be situated away from heat sources such as radiators, heat registers, stoves, or other products (including amplifiers) that produce heat.



Fig. A

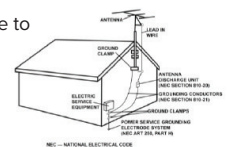

Fig. B

INTRODUCTION

Thank you for purchasing our Gemini MDJ-500. We are confident that the Gemini Family of products will not only make your life easier through the use of the latest technological advancements in cross-platform connectivity and sound reproduction but will raise the bar for DJ and pro audio products. With the proper care & maintenance, your unit will likely provide years of reliable, uninterrupted service. All Gemini products are backed by a 1-year limited warranty*.

PREPARING FOR FIRST USE

Please ensure that you find these accessories included with the MDJ-500:

- (1) Power cord
- (1) RCA cable
- (1) Operating instructions

PRECAUTIONS

- 1 Do not use this MDJ-500 at temperatures below 41°F/5°C or higher than 95°F/35°C.
- 2 This device should not be exposed to dripping or splashing, and no objects filled with liquids (such as drinks) should be placed on or near the device.
- 3 Place the unit in a clean and dry location.
- 4 Do not place the unit in an unstable location.
- 5 When disconnecting the power cord from the AC outlet, always grasp by the plug. Never pull the power cord.
- 6 To prevent electric shock, do not remove the cover or the bottom screws.
- 7 There are NO USER SERVICEABLE PARTS INSIDE. Please refer to a qualified technician.
- 8 Do not use chemical solvents to clean the unit.
- 9 Keep this manual in a safe place for future reference.

• In the USA- if you experience problems with this unit call Gemini customer service at 1 (732) 346-0061. Do not attempt to return this equipment to your dealer

WE WANT YOU LISTENING FOR A LIFETIME

Selecting fine audio equipment such as the unit you've just purchased is only the start of your musical enjoyment. Now it's time to consider how you can maximize the fun and excitement your equipment offers. This manufacturer and the Electronic Industries Association's Consumer Electronics Group want you to get the most out of your equipment by playing it at a safe level. One that lets the sound come through loud and clear without annoying blaring or distortion—and, most importantly, without affecting your sensitive hearing. Sound can be deceiving. Over time your hearing "comfort level" adapts to higher volumes of sound. So what sounds "normal" can actually be loud and harmful to your hearing. Guard against this by setting your equipment at a safe level BEFORE your hearing adapts.

To establish a safe level, start your volume control at a low setting. Slowly increase the sound until you can hear it comfortably and clearly, and without distortion. Once you have established a comfortable sound level, set the dial and leave it there. Taking a minute to do this now will help to prevent hearing damage or loss in the future. After all, we want you listening for a lifetime.

Used wisely, your new sound equipment will provide a lifetime of fun and enjoyment. Since hearing damage from loud noise is often undetectable until it is too late, this Manufacturer and the Electronic Industries Association's Consumer Electronics Group recommend you avoid prolonged exposure to excessive noise. This list of sound levels is included for your protection.

- 30 dB - Quiet library, soft whispers
- 40 dB - Living room, refrigerator, bedroom away from traffic
- 50 dB - Light traffic, normal conversation, quiet office
- 60 dB - Air conditioner at 20 feet, sewing machine
- 70 dB - Vacuum cleaner, hair dryer, noisy restaurant
- 80 dB - Average city traffic, garbage disposals, alarm clock at two feet

The following noises can be dangerous at extended exposure:

- 90 dB - Subway, motorcycle, truck traffic, lawn mower
- 100 dB - Garbage truck, chain saw, pneumatic drill
- 120 dB - Rock band concert in front of speakers, thunderclap
- 140 dB - Gunshot blast, jet plane
- 180 dB - Rocket launch pad

Information courtesy of the Deafness Research Foundation.

CLEANING THE UNIT

To clean the MDJ-500, use only a dry soft cloth and/or compressed air. If the unit is soiled with stubborn dirt, we suggest using a 2:1 solution of distilled water and 30% isopropyl alcohol. Avoid using harsh cleaning chemicals such as benzene, paint thinner, bleach, or hydrochloric acid, which will damage the unit.

OPERATING CONDITIONS

For optimum performance, the temperature of the operating environment should be between +5° C to +35° C (+41° F - +95° F). Failure to maintain proper operating temperature may result in difficulty reading the display, thermal overload, or systemwide instability. Avoid exposing the unit to direct sunlight.

When placing the unit in an installation, make sure that it is placed on a stable surface, as far away from vibrations as possible. Even though the unit is impervious to vibration, the storage devices (specifically hard drive based ones) that are designed to be used in conjunction with it are typically not. Also be sure not to place or use the player on heat generating sources, such as amplifiers or near spotlights.

PLAYABLE FORMATS

The MDJ-500 plays music files on USB storage devices. All of the following file formats are supported:

- WAV (16-bit PCM, sample rates of 8 kHz, 11.025 kHz, 12 kHz, 16 kHz, 22.50 kHz, 24 kHz, 32 kHz, 44.1 kHz, 48 kHz)
- MP3 (16 bit, 44.1 kHz, MPEG-I, Layer III)
- AAC (16 bit, 44.1 kHz, stereo, AAC Core, AAC Plus, AAC Plus v2)
- AIFF (16 bit, 44.1 kHz, stereo)

Supported file systems on USB Storage Devices include:

- FAT
- FAT32
- HFS+
- NTFS

USING MIDI CONTROL AND AUDIO

When placed in MIDI mode, the MDJ-500 can send MIDI data from the buttons and dials to a computer to control the parameters and playback controls of DJ software. The audio playback from the computer can also be output from the MDJ-500.

Before using the MDJ-500 as an audio device, connect the MDJ-500 with a USB cable and allow your PC/MAC to detect it. Open your DJ software and select the MDJ-500's output device in the DJ software's settings. For instructions on how to do this, see your DJ software's operating instructions.

CONNECTING TO A COMPUTER

The MDJ-500 is a plug and play device that requires no software installation. The MDJ-500's audio and MIDI drivers are compatible with PC and MAC.

- To use the MDJ-500 with a computer using Windows, connect the MDJ-500 to your PC after starting up the computer. The MDJ-500 will configure standard WDM drivers.

Select the MDJ-500 as your device to use it as your audio device. ASIO drivers can also be configured for use with the MDJ-500 and are available at geminisound.com

- To use the MDJ-500 with a computer using the OSX operating system, connect the MDJ-500 to your MAC after starting up the computer. Use the system's standard Core Audio drivers and select the MDJ-500 as the device.

UNIT OVERVIEW

TOP VIEW

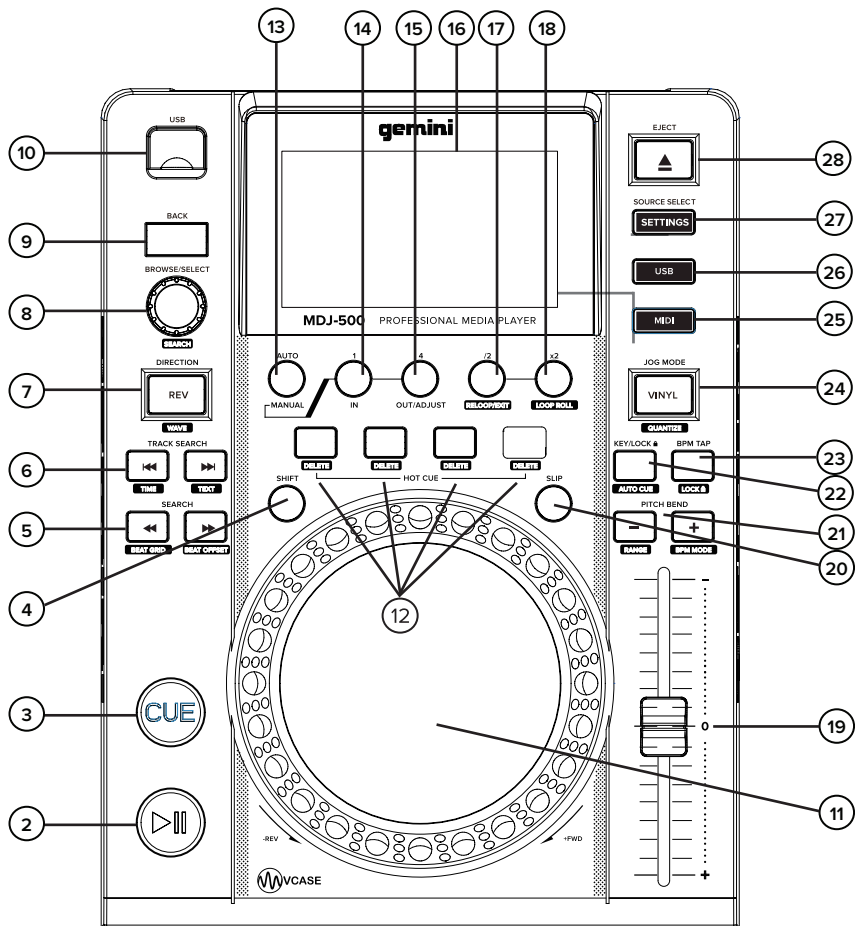

REAR VIEW

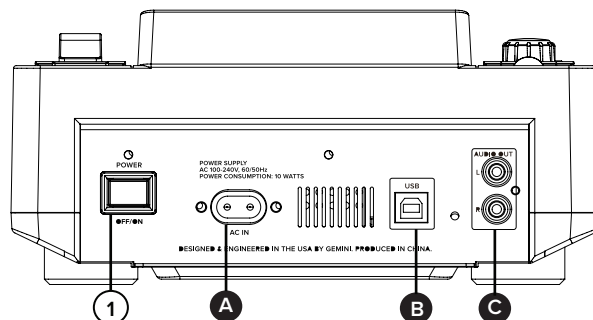

- | | | |
|--|--|--------------------|
| ① Power | ⑬ Auto / Manual Loop | ⑳ Vinyl (Quantize) |
| ② Play/Pause ▶ / II | ⑭ Auto Loop 1 Beat / Manual Loop IN | ㉑ MIDI Select |
| ③ Cue | ⑮ Auto Loop 4 Beat / Manual Loop OUT | ㉒ USB Select |
| ④ Shift | ⑯ 4.3"LCD Screen | ㉓ Settings |
| ⑤ Search ◀▶▶ (Beat Grid / Beat Offset) | ⑰ Loop / 2 (Reloop / Exit) | ㉔ Eject Media |
| ⑥ Track Search ◀▶▶ (Time / Text) | ⑱ Loop x 2 (Loop Roll) | |
| ⑦ Reverse (Wave) | ㉑ Tempo Slider | |
| ⑧ Browse / Select (Search) | ㉒ Slip Mode | |
| ⑨ Back | ㉓ Pitch Bend [+][-] (Range / BPM Mode) | |
| ⑩ USB | ㉔ Keylock (Autocue) | |
| ⑪ Jog Platter | ㉕ BPM Tap (Lock BPM) | |
| ⑫ Hot cues 1-4 (Delete Cue) | | |

CONNECTING THE MDJ-500

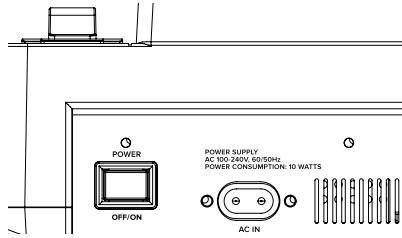

POWER

Plug the 2 prong power cable into the power input on the back of the MDJ-500 (A), and the other end into Mains power.

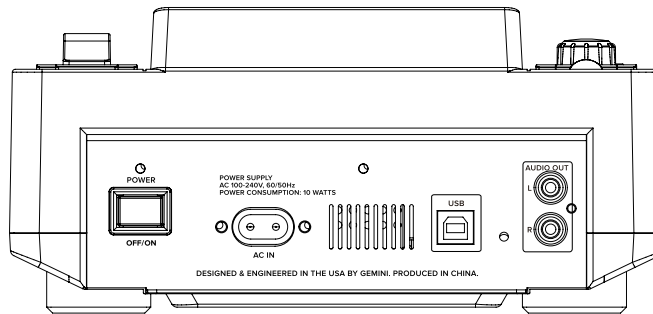

LINE OUTPUT

Plug one end of the included RCA cable into the LINE OUTPUT JACK (D) on the rear panel.

Plug the other end of the RCA connectors into any available line input jacks on your mixer.

If you are connecting the MDJ-500 through a receiver, you can plug the RCA connectors into the CD AUX INPUT JACKS on your receiver. If there are no CD or AUX INPUTS use any line level (not phono) inputs.

USB

Plug in the USB cable into the USB OUT (B) on the rear panel. Plug the other end of the USB cable into any available USB port on your computer. This will enable you to use the MDJ-500 in MIDI mode

DISPLAYS

DISPLAYS

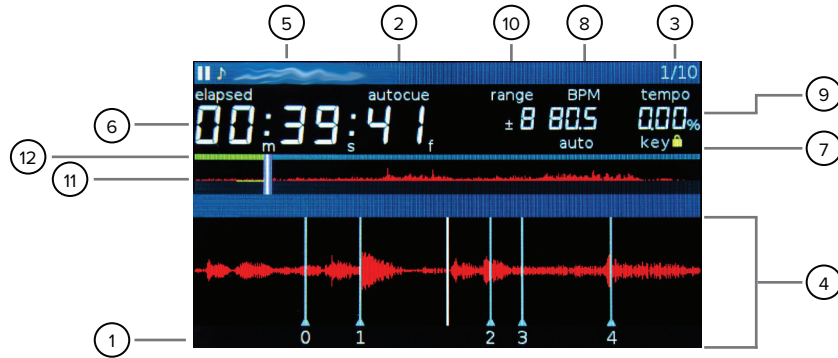

- ① **CUE**
Shows the position of hot cue points
- ② **AUTOCUE**
This appears when auto cue has been enabled in settings
- ③ **TRACK NUMBER**
This indicates the track number, and the remaining tracks in the current folder
- ④ **INFORMATION DISPLAY SECTION**
The large waveform, beat grid, and loop area is shown here. When in browse mode, a list of songs is shown
- ⑤ **TRACK NAME**
Track name and other song data is shown here
- ⑥ **TIME DISPLAY**
Remaining or Elapsed time is shown here in minutes, seconds, and frames (75 frames per second)
- ⑦ **KEYLOCK**
This appears when the keylock is engaged.
- ⑧ **BPM**
Displays the BPM of the track currently loaded
- ⑨ **TEMPO**
Displays the current position of the pitch fader
- ⑩ **RANGE**
Indicates the range in which the tempo can be adjusted
- ⑪ **WAVE DISPLAY**
This displays the full song wave display. The white line indicates the current position of the track, while blue markers show hotcues and a green waveform highlight indicates a stored loop.
- ⑫ **PROGRESS BAR**
Indicates the progress of the current playing song. When elapsed time is displayed the left edge of the graph lights green to show how much of the song has elapsed. When remaining time is displayed the right side of the graph lights green to show the remaining time.

OTHER SCREEN MESSAGES –

- **MSD READ ONLY** – Indicates that the inserted media is not writable
- **SLIP ON/OFF** – Tells you when the Slip feature is active
- **LOOP ROLL ON / OFF** – Lets you know when the Loop Roll feature is on or off.
- **EMERGENCY LOOP** – When the Emergency Loop feature is enabled in Settings, this will let you know when an Emergency Loop is active.

Once you have connected all your cables, you can turn the MDJ-500's power on by pressing the POWER (1) button. Pressing the button again will turn the unit off.

LOADING MEMORY DEVICES

SOURCE SELECT

USB

Pressing the USB source button allows you to play music from a USB device. (Default selection)

MIDI

Pressing the MIDI source button switches the unit to MIDI / HID mode with bi-directional support. In this mode, all controls (button pressings, pitch potentiometers moving and wheel rotations) are registered on the unit and transferred to PC via USB MIDI. This can be used in conjunction with software to control the software's parameters. The MDJ-500 is also capable of receiving data from software that can drive information on its screen (The VirtualDJ software by Atomix offers native support for the MDJ-500 and allows MIDI control, USB audio, and screen support).

LOADING/EJECTING USB DEVICES

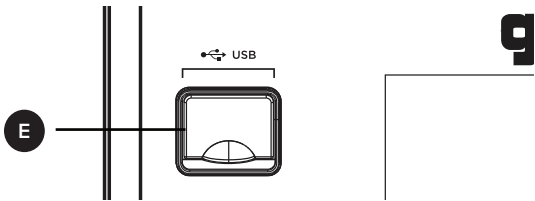

Insert the USB storage device into the USB input (E) on the top of the MDJ-500. Upon loading the device, the LCD display will show the folders and tracks on the USB storage device.

To eject the USB drive, press EJECT or MIDI and remove the USB storage device.

*NOTE: Before powering off the MDJ-500, it's a good idea to remove any connected USB storage device

BROWSING TRACKS/FOLDERS

Turning the browse knob (8) activates the browse screen. The browser shows the available files and folders on the USB storage device.



Rotating the browse encoder (8) allows searching through the browser.

To open a folder, highlight a folder and push the encoder (8) to select. To load a track, highlight a track to load and push the encoder (8) again.

To return to the previous folder, press the back (9) button.

Once you have loaded a track, the TRACK TITLE on the LCD Screen will display the loaded track.

Once you have loaded a track, the TRACK TITLE on the LCD Screen will display the loaded track. You can return to the main screen without loading a track but pressing and holding the back (15) button.

PLAYBACK CONTROLS

PLAY/PAUSE

Pressing PLAY/PAUSE (2) will begin playback of the selected track. Pressing PLAY/PAUSE (2) again will pause playback and hold the track at the current position.

MASTER CUE CONTROLS

SETTING A MASTER CUE POINT

While the unit is in playback, press PLAY/PAUSE ► / II (2) to pause the track. While the track is paused, press CUE (3) to set the cue point at the current position.

ADJUSTING THE MASTER CUE POINT

After the cue point has been programmed, press PLAY/PAUSE (2) to pause the track at the cue point. Press SEARCH (5) or rotate the jogwheel to adjust the cue position. Press CUE (3) to set the cue point at the play marker.

RETURNING TO THE MASTER CUE POINT

While the unit is playing and after the cue point has been programmed, pressing CUE (3) will cause the unit to enter the PAUSE mode at the programmed cue point. Holding down the CUE button changes the function to preview, and allows you to stutter start or play from the programmed CUE POINT. Releasing the CUE button will return the track to the preset CUE point. You can press the PLAY/PAUSE button while holding the CUE button to allow playback to continue from the current position.

AUTO CUE

The AUTO CUE (22) function sets the Master Cue at the point immediately before sound starts, skipping the beginning silent section of tracks. Press shift and keylock (22) to enable auto cue. The audio level threshold determines where the auto cue is set, and can be adjusted in Settings>Autocue Level.

SEARCH

Pressing SEARCH FORWARD (5) will fast-search through the track in the forward direction, and holding SEARCH BACK (5) will fast-search through the track in the reverse direction.

TRACK SEARCH

Pressing TRACK SEARCH FORWARD (6) will advance to the beginning position of the next track. Pressing TRACK SEARCH BACK (6) will return the current track to the beginning position.

PITCH BEND

Pressing the PITCH BEND - / + (21) will temporarily raise or lower the pitch from the existing pitch setting. Releasing the buttons will return the pitch to the original setting.

ADJUSTING TEMPO

The tempo increases when the tempo slider [19] is moved to the [+] side (down), decreases when moved to the [-] side (up). The rate at which the playing speed is changed is indicated on the LCD display.

PITCH RANGE

Pressing shift and pitch bend - (21) toggles the range between +/- 4%, 8%, 16%, 24%, 50% and 100%.

KEY LOCK

KEY LOCK (22) allows the user to adjust the tempo (speed) of the song without causing a noticeable change in pitch.

BPM

Pressing shift and pitch bend + (21) button allows the user to toggle through the different BPM modes: ID3 / AUTO / MANUAL / TAP.

BPM TAP - When BPM mode is set to TAP, the BPM TAP (23) button can be used to set the BPM of the loaded track. BPM is calculated through a rolling average, with each tap increasing the accuracy. To re-start the calculation, don't touch the BPM TAP button for 2 seconds.

MANUAL BPM - When BPM mode is set to MANUAL, the browse knob (8) can be used to set the beats per minute of playback by rotating to the desired tempo. Hold shift and turn the browse knob for fine control. Press the browse knob to set the new BPM.

ID3 - when BPM mode is set to ID3, the BPM information from the ID3 tag will be displayed.

AUTO BPM - When BPM mode is set to AUTO BPM, the beats per minute are calculated automatically and corresponding info is displayed on screen.

NOTE: If a BPM value is present in file info ID3 tag, the value is loaded into the unit and displayed.

BPM LOCK

The BPM LOCK feature allows the user to lock the BPM of all songs to a specific value. To use, enable the feature by pressing shift and BPM Tap buttons. By default, the BPM value will change to the BPM of the current song. To change this value, turn the browse knob to the desired value and press the browse knob to set. All songs played from your MDJ-500 will now be at the selected tempo.

To turn off, press shift and BPM TAP again.

PLAYBACK CONTROLS

HOTCUES 1-4

SETTING HOT CUES

During playback or in pause mode, press HOT CUE 1, 2, 3 or 4 (12) at the point in the track where the HOT CUE is to be set. Once pressed, the programmed HOT CUE (1, 2, 3 or 4) should now be illuminated. To delete a hot cue, press shift (4) and select the hot cue to be deleted.

PLAYING HOT CUES

During playback or in pause mode, press HOT CUE 1, 2, 3 or 4 (12) and playback starts instantaneously from the point recorded on that HOT CUE.

LOOP CONTROLS

SETTING A MANUAL LOOP

During playback, press LOOP IN (14) at the desired starting position for the loop (loop in point). Press LOOP OUT / ADJUST (15) at the desired ending position for the loop (loop out position). The loop out point is now set, and loop playback starts from the loop in point.

ADJUSTING A LOOP

To adjust the loop once the loop is set, press the IN (14) button to adjust the in point or press the OUT / ADJUST button to adjust the out point. The length of the loop can be adjusted by rotating the jogwheel (11) to move the loop point. When the loop points are correct, press the IN or OUT button to set and exit. Press the /2 button to half the size of the loop, press the x2 button to double the size of the loop.

CANCELING A LOOP

While the loop is engaged, press RELOOP/EXIT (17) to disengage the loop. Playback continues after the loop out point.

RETURNING TO A LOOP

After canceling a set loop, press RELOOP/EXIT (17) during playback to reengage the last set loop. Loop playback begins at the loop in point.

SHRINKING OR EXTENDING A LOOP

Once a loop is active, it is possible to double or halve its size by using the "/2" and "x2" buttons (SHIFT + IN or OUT/ADJUST buttons). This can be used (for instance) to create breakdowns and drops in songs.

AUTO BEAT LOOP

Press any of the AUTO LOOP buttons (14 and 15) to set a 1 or 4 beat loop. The corresponding button will light up when the loop is active. Auto beat loops are set based on current BPM of track.

AUTO LOOP ROLL

Press shift and the x2 button (18) to activate loop roll mode. Press and hold any of the AUTO LOOP buttons to set a loop to your desired length with slip mode activated. Release to exit the loop and turn off slip mode.

JOGWHEEL CONTROLS

VINYL MODE

Pressing the VINYL (24) button enables VINYL mode. Enabling VINYL mode allows scratching when the JOGWHEEL (11) is touched and rotated. When VINYL mode is disabled, the JOGWHEEL (11) will be in SEARCH MODE and will allow searching through the track.

PITCH NUDGE

It is possible to increase or decrease the pitch temporarily by up to 8% by using the platter. If the platter is in VINYL mode, then a pitch nudge can be done by turning the platter by touching only the outer (rubber) edge. If VINYL MODE is off, then you can turn the platter from anywhere (including the top) to nudge the pitch.

REVERSE MODE

Pressing the REV (7) button causes the playback to run in reverse direction at the same speed as the forward playback.

SLIP MODE

When SLIP (20) is enabled, normal playback continues inaudibly underneath SCRATCH, LOOP, and REVERSE effects. When SCRATCH, LOOP, or REVERSE mode is exited, normal playback resumes from the inaudible playback spot.

SLIP WITH SCRATCH

To use SLIP while scratching, enable VINYL mode by pressing the VINYL (24) button. Enable SLIP mode by pressing the SLIP (20) button. Using the jog dial will now create scratch effects while normal track playback continues inaudibly underneath. Once the jogwheel is released, track playback will continue from the playback position playing underneath.

SLIP WITH LOOP

To use SLIP with loop playback, enable SLIP mode by pressing the SLIP (20) button. Set a loop using the IN / OUT controls and loop playback will begin. The SLIP (20) button will begin flashing indicating SLIP mode is active and the position playing underneath is shown on the jogwheel display. Upon exiting the loop, track playback will continue from the playback position playing underneath.

PLAYBACK CONTROLS

SLIP WITH REVERSE

To use SLIP with reverse playback, enable SLIP mode by pressing the SLIP (20) button. Press REVERSE (7) to begin playback in the reverse direction. The SLIP (20) button will begin flashing indicating SLIP mode is active and the position playing underneath is shown on the jogwheel display. Press REVERSE (7) again to exit reverse playback. Upon exiting reverse playback, track playback will continue from the playback position playing underneath.

Reverse in Slip mode can also be used as a Censor feature.

BEAT GRID

The MDJ-500 is able to generate a beat grid by either internal analysis or track analysis done in VCase. A beat grid is used to align events to beats in the track. Turning the beat grid on or off can be done by holding shift (4) and pressing SEARCH – (5), or via SETTINGS (27). It is highly recommended that you use VCase to analyze your music to create the most accurate beat grids possible.

BEAT OFFSET

This allows the user to move the beat grid to the play marker. It is used to align the beat grid to a specific beat in the track (creating a kind of “anchor” for the beat grid). To use BEAT OFFSET, first move the play marker to the event you would like to snap the beat grid to. Then hold shift (4) and press the SEARCH + button (5).

If you find that you are not able to adjust the beat offset, try enabling it in the SETTINGS menu.

QUANTIZE

Once a beat grid is set, the quantize feature allows you to “snap” events to the beat grid. With quantize on, loop markers, cues, etc will all align to the closest beat marker, even if you aren't quite perfect.

To turn quantize on, press and hold shift (4) and press the vinyl button (24). You will see the word QUANTIZE in the LCD display, indicating the feature is active. You can also turn on quantize from the SETTINGS menu.

BROWSER MODIFIERS

WAVE

The WAVE feature allows you to zoom into the waveform of the selected track. To cycle through the available views, hold the shift button (4) and press the REV button (7). Multiple presses will toggle through different zoom levels.

TIME FORMAT

TIME FORMAT toggles the display between ELAPSED or REMAINING time. This feature can either be accessed by holding shift and pressing the TRACK SEARCH + button (6), or through the SETTINGS menu.

TEXT DISPLAY

This feature allows the user to select what information shows up at the top of the display for the loaded track. To change this setting, hold the shift button (4) and press the TRACK SEARCH + button (6). At the top of the LCD screen, the information will change between the following parameters on each press...

- Song Name
- Artist Name
- Album Title
- Genre

DATABASE SEARCH

The MDJ-500 is capable of creating a searchable database for any attached USB drive. Once created, this database can be used to search the USB drive using a number of modifiers. And the database is carried on the USB drive itself, so it is always available for any Gemini device.

To create the database, hold shift and press the browse knob (8). You will be asked if you would like to create the SearchDB. Once you've answered yes, a progress bar will appear while the USB drive is indexed.

Once indexing is completed, search is available by FILENAME, ARTIST, ALBUM, TITLE, and GENRE. Turn the browse knob to choose your search parameter, then push to select.

From there, you will be able to select alphanumeric characters to search through the tracks. To back out of results to search with a different alphanumeric character, press the back button (9).

If you would like to change your search field (for instance, from FILENAME to TITLE), hold shift and turn the browse knob.

If you add or remove music from your USB storage device. It's a good idea to also update your SearchDB. To do this, just hold shift and press the browse knob again. You will be asked if you would like to update your database or use the existing. Choose update and let the MDJ-500 re-index your drive.

MIDI CONTROLS

MIDI MODE

The MDJ-500 has MIDI mode, which allows the data from the buttons and dials of the MDJ-500 to be encoded into MIDI format. If the unit is connected via a USB cable to a computer with MIDI-compatible DJ software, the DJ software can be operated from the unit. The computer audio can also be played from the MDJ-500's audio outputs. It may not be possible to use some buttons to operate the DJ software.

HID MODE

In addition to MIDI, the MDJ-500 also uses HID protocol, which allows more verbose (and higher resolution) messaging. If your software supports HID devices, disable MIDI devices in your software and search for HID devices. This should locate the MDJ-500 and allow you to use it as an HID device.

CONFIGURING MIDI MODE

MIDI CHANNEL

It is possible that you will need to change the MIDI channel your MDJ-500 is using – either to gain compatibility with software or to resolve a conflict with another connected MIDI device.

To change the MIDI channel, make sure that you have the USB source selected, then press **SETTINGS** (27). Scroll down to the entry called **MIDI CHANNEL**. Press the browse knob to select that entry, then turn the browse knob to select the desired channel (0-15 are available). Once you've selected the correct MIDI channel, press the **BACK** button to exit Settings.

NOTE: In Settings, the MIDI channels are presented in hexadecimal. If your software defines the MIDI channel in decimal, just add 1 (so if Settings says channel "0" is selected, that is channel "1", and so on).

After configuring the MIDI settings on the MDJ-500, start the DJ software:

- Select the MDJ-500 as your MIDI device*
- Select the MDJ-500 as your AUDIO device*

*Refer to DJ software's instructions

SOUND CARD

The MDJ-500 USB audio interface has the following bit depth / sample rate options available...

- 24-bit/192kHz
- 24-bit/96 kHz
- 24-bit/48 kHz
- 16-bit/48kHz
- 16-bit/44.1 kHz

To change these settings, press the USB source select button (26), and then press the **SETTINGS** button (27). Scroll down to the **SOUND CARD** entry, press the browse knob to select, turn to select one of the available options, and press the browse knob again to activate that setting.

NOTE: Higher bit depth and sampling rates will create greater latency and may impact performance.

SETTINGS

- 1 - Press the SETTINGS button (27) to see the settings screen.
- 2 - Use the browse knob (8) to select the settings item.
- 3 - Set the cursor to the item you want to change, then press the browse knob.
- 4 - Turn the browse knob to highlight the setting you want.
- 5 - Press the browse knob to enter the setting. Press the back button to abort the change.
- 6 - Press back to exit the settings menu.

SETTINGS PREFERENCES

(Default in bold)

Options Settings	Settings Range	Description
Current Song BPM	Normal , *2, /2	Allows user to correct double or half BPM analysis errors
AutoCue	On , Off	Sets the master cue point at the first audible level
AutoCue Level	-36dB , -42dB, -48dB, -54dB, -60dB, -66dB, -72dB	Sets Autocue detection level
Eject / Load	Lock , Unlock	Lock media when playing
Time Format	Elapsed , Remain	Show elapsed or remaining time
Pitch / Tempo Range	4%, 8% , 16%, 24%, 50%, 100%	Sets pitch/tempo range
Keylock	On, Off	Turns on Keylock
BPM Mode	Auto , Tap, ID3, Man	Selects BPM mode
BPM Lock	Value, Off	Sets BPM Lock on or off
Beat Grid	On, Off	Shows beat grid on waveform
Quantize	On, Off	Turns Quantize on or off
Beat Offset	On, Off	Allows manual adjustment of beat grid
Emergency Loop	On, Off	Creates 4 beat loop when usb stick is removed
Sound Card	44/16, 48/16 , 48/24, 98/24	Sets sound card setting
MIDI Channel	0-15	Sets MIDI Channel
Vinyl Mode	On, Off	Turns Vinyl (scratch) mode on or off
Platter Nudge	1 , 2, 3, 4, 5	Determines platter nudge sensitivity
Load Settings from MSD		Loads stored settings off mass storage device
Save Settings to MSD		Save settings to mass storage device
Reset Settings		Reset settings to default values
Software Version		Current software version
Exit		Exit the menu

Settings are stored and loaded from the USB storage device when one is connected. To manually set or recall your settings, use the “Load Settings from MSD” or “Save Settings to MSD” features from your settings page in the MDJ-500. The Gemini VCase software can also create and set settings data. This allows you to configure one device the way you want it, then export those settings to your other MDJ devices.

TROUBLESHOOTING / SPECIFICATIONS

TROUBLESHOOTING

USE STORAGE DEVICE ERRORS

Some USB devices may not operate properly with the MDJ-500. Gemini accepts no responsibility for any possible data loss that may occur. To ensure that data is not permanently lost, please make sure to backup any data prior to connecting the USB device to the unit.

- USB hubs cannot be used with the MDJ-500.
- If the unit does not read the USB storage device, first check to see if the drive was inserted completely.
- If a **“ERR E-1006 Too many devices”** message appears, it is because a USB hub is in use. The MDJ-500 does not work with USB hubs. Disconnect the USB hub and connect the USB storage device directly into the MDJ-500.
- If a **“ERR E-1003 Media error”** message appears, this signifies that your USB storage device is formatted incorrectly.
- If you receive any of the following errors, please contact Technical Support...

ERR E-1001 Bad Update
ERR E-1004 Unsupported file format
ERR E-1007 Incorrect processing

MIDI ERRORS

- If the computer does not recognize the device, try powering the unit off and rebooting the computer.
- If the DJ software does not list the device, ensure that you are using the latest version by downloading any updates to your DJ software. If the MDJ-500 mapping does not appear in your DJ software’s list, go to geminisound.com for downloads and support.

GENERAL TROUBLESHOOTING

Make sure your MDJ-500 is running the latest firmware! Visit www.geminisound.com to download and run the Gemini Updater software

SPECIFICATIONS

GENERAL

Type.....USB media player w/ MIDI and HID
USB output type.....Type B
Power Supply.....AC 100/240V, 60/50 Hz
Power consumption.....10W
Dimensions.....13.125 x 12 x 4.5 inches
(333 3/8 x 304 x 114.3 mm)
Weight..... 7.2 lbs. (3.3 kg)

ANALOG AUDIO

Frequency Response.....20 Hz to 20 kHz
Total Harmonic Distortion.....Less Than 0.05%
Signal to Noise Ratio.....< 100dB
Dynamic Range..... > 100dB
Output Level.....1.0 +/- 0.2V R.M.S.

USB AUDIO

Bit Depth.....24-bit, 16-bit
Sampling rate.....192kHz, 96kHz, 48kHz, 44.1kHz

SPECIFICATIONS AND DESIGN ARE SUBJECT TO CHANGE WITHOUT NOTICE FOR PURPOSE OF IMPROVEMENT.

**IN THE USA: IF YOU ARE EXPERIENCING PROBLEMS WITH THIS UNIT
CALL 1-732-346-0061 FOR INNOVATIVE CONCEPTS AND DESIGN LLC CUSTOMER SERVICE.
DO NO ATTEMPT TO RETURN THIS EQUIPMENT TO YOUR DEALER.**

Parts of the design of this product may be protected by worldwide patents. Information in this manual is subject to changes without notice and does not represent a commitment on the part of the vendor.

Innovative Concepts and Design LLC shall not be liable for any loss or damage whatsoever arising from the use of information or any error contained in this manual.

No part of this manual may be reproduced, stored in a retrieval system or transmitted, in any form or by any means, electronic, electrical, mechanical, optical, chemical, including photocopying and recording, for any purpose without the express written permission of Innovative Concepts and Design LLC.

It is recommended that all maintenance and service on this product is performed by Innovative Concepts and Design LLC or its authorized agents. Innovative Concepts and Design LLC will not accept liability for loss or damage caused by maintenance or repair performed by unauthorized personnel.

Worldwide Headquarters
107 Trumbull St. Building F8, 2nd Floor Elizabeth, NJ 07206 • USA
Tel: (732) 346-0061 • Fax: (732) 346-0065

gemini[®]

WWW.GEMINISOUND.COM

© Innovative Concepts and Design LLC 2015 All Rights Reserved .
