

INSTRUCCIONES MANUAL





Home Karaoke Party Speaker

GPK-800



DEAR CUSTOMER

In order to achieve the best performance of your product, please read this instruction manual carefully before using, and keep it for future reference.

CAUTION	
	RISK OF ELECTRIC SHOCK, DO NOT OPEN
	
Caution: To reduce the risk of electric shock do not open this device, there are no serviceable parts for customers. Please refer any maintenance or repair to qualified personnel.	
	This sign means the existence of dangerous voltage inside the unit, which states a risk of electric shock.
	This sign means that there are important instructions of operation and handling in the manual that comes with this device.

NOTE

This unit may be submitted for changes in specifications, characteristics and/or operation without prior notice to user, in order to continue improving and developing its technology.

Contents

1. Important Notice
 - Precautions
2. Your Party Speaker
 - Introduction
 - What's in the box
 - Overview of the Top control panel
 - Overview of the Rear panel
 - Overview of the Remote control

3. Get started
 - Connect power
 - Prepare the remote control
 - Turn on
4. Play
 - Basic key play operations
 - Play from USB
5. Listen to radio
 - Turn to FM radio stations
6. Connect with Bluetooth
7. Connect with AUX Line in
8. Connect with Wired Microphone
9. Production information
 - Specification
 - USB play ability information
10. Troubleshooting

1. Important Notice

Precautions

- ① Read these instructions.
- ② Keep these instructions.
- ③ Heed all warnings.
- ④ Follow all warnings.
- ⑤ Do not use this apparatus near water.
- ⑥ Clean only with dry cloth.
- ⑦ Do not block any ventilation openings.
Install in accordance with the manufacturer's instructions.
- ⑧ Do not install near any heat sources such as radiators, heat registers, stoves, or other apparatus (including amplifiers) that produce heat.
- ⑨ Only use attachments/accessories specified by the manufacturer.
- ⑩ Only use attachments/accessories specified by the manufacturer.
- ⑪ Use only with the cart, stand, tripod, bracket, or table specified by the manufacturer or sold with the apparatus. When a cart is used, use caution when moving the cart/apparatus combination to avoid injury from tip-over.

- ⑫ Unplug this apparatus during lightning storms or when unused for long periods of time.
- ⑬ Refer all servicing to qualified service personnel. Servicing is required when the apparatus has been damaged in any way. Such as power-supply cord or plug is damaged, liquid has been spilled or objects have fallen into the apparatus, the apparatus has been exposed to rain or moisture, does not operate normally, or has been dropped.
- ⑭ Battery usage CAUTION-TO prevent battery leakage which may result in bodily injury, property damage, or damage to the remote control.
 - Install all batteries correctly, + and - as marked on the remote control.
 - Do not mix batteries (old and new or carbon and alkaline, etc.)
 - Remove batteries when the remote control is not used for a long time.

- Batteries (battery pack or batteries excessive heat such as sunshine, fire, or the like).
- ⑮ Apparatus shall not be exposed to dripping or splashing.
- ⑯ Do not place any sources of danger on the apparatus (e.g. liquid filled objects, lighted candles).
- ⑰ Where the MAINS plug or an appliance coupler is used as the disconnect device, the disconnect device shall remain readily operable.



Warning

- Never remove the casing of this apparatus.
- Never lubricate any part of this apparatus.
- Never place this apparatus on other electrical equipment.
- Never look into the laser beam inside this apparatus.
- Make sure that you always have easy access to the power cord, or adaptor to disconnect the apparatus from the power.



Caution

- Use of controls or adjustment or performance of procedures other than herein may result in hazardous radiation exposure or other unsafe operation.

Hearing safety



Listen at a moderate volume.

- Using headphones at a high volume can impair your Hearing.
- Sound can be deceiving. Over time your hearing 'comfort level' adapts to higher volumes of sound. so after prolonged listening. What sounds 'normal' can actually be loud and harmful to your hearing. To guard against this, set your volume to a safe level before your hearing adapts and leave it there.

To establish a safe volume level:

- Set your volume control at a low setting.
- Slowly increase the sound until you can hear it comfortably and clearly. Without distortion.

Listen for reasonable periods of time:

- Prolonged exposure to sound, even at normally 'safe' levels, can also cause hearing loss.
- Be sure to use your equipment reasonably and take appropriate breaks.

Be sure to observe the following guidelines when using your headphones.

- Listen at reasonable volumes for reasonable periods of time.
- Be careful not to adjust the volume as your hearing adapts.
- Do not turn up the volume so high that you can't hear what's around you.
- You should use caution or temporarily discontinue use in potentially hazardous situations. Do not use headphones while operating a motorized vehicle, cycling, skateboarding, etc., it may create a traffic hazard and is illegal in many areas.

Notice

- Any changes or modifications made to this device that are not expressly approved by Consumer Lifestyle may void the user's authority to operate the equipment.

2. Your Party Speaker

Introduction

With this unit, you can:

- Enjoy audio from USB storage Devices, and other external device;
- Listen to radio stations;
- Enjoy the music from your phone by bluetooth connecting;

What's in the box

Check and identify the contents of your package:

- Speaker
- Remote control
- User manual
- Aux In Cable
- FM Antenna Cable
- Power Cable

Overview of the Top control panel

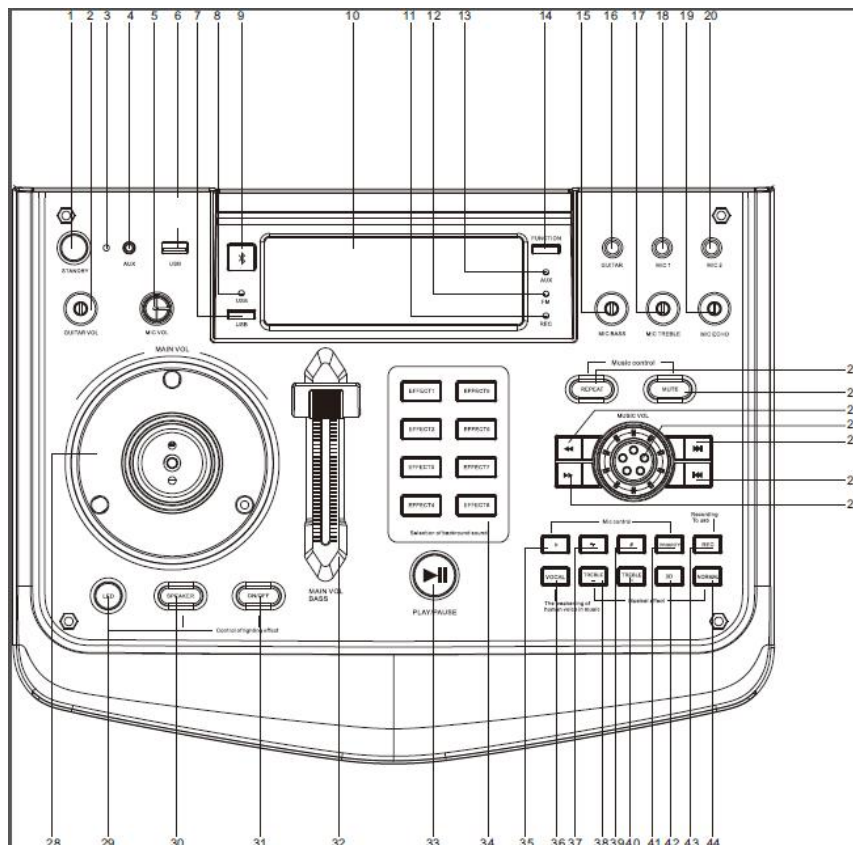

1. Standby Button
2. Guitar Volume Adjustment
3. Standby Function Indicator Light
4. AUX Insert Jack
5. Microphone Volume Adjustment
6. USB Insert Jack-1
7. USB Function Button
8. USB Function Indicator Light
9. Bluetooth Function Button
10. Display Window

11. REC Function Indicator Light
12. FM Function Indicator Light
13. AUX Function Indicator Light
14. Function Switching Button
15. Microphone Bass Volume Adjustment
16. Guitar Insert Jack
17. Microphone Treble Volume Adjustment
18. Microphone Insert Jack-1
19. Microphone Echo Volume Adjustment
20. Microphone Insert Jack-2
21. Repeat Button
22. Mute Button
23. Backward Button
24. Music Volume Control Rotary Knob
25. Next Track Button
26. Previous Track Button
27. Forward Button
28. Main Volume Control Rotary Knob
29. Disco LED Light Control Button
30. Speaker Light Control Button
31. ON/OFF Control Button
32. Bass Booster Volume Control
33. Play/Paush Button
34. 8 modes DJ Background Sound Effect
35. b Button (Falling tone button)
36. Vocal EQ Button
37. ↶ Button (Recovery tone button)
38. Treble Volume- Button
39. # Button (Rising tone button)
40. Treble Volume+ Button
41. Microphone Priority Button
42. 3D Button
43. REC Button
44. Normal Button

Overview of the Rear panel

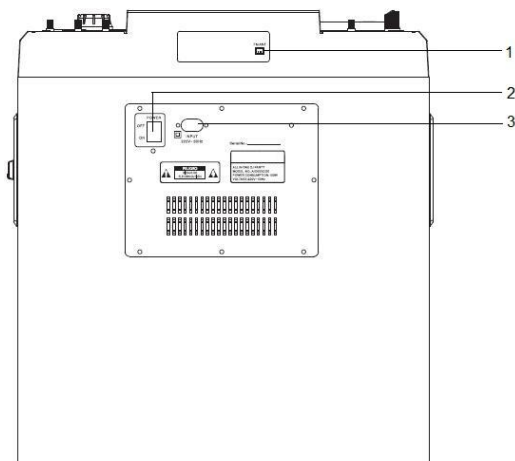

1. FM Antenna
2. Power ON/OFF switch button
3. AC Power Connect Inlet

Overview of the Remote control

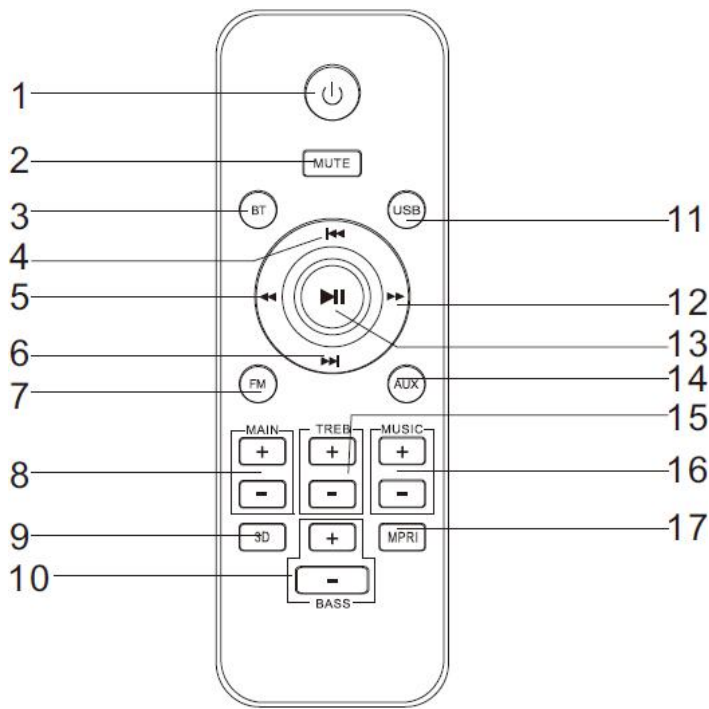

1. Standby button
2. Mute button
3. BT function button
4. Previous button
5. Backward button
6. Next button
7. FM function button
8. Main Volume +/-
9. 3D function button
10. Bass Volume +/-
11. USB function button
12. Forward button
13. Play /Pause button
14. AUX function button
15. Treble Volume +/-
16. Music Volume +/-
17. Microphone priority

3. Get started

Precautions

- Use of controls or adjustments or performance of procedures other than herein may result in hazardous radiation exposure or other unsafe operation.
- Always follow the instructions in this chapter in sequence.

Connect power



- Risk of product damage! Ensure that the power supply voltage corresponds to the voltage printed on back or the underside of the unit.
- Risk of electric shock ! When you unplug the AC power cord, always pull the plug from the socket. Never pull the cord.
- Before you connect the AC power cord, make sure that you have completed all other connections.

Connect the power cable to the wall socket:

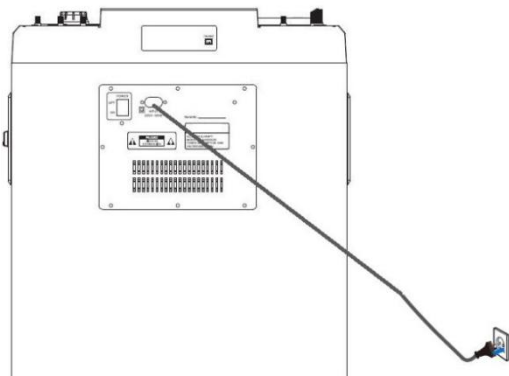

Prepare the remote control

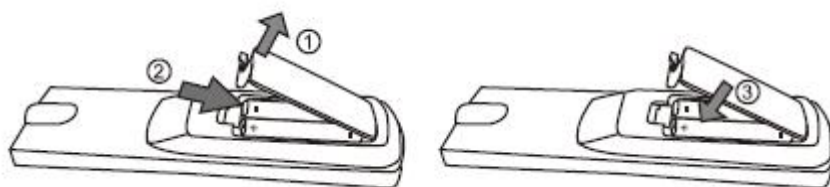

To insert the remote control batteries:

1. Open the battery compartment.
2. Insert 2 x AAA batteries with correct polarity (+/-) as indicated. The 2xAAA battery not include in our products, please purchase from Authorized Seller.
3. Close the battery compartment.

Please Note:

- If you are not going to use the remote for a long time, remove the batteries.
- Do not use old and new or different type of batteries in combination.
- Batteries contain chemical substances, so they should be disposed of properly.

Turn On

1. Connect the AC power cable and plug to the wall socket;
2. Press the "POWER" key on the rear panel and switch "POWER" button to "ON" position;









Caution:



















If you do not use this unit for a while, please press the "POWER" button on the rear panel and switch "POWER" button to "OFF" position, and disconnect the AC power of this unit.











4.Play

Basic key play operations

You can control play through following operations.

Key	Function
	Press STANDBY button to power on or off the speaker
	Insert the Aux in cable to AUX jack to connect to the external device
	Insert the USB device to USB jack to play music
	Turn GUITAR VOL knob to adjust the sound level of guitar
	Turn MIC VOL knob to adjust the sound level of microphone
	Bluetooth function switching Button
	USB function switching Button
	Function switching Button (switch between





	Insert the 6.3 Guitar to the GUITAR jack
	Insert the 6.3 wired microphone to the MIC1 / MIC2 jack
	Turn MIC BASS knob to adjust the bass sound level of microphone
	Turn MIC TREBLE knob to adjust the treble sound level of microphone
	Turn MIC ECHO knob to adjust the echo sound level of microphone
	Turn MAIN VOL knob to adjust the sound level (This knob controls the sound of all source, means when the speaker is playing the music and insert the microphone, then you can turn this knob to control the sound level of music and microphone.)
	Disco LED Light control button Press this “ LED ” button to switch the different running effect.
	Speaker Light Control Button Press this “ SPEAKER ” button to switch the different light effect of the speakers. Note: The speaker light color default as random colorful switching when power on the speaker; and can press this button for the speaker light color select.
	Light ON/OFF control Button Press this button to turn on or off the Disco Light and Speakers Light.
	Bass Booster Volume Control Push the booster volume control to adjust the sound level of bass.
	Selection of background sound Button There are eight effect to select.
	Play/Pause Button Notes: when the unit on FM mode, press this button for a few seconds can search and save the station automatically.
	Repeat Button There are two repeat modes can be selected : one or all.
	MUTE Button 1.Press this button for mute function. 2.Press mute button for about 3 seconds can turn on the voice prompt function, the display will show “ V-ON ”. 3.When the speaker on V-ON mode, press mute button for about 3 seconds can turn off the voice prompt function, the display will show “ V-OFF ”.
	Backward Button
	Forward Button
	Music Volume Control (This rotary music control only control the volume of the music currently playing, and also you can turn MAIN VOL to increase the volume.)
	Press this button to next track
	Press this button to previous track

	<p>b Button</p> <ol style="list-style-type: none"> 1. Press this button to switch to the falling tone when using the microphone. 2. Press one time for one level, there are 12 levels can be selected.
	<p>VOCAL Button</p> <p>Press this button for the weakening of human voice in music.</p>
	<p>Recovery Button</p> <p>Press this button to recovery the tone from b or # when using the microphone.</p>
	<p>Treble Volume- Button</p> <ol style="list-style-type: none"> 1.Press this button to increase treble volume level when playing music. 2.Press one time for one level, there are 7 levels can be selected.
	<p># Button</p> <ol style="list-style-type: none"> 1.Press this button to switch to the rising tone when playing music 2.Press one time for one level, there are 12 levels can be selected.
	<p>Treble Volume+ Button</p> <ol style="list-style-type: none"> 1.Press this button to decrease treble volume level when playing music. 2.Press one time for one level, there are 7 levels can be selected.
	<p>MIC PRIORITY Button</p> <p>Press this button to open the microphone priority when using the microphone.</p>
	<p>3D Button</p> <p>Press one time to turn on the 3D surround sound effect when playing music, press again to turn off the effect.</p>
	<p>REC Button</p> <ol style="list-style-type: none"> 1.Press this button can record the music sound of Bluetooth/FM/Microphone/AUX to USB when playing music. 2.Press one time to open the recording and the music of Bluetooth/FM/Microphone/AUX will store automatically into USB. 3.Press again to stop the recording and you can play the recorded music from the USB. <p>Note: USB music can not record to USB.</p>
	<p>NORMAL Button</p> <p>Press this button to resume the treble volume as 0 when playing music.</p> <p>Notes: when press NORMAL button to resume the treble volume, the 3D surround sound effect function will turn on, you can press 3D button to turn off if you do not need this effect.</p>

Play from USB

Make sure that the USB storage device contains playable audio contents for supported formats.

Instruction:

- 1.Insert the USB storage device into the “USB ” jack on the top panel can play automatically.
- 2.Press  or FUNCTION button to switch to USB mode when at other mode, the USB indicator light will light on.
3. Press  or  key to select.
- 3.Press  key to play or pause.

Important:

USB socket is only for music playing, not support charging.

The MAX memory size of USB:16G

5.Listen to radio

Turn on FM radio stations

- Make sure that you have connected and fully extended the supplied FM antenna.

Instructions:

1. Insert the FM Antenna Cable to the FM ANT jack on the rear panel.
2. Press FUNCTION button on the Top Control panel or press FM key on the remote control to switch to FM mode.
3. Once switch successfully, the FM indicator light will light on.
4. Press ►|| key on the top control panel or on the remote control to search and save the radio stations automatically.
5. Press ◀◀ / ▶▶ to select programmed radio stations.

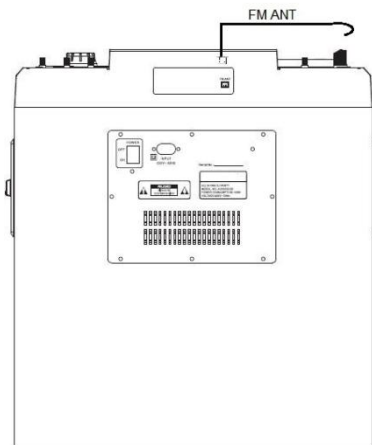

6. Connect with Bluetooth

Instructions:

1. Press  button or "FUNCTION" button on the top control panel or press BT button on the remote control to switch to the BLUETOOTH connect mode, (bLUE) will be displayed on the display screen.
2. Open the Bluetooth on your external device (must have Bluetooth function), and the name "AIO003OI20" will show on the external device, please try to connect it.
3. Once connected, you can hear a small sound from the speaker.
4. You can use the ◀◀ or ▶▶ key on the top control panel to control the tracks of the external device.

Note: This speaker do not need the password.

7.Connect with AUX Line in

Instructions:

- 1.Press "FUNCTION" button on the top control panel or press AUX key on the remote control to switch to the AUX mode,
- 2.(AUH) will be displayed on the display screen and the AUX indicator light will light on if switch successfully.
- 3.Connect this speaker to AUX inserting jack and the external device Earphone jack by provided AUX cable;
- 4.Once connected,turn on your external device music
- 5.You can use ◀◀ or ▶▶ button on the Top control panel to control the tracks of the external device.

Caution: Please turn off the unit before connect AUX cable in order to avoiding unexpected noise.

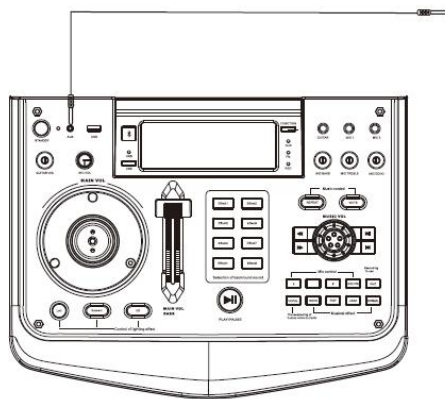

8.Connect with Wired Microphone



Insert 6.35mm wired microphone to use the microphone function.



When playing with the wired microphone, please use these knob to adjust the bass / treble / echo volume of microphone.

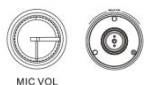

When playing with the wired microphone, please turn these two rotary knob to adjust the volume of microphone.



When playing with the wired microphone, please press this PRIORITY button to open the microphone priority.

Important Notes

- 1.While using the microphone, avoid being put the microphone opposite the bass of Speaker, as they may have Whistler Noisy.
- 2.To get the best singing performance, keep the micro phone within 5-15cm of the mouth and at a 45 degree angle.
- 3.When using the microphone, always pay attention to the battery.
- 4.If the battery is low, the indicator light will come on and the performance will progressively become poor.

Caution: Please do not put the microphone directly face to the speaker, it may damage the speaker.

9.Product information

Specifications

Amplifier	
-----------	--

Output power	120W
Input Sensitivity	L&R: 830mV~2V (±20%) SW: 450mV~2V (±20%)
FM	
FM range	87.5-108MHZ
Step	0.1MHZ
Speaker	
Treble Speaker	3 Inch
Bass Speaker	8 Inch
General information	
AC Power	110-240V~,50Hz/60Hz
Dimension	400*315*450MM
Weight	

USB play ability information

Compatible USB storage devices:

- USB flash memory (USB 2.0 or USB 1.1)
- USB flash players(USB 2.0 or USB 1.1)
- Memory cards (requires an additional card reader to work with this apparatus)

Supported for formats:

- USB or memory file format FAT12,FAT16,FAT32(sector size:512 bytes)
- MP3 bitrate (data rate):32-320Kbps and variable bitrate
- Directory nesting up to a maximum of 8 levels
- Number of albums/folders:maximum 99
- Number of tracks/titles:maximum 999
- File name in Unicode UTF8 (maximum length:32 bytes)

Unsupported formats:

- Empty albums: an empty album is an album that does not contain MP3.
- Unsupported the file formats are skipped. For example, Word documents (.doc) or MP3 files with extension .dlf are ignored and not. played.

10.Troubleshooting

Warning

- Never remove the top panel and rear panel of this speaker.

If you encounter problems when using this speaker,check the following points before requesting service.

No power

- Ensure that the AC power plug of the speaker is connected properly.
- Ensure that there is power at the AC outlet.

No sound or poor sound

- Adjust the volume.
- Disconnect the headphones.
- Check that the speakers are connected correctly.

No response from the speaker

- Disconnect and reconnect the AC power plug, then turn on the speaker again.

Remote control does not work

- Before you press any function button, first select the correct source with the remote control instead of the speaker.
- Reduce the distance between the remote control and the unit.
- Insert the battery with its polarities(+/- signs) aligned as indicated.
- Replace the battery.
- Aim the remote control directly at the sensor on the front of the speaker.

Cannot play from USB device

- The formats of these files are not supported.
- The USB device is incompatible with the unit. Try another one.

Poor radio reception

- Increase the distance between the speaker and your TV.
- Fully extend the FM antenna.
- Put the speaker in an open area to search for radio.

FCC Warning

This device complies with part 15 of the FCC rules. Operation is subject to the following two conditions: (1) this device may not cause harmful interference, and (2) this device must accept any interference received, including interference that may cause undesired operation.

Changes or modifications not expressly approved by the party responsible for compliance could void the user's authority to operate the equipment.

NOTE: This equipment has been tested and found to comply with the limits for a Class B digital device, pursuant to part 15 of the FCC Rules. These limits are designed to provide reasonable protection against harmful interference in a residential installation. This equipment generates noise and can radiate radio frequency energy and, if not installed and used in accordance with the instructions, may cause harmful interference to radio communications. However, there is no guarantee that interference will not occur in a particular installation. If this equipment does cause harmful interference to radio or television reception, which can be determined by turning the equipment off and on, the user is encouraged to try to correct the interference by one or more of the following measures:

- Reorient or relocate the receiving antenna.
- Increase the separation between the equipment and receiver.
- Connect the equipment into an outlet on a circuit different from that to which the receiver is connected.
- Consult the dealer or an experienced radio/TV technician for help.

Radiation Exposure Statement

This equipment complies with FCC radiation exposure limits set forth for an uncontrolled environment. This equipment should be installed and operated with minimum distance 20cm between the radiator and your body.