

TECHNICAL GUIDE

LIFTING TOWER

HERCULES 8



HERCULES Series

FENIX



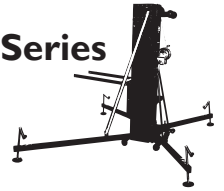

INDEX

I. INTRODUCTION

2. GENERAL DATA

2.1. Technical data

2.2. Applicable regulations

3. GENERAL SAFETY RULES

4. HOW TO USE

5. MAINTENANCE

6. SPECIFIC RISKS

7. PREVENTION SYSTEMS

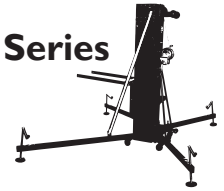

I. INTRODUCTION

This instruction manual has been drafted pursuant Machinery Directive CE 2006/42/EG requisites. The instruction manual is an integral part of the lifting tower to be consulted before, during and after tower start-up, likewise whenever deemed necessary, respecting the contents for each and all the parts thereof. This is the only way to achieve the basic objectives established in the manual base such as preventing accident risks and maximum optimisation possible for the lifting tower features. This manual has taken extreme care regarding safety and accident prevention at work while using the machine highlighting information of particular interest to the user.

**ATTENTION: PRIOR TO USING THE LIFTING TOWER,
READ THIS MANUAL CAREFULLY**

2. GENERAL DATA

2.1. Technical Data

NAME	LIFTING TOWER
MODEL	HERCULES 8
TECHNICAL CHARACTERISTICS	<p>Maximum height: 8m. Folded height: 1,99m. Maximum load: 300kg. Minimum load: 25kg. Material: Aluminium AL Si 6082 / T6. Open base area: 2,46m x 2,29m. Closed base area: 0,51m x 0,65m. Weight: 208kg. Winch: 1.100kg. Maximum load with automatic load retention brake. Cable: Galvanized steel under EN12385-4. Right hand ordinary lay. MaxLoad: 19600N Tensile strength: 1770N/mm². Diameter: 6mm. Length. 19+1m Fixation of tower sections to working height with safety pins. Leg anchorage with safety pins. Bubble level to adjust tower vertical position.</p>
EQUIPMENT DESCRIPTION	<p>Lifting tower HERCULES 8 designed to vertically raise structures and lighting and sound equipment to different heights. Tested by skilled personnel having passed all the operating, maximum load and dimension inspections.</p>
COMPANY	ROLLSPEED, S.L. (FENIX)
ADDRESS	Camino Alquerieta, 10 / 46470 - Massanassa, Valencia (Spain)

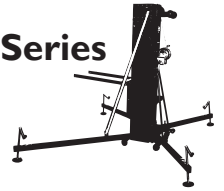

PHOTO

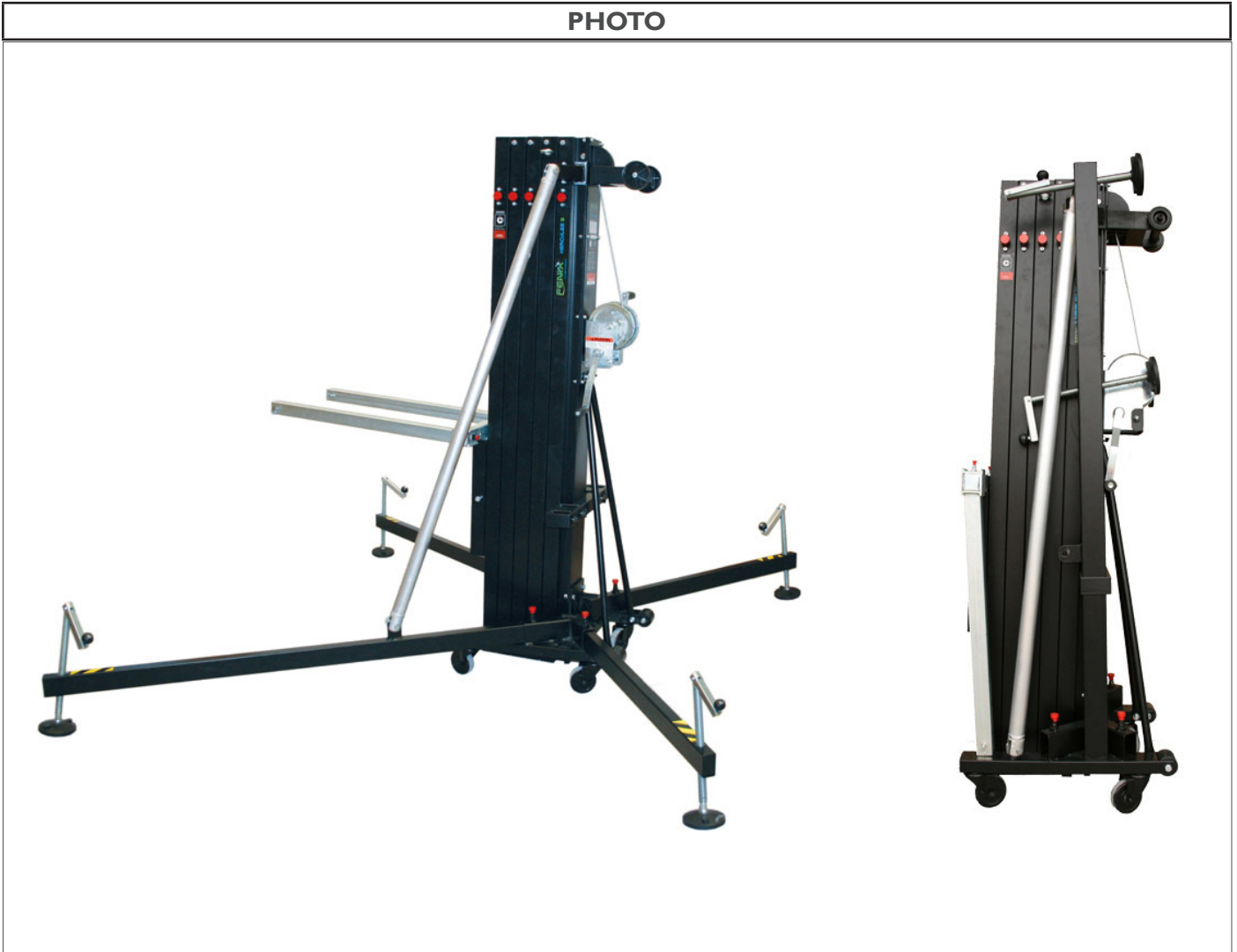

2.2. Applicable regulations

- Directives CE 2006/42/EG on machinery.
- BGV CI (GUV 6.175).
- BGG 912 (GUV 66.15, GUV G-912).
- EN 12385-4:2008-06 .
- DIN EN 10305-3:2010-05 .

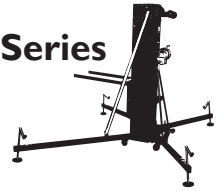

3. GENERAL SAFETY RULES



The lifting tower is an industrial element designed to raise loads vertically, it must NEVER be used as a platform elevator for people.



Only place the lifting tower on firm flat grounds checking it is in vertical position. Do not use wedges or any strange elements to balance the hoist.

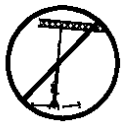

Check legs are correctly assembled and secured by their safety pins.

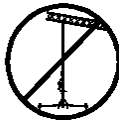

Never raise a load without first checking it is correctly supported and centred on the appropriate lifting tower supports, so the load only acts vertically.



Never surpass the maximum load capacity indicated on the lifting tower label of characteristics and this instruction manual.



If there is a likelihood of strong wind or gusts, place the lifting tower on the ground and secure it with the aid of straps.

Never fix a strap over a vehicle or any other element which might move.

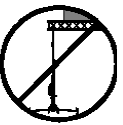

Never use a ladder over the lifting tower or leaning against it for any kind of work.



Beware of any kind of projection above the lifting tower like cornices, balconies, luminous signs, etc. It is very important to avoid the presence of cables below the lifting tower working height.



Never move the lifting tower when the load is raised. It is inadvisable to make any kind of movement, even small positioning adjustments.



Never use the lifting tower over any mobile surface or vehicle.

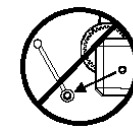

Before using the lifting tower, check the cable state, which must not present any broken threads or compression. NEVER EVER use defective cables and change cable if in doubt. Only use steel cable as described in this manual.



Fix the lever when the load is raised.

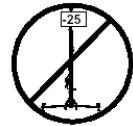

Minimum load for braking function without problems is 25kg. Brake will not function without this minimum load.



Neither grease nor lubricate the winch brake mechanism. Braking disks were greased with a special heat and pressure resistant grease.

No other products must be used to prevent negative influence on brake functioning.



All sections must be lowered to transport the lifting tower.

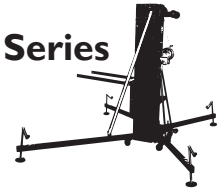

4. HOW TO USE

Fig.1

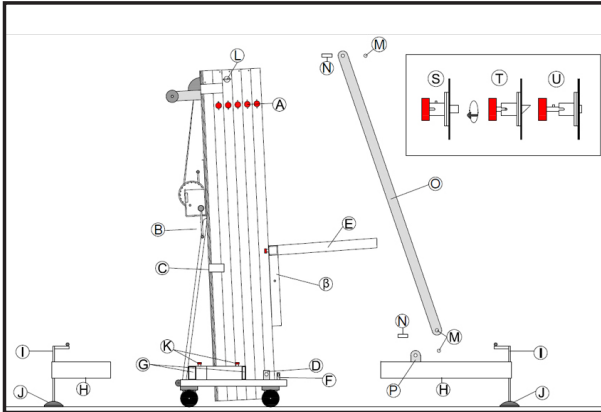

1. Place the lifting tower over a firm and flat surface in its working place.
2. Remove the outriggers (**H**) from their transport supports (**C**) and insert them into their working positions (**G**) checking that they are fixed by the safety pins (**K**). The longest outriggers must be placed on the front, under the load.
3. Remove the front support bars (**O**) from its transport support (**D**) and place them in its anchoring support (**P**) on each front outrigger, ensuring that they are fixed with the safety pins (**M & N**). In order to fix properly the front support bars (**O**), adjust the support of the front outrigger by turning the stabiliser crank. Insert safety pins (**M & N**).

Fig.2

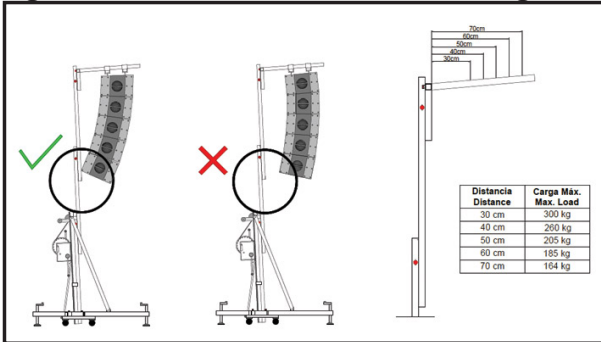

Fig.3

4. Adjust the outrigger stabilisers (**J**) by turning the cranks (**I**) to level the lifting tower. Ensure it is in a vertical position checking the bubble level.
5. Place the forklifts (**E**) in a horizontal position and secure them with the safety pins.
6. Place the load as close to the lifting tower as possible.

Fig.4

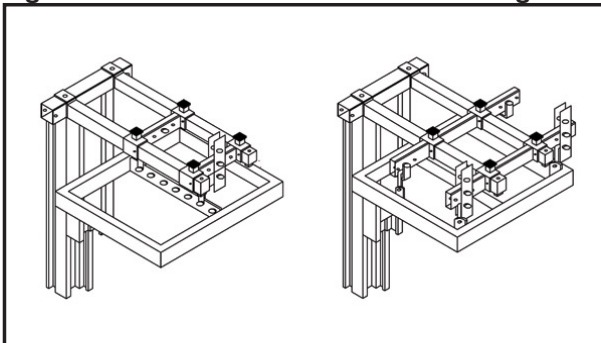

Fig.5

7. Place on the forklifts (**E**) the supports AC-584 and AC-585 in case of flying a line array system with central anchoring by either one or two hanging points. **See fig. 4**. If the line array's bumper has four hanging points, use the supports AC-582 and AC-583 which enables to fly the line array system from four hanging points. **See fig. 5**.

8. Elevation: Turn the winch handle (**B**) clockwise to lift the load until the wished position, checking that safety pins (**A**) are activated (**T**).
9. When erecting the lifting tower outdoors, the risk of wind is prevalent. When wind speed exceeds 30km/h, it is mandatory to bring down the lifting tower, for which we have provided two fixing side rings (**L**) in the upper part of the second profile, where tensors should be attached and fixed on a secure and firm surface. (Never on a vehicle or anything that can move).

10. To avoid lifting tower overloading, do not separate unnecessarily the line array from the body of the lift. **See fig 2**. Follow loading instructions. **See fig 3**.

11. Lowering: release the safety pins (**A**) doing the action **U**. To release them, turn slightly the winch handle to elevate the load. In the normal working position, the load's weight does not allow to release the safety pins. Once the safety pin (**A**) is unblocked, turn the winch handle (**B**) opposite clockwise until lowering the load and the first profile is completely down. Release the safety pins (**A**) and keep on lowering the lifting tower until the second profile is completely down. Unblock the safety pin (**A**) and continue lowering the lifting tower until it is completely folded as its minimum height.

12. For the lifting towers' transport is necessary to bring down all the profiles unless the carriage (**β**), releasing the safety pin (**A**) doing the action **U**. Block all profiles with the safety pins (**A**) in the position (**S**). Put the forklifts (**E**) in its initial position. Move the front support bars (**O**) from its anchoring support (**P**) and fix them to its transport support (**D**) fixing it with the safety pins (**M & N**).

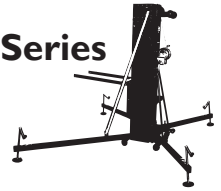

5. MAINTENANCE

1. Periodically check cable status. If the cable seems to have broken cable wires or crushing, replace immediately with a new one. Never use the lifting tower with cables in bad conditions. Only use galvanized steel under EN 12385-4. Right Hand Ordinary Lay. MaxLoad: 19600N Tensile strength: 1770N/mm². Diameter: 6mm. Length: 19+1m
2. The lifting tower is supplied fully greased from factory. Nevertheless, periodical greasing is recommended as per use to the crown gear of the winch, to the threaded bar of the stabiliser outriggers and the profiles to .

WARNING: DO NOT GREASE OR LUBRICATE BRAKING MECHANISM

Braking disks were greased with a special heat and pressure resistant grease. No other product must used to prevent negative influence on brake functioning.

3. Lifting tower HERCULES 8, must be checked by an expert once a year minimum as per its use.
4. Only original spare parts must be used to ensure continued safe use. The user loses all guarantee rights if spare parts other than the originals are incorporated or modifies the product in any way.
5. To request any spare part, contact the manufacturer or an authorised distributor within your territory.

6. SPECIFIC RISKS

BRAKING SYSTEM FAILURE

May occur due to braking system deficiencies or bad installation. If it stops working it could cause a serious risk due to the raised load will be out of control and injure users or hit materials next to the tower.

LOSS OF STABILITY

If the tower is placed on a sloping ground or a surface that is not completely flat there is a risk of loss stability which would lead to a 90° overturn with risk of serious injuries for workers.

OBJECTS DROPPING TO A DIFFERENT LEVEL

As an elevation equipment and due to it is working high, there is a serious risk of raised objects dropping to a different level, either due to securing mechanism failure, part wear, dirt, etc., or incorrect use of the lifting tower (E.g.: for goods over the maximum load allowed). Sudden drop of raised goods implies a serious risk for the worker.

KNOCKS AND/OR CONTUSIONS DUE TO OBJECTS

This risk only occasionally causes an accident to the worker running the operation due to his location during the elevation process; the risk of knocks from a raised element is more likely to affect people walking by or whose workplace is next to the lifting tower. Its origin may be due to loss of stability, malfunctioning of structural elements, safety systems, securing systems, etc.

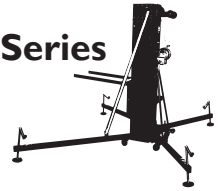

7. PREVENTION SYSTEMS

BRAKING SYSTEM FAILURE

Equip with winch complying with regulations mentioned in the BGV CI directive, specially DIN 56925 and DIN EN 292.

LOSS OF STABILITY

Maintenance of lifting tower stability must basically be as per the following measures:

- Professionalization, training and risk awareness of lifting tower users.
- Equip with different safety devices and advices from the manufacturer to reinforce stability, like:
 - Safety pins which secure the lifting tower once raised.
 - Bubble level to help vertical adjustment.
 - Fixing maximum load that the lifting tower can raise.
 - Maximum slope specification which the lifting tower can access safely.

OBJECTS FALLING TO A DIFFERENT LEVEL, KNOCKS AND/OR CONTUSIONS FROM OBJECTS

The risk of objects falling to a different level can be prevented using homologated safety elements, e.g., a safety pin which fixes the interior profile of the lifting tower in its working position, so the cable does not support load and guaranteeing impossibility of a drop. In the event of cable breakage, the braking system will act automatically. Furthermore, if steel elements have been zinc coated this protects the entire unit from oxidation and corrosion.

These risks can also be minimised with correct lifting tower maintenance. The user must perform periodical inspections on safety elements and make the necessary repairs in case of detecting deficiencies

Moreover, the consequences of these risks can be reduced limiting an access area to the lifting tower and with a correct training of personnel.

NOISE EMISSIONS

This equipment doesn't produce more than 80 decibels.