

# EXL-IP65 Strobo 120° CW 504W

**EXALITE**

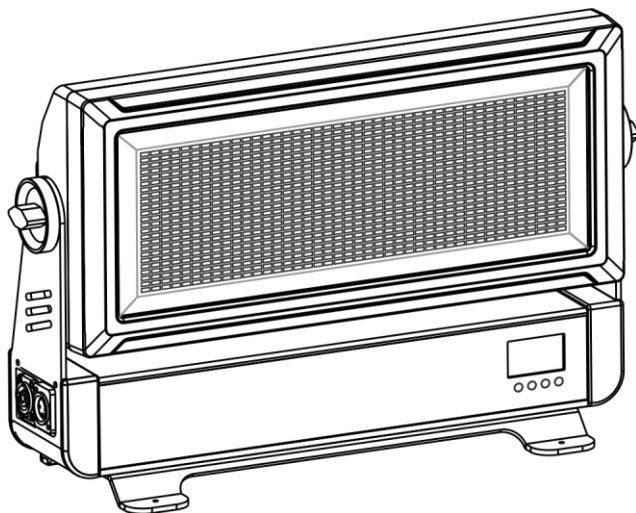

This product manual contains important information about the safe installation and use of this projector. Please read and follow these instructions carefully and keep this manual in a safe place for future reference.

## User manual

Please read the instructions carefully before use

# TABLE OF CONTENTS

- 1. Dimension ..... 3
- 2. Safety Information ..... 3
- 3. Parts identification and terminology ..... 5
- 4. Preparing for installation ..... 6
- 5. Installation ..... 6
- 6. Connecting AC Power ..... 7
- 7. Configuring the fixture..... 8
- 8. Connecting to a DMX control device ..... 8
- 9. Configuring the fixture for DMX control ..... 10
- 10. Cleaning ..... 11
- 11. DMX protocols..... 12
- 12. Control menu ..... 13
- 13. Specification ..... 15
- 14. Photometrics..... 16

## STATEMENT

The product has well capability and intact packing when leave factory. All of the user should comply with warning item and manual, any misuse cause of the damages are not included in our guarantee, and also can not be responsible for any malfunction & problem owing to ignore the manual.

# 1. Dimension

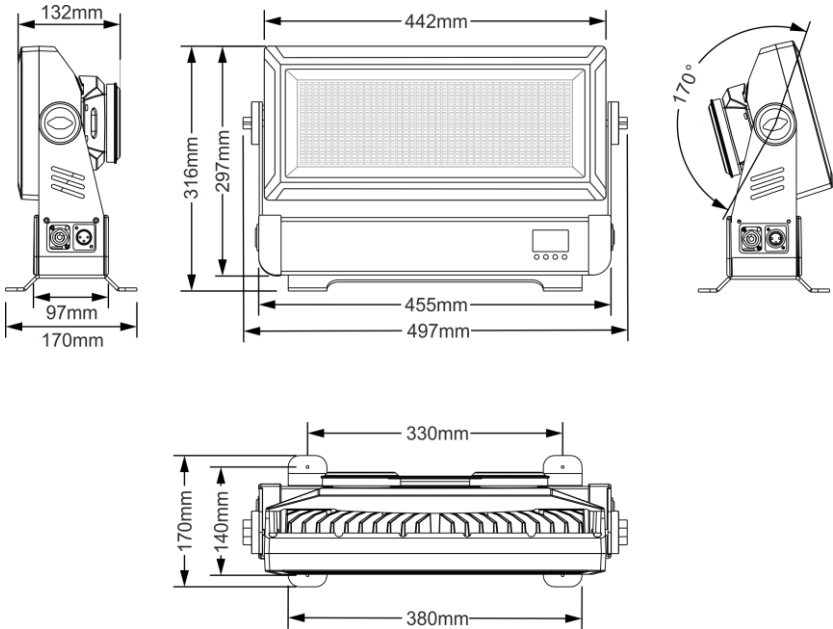

# 2. Safety Information



**WARNING!** Read the safety precautions in this section before unpacking, installing, powering or operating this product.

This luminaries are multi-environmental fixtures with an IP-rating of 55, intended for professional use only. They are not suitable for household use.

Review the following safety precautions carefully before installing or operating the fixture. This fixture must be installed in accordance with the applicable installation code by a person familiar with the construction and operation of the fixture and the hazards involved.

## Preventing electric shock



**WARNING!** Risk of electric shock.

- Always power off/unplug the fixture before removing any covers.
- Ensure that the power is turned off when connecting the fixture to the AC mains supply.
- Ensure that the fixture is electrically connected to earth (ground).
- Do not apply power if the fixture is in any way damaged.
- Do not immerse the fixture in water or liquid.

## Preventing burns and fire



**WARNING!** Take measures to prevent burns and fire.

- Install in a location that prevents accidental contact with the fixture.
- Install only in a well-ventilated space.
- Install at least 0.3 m (12 in.) away from objects to be illuminated.
- Install only in accordance with applicable building codes.
- Ensure a minimum clearance of 0.1 m (4 in.) around the cooling fans.
- Do not paint, cover or modify the fixture.
- Keep all flammable materials away from the fixture.
- Allow the fixture to cool for 15 minutes after operation, before touching it.
- CAUTION: Exterior surface temperature after 5 min. operation = 45 °C (113 °F). Steady state = 60 °C (140 °F).

## Avoid personal injury



**WARNING!** Take measure to prevent personal injury.

- Do not look directly at the light source from close range.
- Take precautions to prevent injury due to falls when working at height.
- For permanent installation, ensure that the fixture is securely fastened to a load-bearing surface with suitable corrosion-resistant hardware.
- For temporary installation with clamps, ensure that the quarter-turn fasteners are turned fully and secured with a suitable safety cable. The cable must be approved for a safe working load (SWL) of 10 times the weight of the fixture, and it must have a minimum gauge of 3 mm.

### 3. Parts identification and terminology

- A Seetronic IP65 sockets
- B 1008 LEDs
- C LCD display
- D Control panel
- E Seetronic IP65 sockets
- F Connection cable
- G Base bracket
- H Base
- I Safety wire eyelet
- J Colling fans
- K Tilt lock
- L Tilt lock

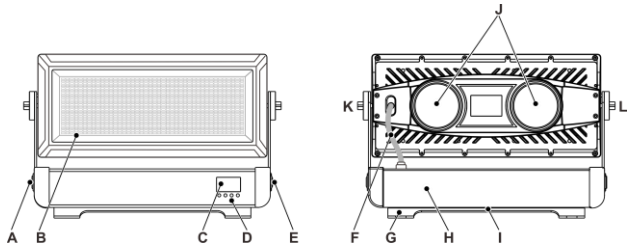

## 4. Preparing for installation

Unpack the fixture and inspect it to ensure that it has not been damaged during transport.

The fixture is shipped with two quarter-turn brackets, that can be used to mount the fixture at elevation.

The fixture is IP65-rated, and is designed for use in wet locations. This means that it is protected from:

- Dust, to the degree that dust cannot enter the fixture in sufficient quantities as to interfere with its operation.
- Lower pressure jets of water from any direction.

When selecting a location for the fixture, ensure that:

- It is situated away from public thoroughfares and protected from contact with people.
- It is not immersed in water or exposed to high-pressure water jets.
- It has adequate ventilation.

## 5. Installation

The fixture may be installed in any orientation, but if installed horizontally with a downward beam-angle, water can potentially pool in the fan wells. Under normal operation the moisture will evaporate. However, in locations with high rainfall, you may wish to fabricate a rain shield above the fixture, or modify the position and orientation of the fixture to minimize pooling.

For permanent installation on the ground, remove the rubber feet from the floor stand/ base. Fasten securely through the resulting holes with four corrosion-

resistant mechanical fasteners suitable for the location.

Two quarter-turn brackets are supplied with the fixture if it is to be flown above the ground. Remove the floor stand/base and rig the fixture to a support truss or structure using the supplied brackets and suitable clamps.

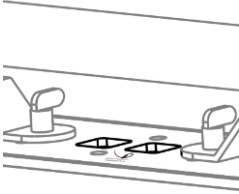

Fasten a safety cable (not shown) between the support structure and the attachment point on the fixture. The safety cable must be able to bear at least 10 times the weight of the fixture.

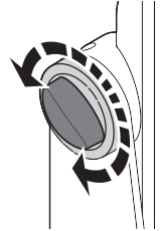

**WARNING!** Always secure an elevated fixture with a safety cable as backup.

The fixture can be tilted from 0° - 190°. To adjust the tilt angle, loosen the two tilt screws, one of each side of the fixture, tilt the fixture to the angle required and re-tighten the screws.

**CAUTION:** If the fixture has been operating, always allow it to cool for 15 minutes before handling.

## 6. Connecting AC Power

The fixture can operate on any 100–240 V, 50/60 Hz AC mains power supply. It draws approximately 2 amps at full power. For permanent installation, have a qualified electrician wire the mains cable directly to a suitable branch circuit.

The junction's ingress protection (IP) rating must be suitable for the location.

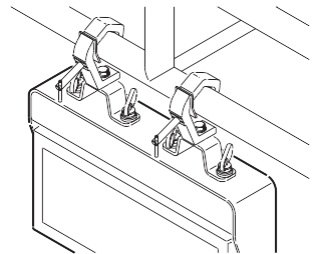

For temporary installation, the mains cable may be fitted with a grounded connector intended for exterior use.

When installing standard type C circuit breakers there will be no limitations due to the fixture in-rush current. Due to the nominal current of the fixture, ensure that no more than:

4 fixtures are connected through the same type C, 10A circuit breaker.

7 fixtures are connected through the same type C, 16A circuit breaker.

The fixture must be grounded/earthed and be able to be isolated from AC power. The AC power supply must incorporate a fuse or circuit breaker for fault protection.

After connecting the fixture to power, run the on-board test, using the “Mode →Auto” menu, to ensure that the fixture and each LED are functioning correctly. See “Control menu” on page 13.

**CAUTION:** Do not open the fixture to replace the supplied power cable, or connect the fixture to an electrical dimmer system, as this can damage it.

## 7. Configuring the fixture

Set up the fixture using the control panel and LCD display at the base of the fixture.

Navigate the menus and options using the arrow buttons and select items using the Enter button. The options available are listed in “Control menu” on page 13. After powering on, the display shows the currently selected operating mode and other information.

The fixture is set by default to be controlled in DMX mode.



### ***Master/Slave configuration***

You can set a fixture to operate as master fixture to another fixture (which then becomes a slave fixture), or an entire group of fixtures (which then becomes slave fixtures). The assigned slave fixture(s) will mimic the settings of the master fixture. Use the “Mode→Auto1/ Auto2/ Auto3/ Auto4” menu to set your fixture as master fixture, then other fixture set to DMX mode as slave fixture.

### ***Using stand-alone operation***

Stand-alone operation is where the fixture is not connected to a control device, but is preprogrammed with 4 modes (Auto1/Auto2/Auto3/Auto4), that play continuously in a loop, the run speed of “Auto1”, “Auto2” and “Auto3” are adjustable.

To define a stand-alone program, use the “Mode” menus (see “Control menu” on page 13).

## **8. Connecting to a DMX control device**

The fixture is controllable using a DMX control device and it can be connected using a DMX cable.

If using a cabled DMX system, connect the DMX in cable (with male 3-pin XLR plug) and out cable (with female 3-pin XLR plug) to the DMX data link. Terminate the DMX out cable of the last fixture in the data link. For outdoor installations, use only IP-rated XLR connectors suitable for outdoor use.

The DMX512 is widely used in intelligent lighting control, with a DMX 512 controller. connect several lights together, dmx in and dmx out, 3 pin XLR connectors: Pin 1: GND, Pin 2: Negative signal (-), Pin 3: Positive signal (+)

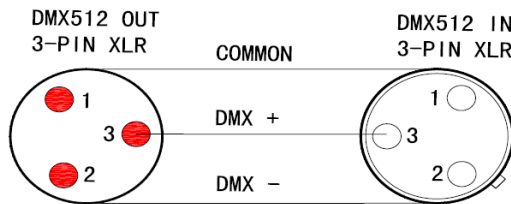
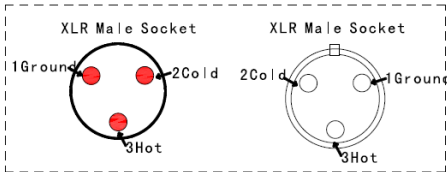

Figure2



XLR Pin Configuration	
pin1	=Ground
pin2	=Data Compliment (negative)
pin3	=Data true (positive)

## 9. Configuring the fixture for DMX control

### About DMX

The fixture can be controlled using signals sent by a DMX controller on a number of channels (which varies depending on the DMX mode that has been set).

The first channel used to receive data from a DMX control device is known as the DMX start address. Each fixture must have a DMX start address set. For example, if a fixture has a DMX address of 10 and it is in 4-channel DMX mode, then it uses channels 10, 11, 12 and 13. The following fixture in the DMX chain could then be set to a DMX address of 14. If two or more DMX fixtures of the same type have the same DMX address, then they will mimic each other's behaviour. Incorrect settings will result in unpredictable responses to the lighting controller.

## ***Setting the DMX address***

The DMX address can be seen on the main screen. To change the address setting, press the up arrow to increase the address, or the down arrow to decrease the setting. When the desired address is displayed, press Enter to save the setting.

Note that channel spacing is determined by the DMX mode. See the “DMX protocols” on page 12 for specific DMX control values.

## ***Setting the DMX mode***

Using the “DMX mode” menu available from the control panel, specify the DMX mode that provides the fixture controls that you require, confirm chosen mode by pressing ‘Enter’.

## **10. Cleaning**

To maintain optimal performance, regular cleaning is essential. Cleaning schedules will vary depending on the operating environment, and the installation should therefore be checked at frequent intervals within the first few weeks of operation to see whether cleaning is necessary. This procedure will allow you to assess cleaning requirements in your particular situation. Clean the fixture using a soft cloth dampened with a solution of water and a mild detergent. Do not use products that contain solvents, abrasives or caustic agents for cleaning, as they can cause damage to both hardware, cables and connectors.

# 11. DMX protocols

Configuring DMX is described "Setting the DMX mode" on page 11.

Channel			Value	Function
2CH	6CH	11CH		
*	1	1		<b><u>Section1 :</u></b>
			0-255	Section1 dimmer
*	2	2		<b><u>Section2 :</u></b>
			0-255	Section2 dimmer
*	3	3		<b><u>Section3 :</u></b>
			0-255	Section3 dimmer
*	4	4		<b><u>Section4 :</u></b>
			0-255	Section4 dimmer
*	5	5		<b><u>Section5 :</u></b>
			0-255	Section5 dimmer
*	6	6		<b><u>Section6 :</u></b>
			0-255	Section6 dimmer
1	*	7		<b><u>Dimmer :</u></b>
			0-255	All dimmer
2	*	8	0-9	No function
			10-255	Strobe
*	*	9		<b><u>Auto :</u></b>
			0-9	No function
			10-50	Auto 1
			51-100	Auto 2
			101-150	Auto 3
		151-200	Auto loop	

			201-255	No function
*	*	10		<b><u>Auto Speed:</u></b>
			0-255	Speed from slow to fast
*	*	11		<b><u>Dimmer Curve:</u></b>
			0-9	Dimmer curve based on menu setting
			10-50	Dimmer curve 1
			51-101	Dimmer curve 2
			102-152	Dimmer curve 3
			153-203	Dimmer curve 4
			204-249	Dimmer curve 5
			250-255	Dimmer curve 6

## 12. Control menu

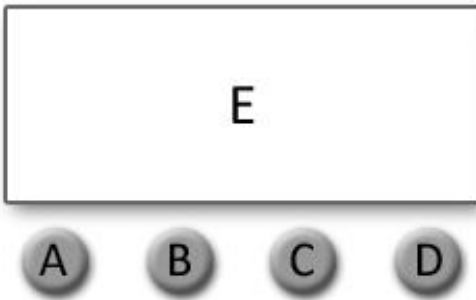

- A. MENU
- B. UP
- C. DOWN
- D. CONFIRM
- E. DIGITAL DISPLAY WINDOW

### Display:

- MENU** To select the programming functions
- DOWN** To go backward in the selected functions
- UP** To go forward in the selected functions
- ENTER** To confirm the selected functions (**unlock screen**)

## Set DMX Address:

1. Press "**ENTER**" to unlock screen, then press "**Menu**" to select "**Address**" and press "**ENTER**".
2. Showing "**DMX[001]**", Press the "**UP** or **DOWN**"keys to increase or decrease the DMX address value.
- 3 Press "**ENTER**" to save and Exit, Press "**MENU**" does not save and Exit.

Level 1	Level 2	Description
<b>Address</b>	001-512	<i>DMX address setting</i>
<b>Mode</b>	DMX_CH2	<i>2 channels mode</i>
	DMX_CH6	<i>6 channels mode</i>
	DMX_CH11	<i>11 channels mode</i>
	Auto 1 [001-099]	<i>Color change mode, speed adjustable</i>
	Auto 2 [001-099]	<i>Color fade mode, speed adjustable</i>
	Auto 3 [001-099]	<i>Color pulse mode, speed adjustable</i>
	Auto 4	<i>Color macro mixed</i>
<b>Adjust</b>	SECTION1	<i>Section1 manual dimmer</i>
	SECTION2	<i>Section2 manual dimmer</i>
	SECTION3	<i>Section3 manual dimmer</i>
	SECTION4	<i>Section4 manual dimmer</i>
	SECTION5	<i>Section5 manual dimmer</i>
	SECTION6	<i>Section6 manual dimmer</i>
	CURVE	<i>Dimmer curve reference to CH11</i>
TEMP	<i>Fixture temperature display</i>	

## 13. Specification

### **Light Source:**

AC90-240V, 50/60HZ

450W power consumption

1008 x 0.5W White LEDs (Warm white, Cool white optional)

50,000 hours expected lifetime

120° fixed beam angle

### **Control:**

6 sections led, each section can be control individually

DMX512, Master-Slave, Auto

2/6/11 DMX channels

0-100% 32bit linear dimming

1-20 times/second strobe

4 built in auto mode

6 Dimmer curve

### **Construction:**

170° Tilt adjustment

Cast aluminum body

IP65 rating

2 x two quarter-turn locking points for one or two Omega brackets

Floor stand or hanging rigging possibilities

Bottom mount for safety wire

Forced air cooling system

IP65 Seetronic PowerCON in and out

IP65 Seetronic DMX in and out

# 14. Photometrics

