



FEATURES

- Install/Portable Hybrid
- Two-way, full range loudspeakers
- Large, user-rotatable horns for optimized pattern control
- Beamwidth-matching crossover point
- Long-lasting reliability

APPLICATIONS

Band PA, DJ System, Dance Club, Schools, Houses of Worship, Rental Systems, Mobile Churches, Auditoriums

DESCRIPTION

The VFR89 two-way, full range loudspeaker system includes a direct-radiating, vented, 8-in LF cone transducer and a 1-in exit / 1.25-in voice coil HF compression driver loaded with a large, square, user-rotatable 90x50 coverage pattern horn. The square horn allows installers to mount the enclosure in a horizontal configuration, but by rotating the horn 90 degrees, maintain the system's coverage pattern.

Because VF Series full range systems (VFR/VFM) use HF sections similar to those developed for the MK Series, EAW engineers could employ the same revolutionary "beamwidth-matching" internal passive crossover/filter networks that set the MK Series apart from all other two-way systems. If powered by an EAW-specified amplifier or via a UX Series digital signal processor, the VFR89 can enjoy the benefits of EAW Focusing, a technology that eliminates the anomalies inherent in the time domain of any loudspeaker.

The VFR89 includes traditional portable features such as handles, pole cup, and parallel NL4 connectors as well as permanent installation features such as barrier strip input, an optional transformer, and OmniMount mounting points. The unique design integrates the handles into the enclosure, leaving the sides smooth and attractive. Optional rigging hardware is available for preconfigured arrays with VFS sub bass systems.

Six year warranty.

2-WAY FULL-RANGE LOUDSPEAKER 90° × 50°

See NOTES TABULAR DATA for details

CONFIGURATION

Subsystem:		
	Transducer	Loading
LF	1 × 8 in cone	Vented
HF	1 × 1 in exit, 1.25 in voice coil compression driver	Horn-loaded

Operating Mode:		
	Amplifier Channels	External Signal Processing
	Single-amp LF/HF	High pass filter

PERFORMANCE

Operating Range:	70 Hz to 20 kHz	
Nominal Beamwidth: (rotatable)		
Horz	90°	
Vert	50°	
Axial Sensitivity (whole space SPL):		
LF/HF	92 dB	70 Hz to 20 kHz
Input Impedance (ohms):		
Nominal	Minimum	
LF/HF	8	6.7 @ 197 Hz
Input Taps (With TX-VFR Transformer installed):		
70V	100V	
LF/HF	128W / 64W / 32W / 16W	128W / 64W / 32W
High Pass Filter:	High Pass =>65 Hz, 12 dB/octave Butterworth	
Accelerated Life Test:		
LF/HF	51 V	325 W @ 8 ohm
Calculated Axial Output Limit (whole space SPL):		
Average	Peak	
LF/HF	118 dB	124 dB

ORDERING DATA

Description	Part Number
EAW VFR89 2-Way Full-Range Loudspeaker Black	2038062-90
EAW VFR89 2-Way Full-Range Loudspeaker White	2038848-90
Optional Accessories	
EAW Transformer Kit [ACC-TXVFR]	2039034
EAW Eyebolt/Forged Shoulder (M10)	0031810
EAW U-Bracket V8U Black [UBKT-V8U]	2039250
EAW U-Bracket V8U White [UBKT-V8U]	2039251

ENCLOSURE

Material Exterior-grade Baltic birch plywood
 Finish Wear resistant textured black paint
 Grille Powder-coated perforated steel

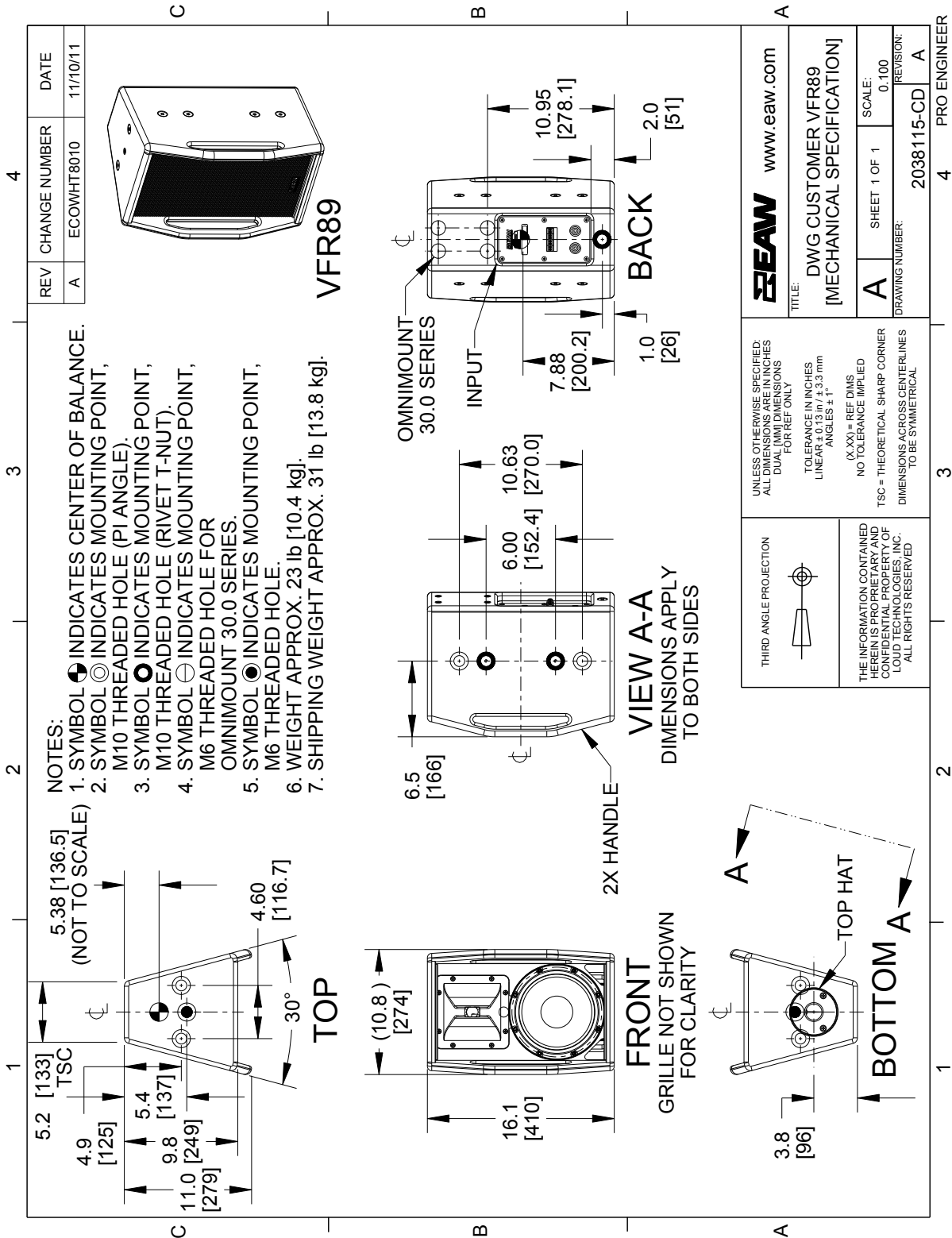

NOTE: This drawing has been reduced. Do not scale.

PERFORMANCE DATA

See *NOTES GRAPHIC DATA* for details

Frequency Response: Processed

Complete = blue

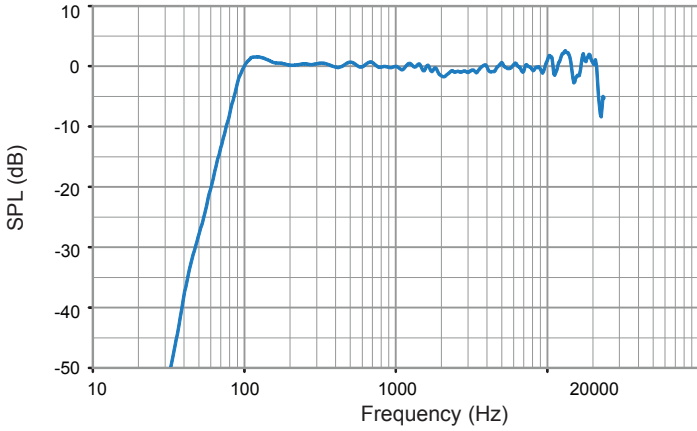

Frequency Response: Unprocessed

Complete = blue

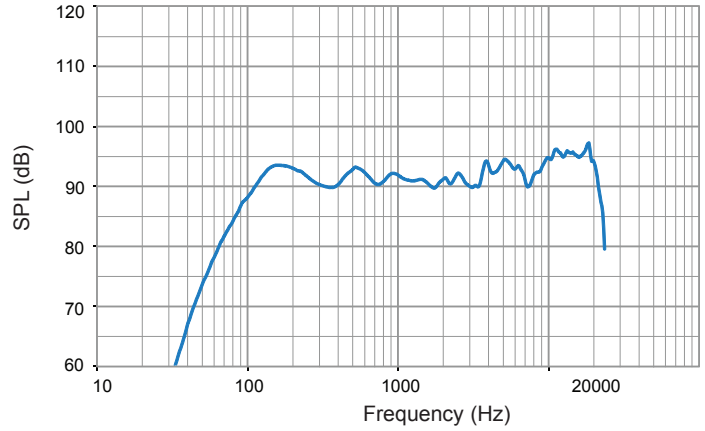

Impedance

Complete = blue

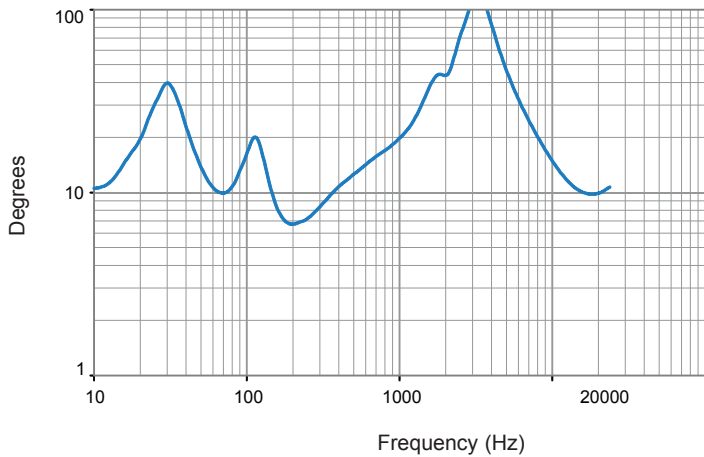

Phase Linearity

Complete = blue

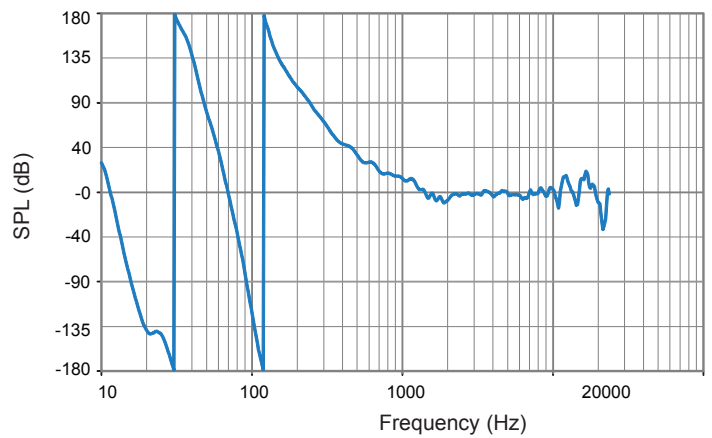

Beamwidth

Horizontal = orange Vertical = black

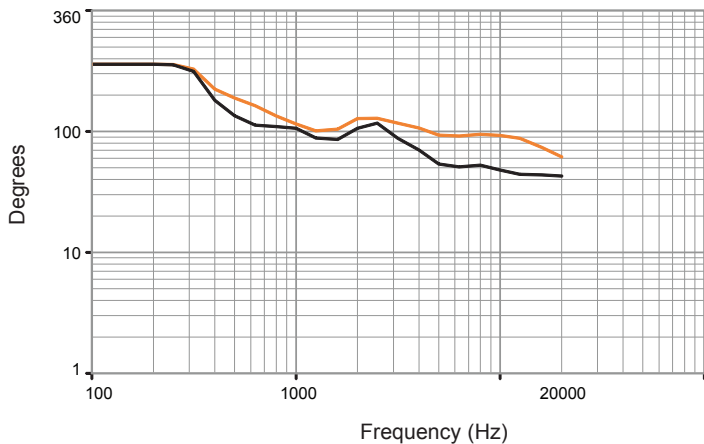

HORIZONTAL POLAR DATA

See *NOTES GRAPHIC DATA* for details

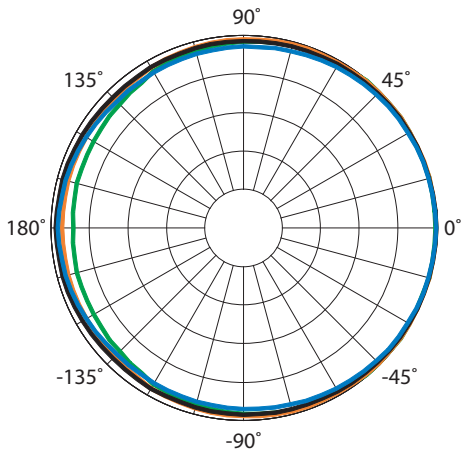

- 100Hz
- 125Hz
- 160Hz
- 200Hz

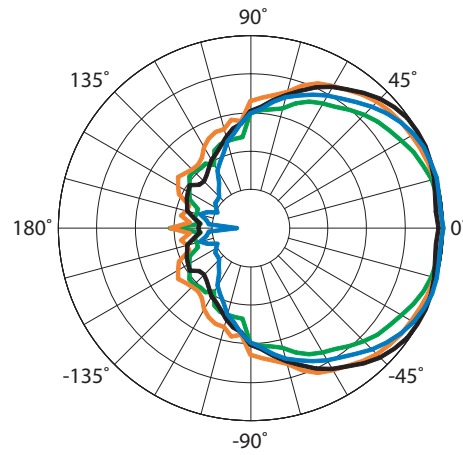

- 1600Hz
- 2000Hz
- 2500Hz
- 3150Hz

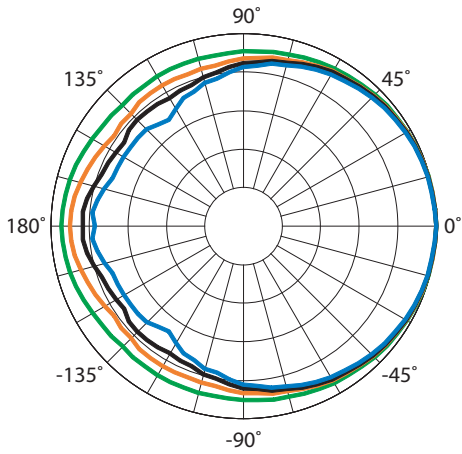

- 250Hz
- 315Hz
- 400Hz
- 500Hz

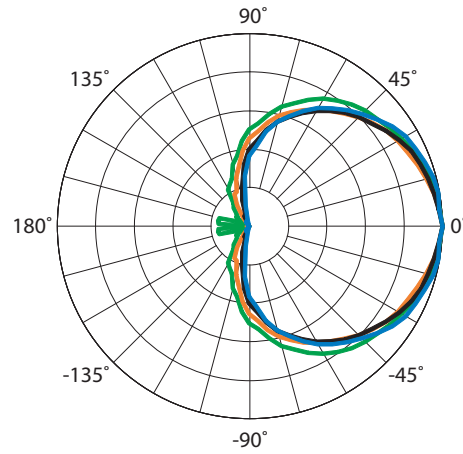

- 4000Hz
- 5000Hz
- 6300Hz
- 8000Hz

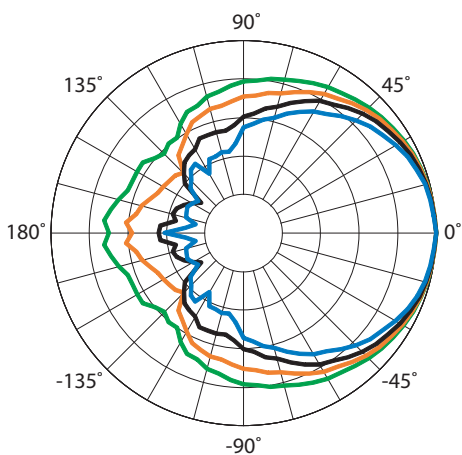

- 630Hz
- 800Hz
- 1000Hz
- 1250Hz

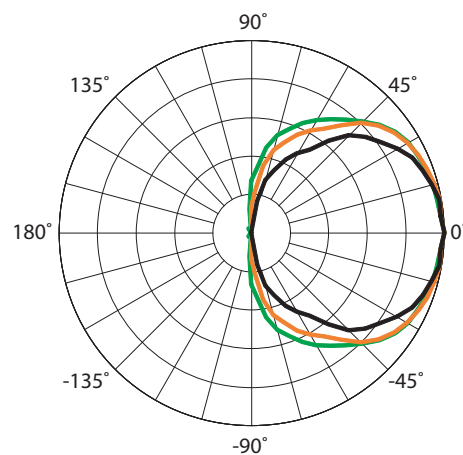

- 10000Hz
- 12500Hz
- 16000Hz

VERTICAL POLAR DATA

See *NOTES GRAPHIC DATA* for details

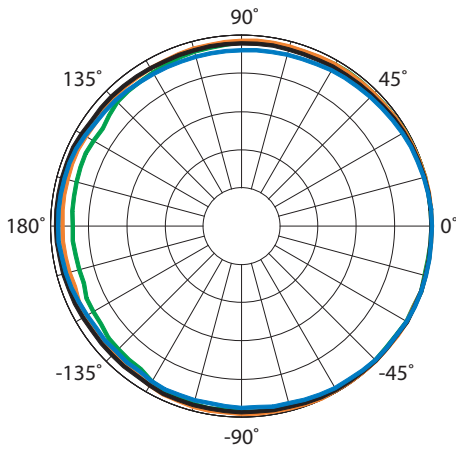

- 100Hz
- 125Hz
- 160Hz
- 200Hz

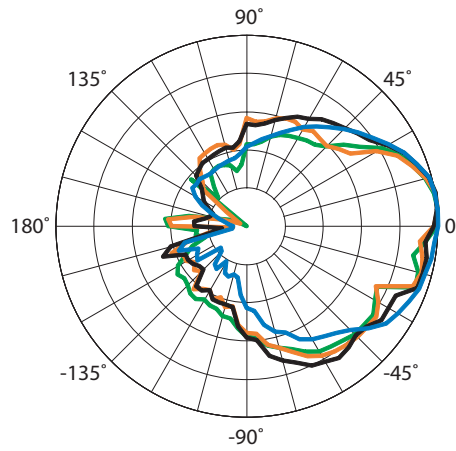

- 1600Hz
- 2000Hz
- 2500Hz
- 3150Hz

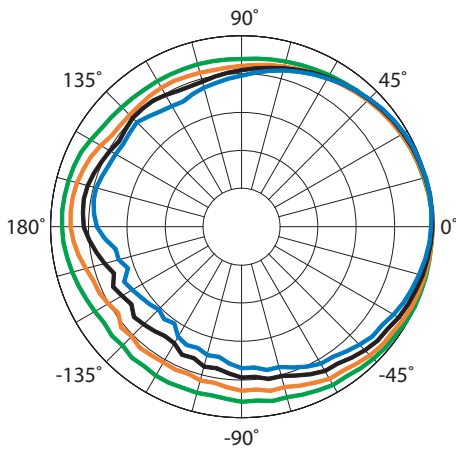

- 250Hz
- 315Hz
- 400Hz
- 500Hz

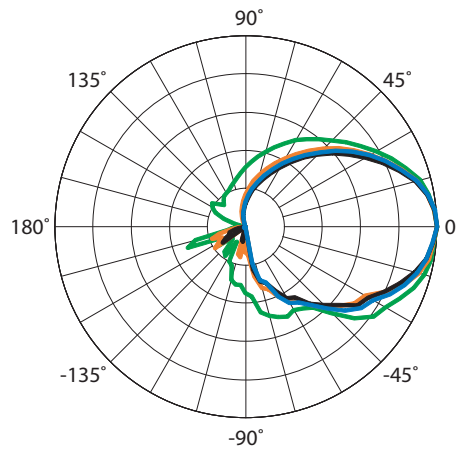

- 4000Hz
- 5000Hz
- 6300Hz
- 8000Hz

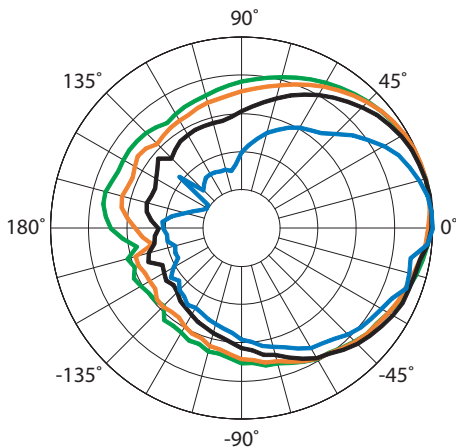

- 630Hz
- 800Hz
- 1000Hz
- 1250Hz

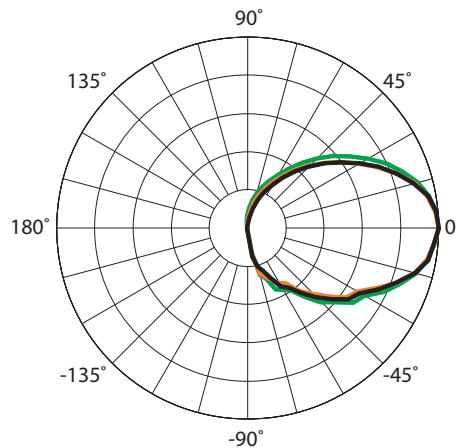

- 10000Hz
- 12500Hz
- 16000Hz

INPUT PANEL

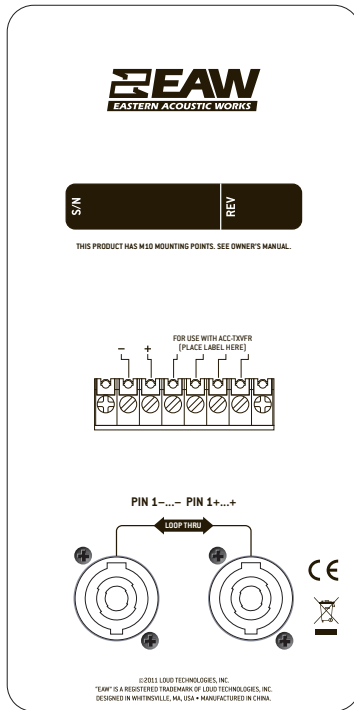

SIGNAL DIAGRAM

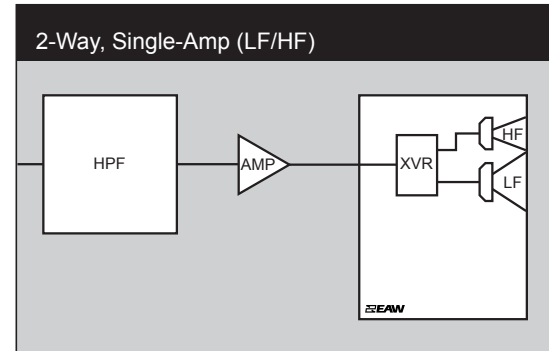

LEGEND

- DSP:** EAW UX8800 Digital Signal Processor –or– Integral Digital Signal Processing for NT products.
- HPF:** High Pass Filter for crossover –or– Recommended High Pass Filter.
- LPF:** Low Pass Filter for crossover.
- LF/MF/HF:** Low Frequency / Mid Frequency / High Frequency.
- AMP:** User Supplied Power Amplifier –or– Integral Amplifier for NT products.
- XVR:** Passive LPFs, HPFs, and EQ integral to the loudspeaker.
- EAW Focusing:** Digital Signal Processor capable of implementing EAW Focusing.

NOTES

TABULAR DATA

1. **Measurement/Data Processing Systems:** Primary - FChart: proprietary EAW software; Secondary - Brüel & Kjær 2012.
2. **Microphone Systems:** Earthworks M30; Brüel & Kjær 4133
3. **Measurements:** Dual channel FFT; length: 32 768 samples; sample rate: 48 kHz; logarithmic sine wave sweep.
4. **Measurement System Qualification** (includes all uncertainties): SPL: accuracy +/-0.2 dB @ 1 kHz, precision +/-0.5 dB 20 Hz to 20 kHz, resolution 0.05 dB; Frequency: accuracy +/-1 %, precision +/-0.1 Hz, resolution the larger of 1.5 Hz or 1/48 octave; Time: accuracy +/-10.4 µs, precision +/-0.5 µs, resolution 10.4 µs; Angular: accuracy +/-1°, precision +/-0.5°, resolution 0.5°.
5. **Environment:** Measurements time-windowed and processed to eliminate room effects, approximating an anechoic environment. Data processed as anechoic or fractional space, as noted.
6. **Measurement Distance:** 7.46 m. Acoustic responses represent complex summation of the subsystems at 20 m. SPL is referenced to other distances using the Inverse Square Law.
7. **Enclosure Orientation:** For beamwidth and polar specifications, as shown in Mechanical Specification drawing.
8. **Volts:** Measured rms value of the test signal.
9. **Watts:** Per audio industry practice, "loudspeaker watts" are calculated as voltage squared divided by rated nominal impedance. Thus, these are not True Watt units of energy as defined by International Standard.
10. **SPL:** (Sound Pressure Level) Equivalent to the average level of a signal referenced to 0 dB SPL = 20 microPascals.
11. **Subsystem:** This lists the transducer(s) and their acoustic loading for each passband. Sub = Subwoofer, LF = Low Frequency, MF = Mid Frequency, HF = High Frequency.
12. **Operating Mode:** User selectable configurations. Between system elements, a comma (,) = separate amplifier channels; a slash (/) = single amplifier channel. DSP = Digital Signal Processor. IMPORTANT: To achieve the specified performance, the listed external signal processing must be used with EAW-provided settings.
13. **Operating Range:** Range where the processed Frequency Response stays within -10 dB SPL of the power averaged SPL within this range; measured on the geometric axis. Narrow band dips are excepted.
14. **Nominal Beamwidth:** Design angle for the -6 dB SPL points, referenced to 0 dB SPL as the highest level.
15. **Axial Sensitivity:** Power averaged SPL over the Operating Range with an input voltage that would produce 1 W at the nominal impedance; measured with no external processing on the geometric axis, referenced to 1 m.
16. **Nominal Impedance:** Selected 4, 8, or 16 ohm resistance such that the minimum impedance point is no more than 20% below this resistance over the Operating Range.
17. **Accelerated Life Test:** Maximum test input voltage applied with an EIA-426B defined spectrum; measured with recommended signal processing and Recommended Protection Filter.
18. **Calculated Axial Output Limit:** Highest average and peak SPLs possible during the Accelerated Life Test. The Peak SPL represents the 2:1 (6 dB) crest factor of the Life Test signal.
19. **High Pass Filter:** This helps protect the loudspeaker from excessive input signal levels at frequencies below the Operating Range.

GRAPHIC DATA

1. **Resolution:** To remove insignificant fine details, 1/12 octave cepstral smoothing was applied to acoustic frequency responses and 1/3 octave cepstral smoothing was applied to the beamwidth and impedance data. Other graphs are plotted using raw data.
2. **Frequency Responses:** Variation in acoustic output level with frequency for a constant input signal. Processed: normalized to 0 dB SPL. Unprocessed inputs: 2 V (4 ohm nominal impedance), 2.83 V (8 ohm nominal impedance), or 4 V (16 ohm nominal impedance) referenced to a distance of 1 m.
3. **Processor Response:** The variation in output level with frequency for a constant input signal of 0.775 V = 0 dB reference.
4. **Beamwidth:** Average angle for each 1/3 octave frequency band where, starting from the rear of the loudspeaker, the output first reaches -6 dB SPL referenced to 0 dB SPL as the highest level. This method means the output may drop below -6 dB SPL within the beamwidth angle.
5. **Impedance:** Variation in impedance magnitude, in ohms, with frequency without regard to voltage/current phase. This means the impedance values may not be used to calculate True Watts (see 9 above).
6. **Polar Data:** Horizontal and vertical polar responses for each 1/3 octave frequency band 100 Hz to 16 kHz or Operating Range.