

QX564i Specifications



FEATURES

- High output, bi-amplified, three-way performance
- Broadband pattern control
- Ultra-efficient, coaxial MF/HF compression driver
- Four Phase Aligned™ 12-in cone transducers (vertical and horizontal pairs)
- Installation flexibility

APPLICATIONS

Houses of worship, arenas, outdoor stadiums, performing arts venues, theaters and clubs

DESCRIPTION

The new QX Series delivers high output, broadband pattern control and exceptional fidelity for a wide range of permanently installed applications. Its high output level make it appropriate for long throws in arenas and stadiums or for high-energy applications like live music venues or dance clubs. Its broadband pattern control lets it tame hostile acoustical environments like cathedrals or highly reverberant public spaces. And its exceptional fidelity pleases the most critical listeners in concert halls and performing arts centers.

The QX564i loads an ultra-efficient mid/high compression driver with a 60° (h) x 45° (v) constant directivity horn. Four Phase Aligned™ 12-in low frequency transducers arranged as vertical and horizontal pairs leverage beneficial interaction based on their spacing to extend pattern control well into the low frequency range.

Because the four low frequency transducers surround the coaxial mid/high compression driver symmetrically in both the horizontal and vertical planes, response across the full frequency spectrum appears to originate from a single point in space. This basic design facilitates an idealized summation of the three frequency sections, eliminating the anomalies associated with designs that physically offset the sections. This idealized coherence applies in both the horizontal and vertical planes throughout the coverage area.

Six year warranty.

3-WAY FULL-RANGE LOUDSPEAKER 60° x 45°

See *NOTES TABULAR DATA* for details

CONFIGURATION

Subsystem:

Transducer	Loading
LF 4x 12 in cone	Phase Aligned™
MF 1x 2 in exit, 3.5 in compression mid	Horn-loaded
HF 1x 2 in exit, 1.75 in compression driver	Horn-loaded

Operating Mode:

Amplifier Channels	External Signal Processing
Bi-amp (Passive MF/HF) LF, MF/HF	DSP w/EAW Focusing

PERFORMANCE

Operating Range: 55 Hz to 19 kHz

Nominal Beamwidth:

Horz 60°
Vert 45°

Axial Sensitivity (whole space SPL):

LF 103 dB	55 Hz to 550 Hz
MF/HF 113 dB	430 Hz to 19 kHz

Input Impedance (ohms)

Nominal	Minimum
LF1, LF2 (each) 4	4 @ 210 Hz
LF (total) 2	2 @ 210 Hz
MF/HF 8	6.3 @ 3120 Hz

High Pass Filter

High Pass =>60 Hz, 12 dB/octave Butterworth

Accelerated Life Test

LF1, LF2 (each) 63 V	1000 W @ 4 ohm
LF (total) 63 V	2000 W @ 2 ohm
MF/HF 37 V	175 W @ 8 ohm

Calculated Axial Output Limit (whole space SPL)

Average	Peak
LF 136 dB	142 dB
MF/HF 135 dB	141 dB

ORDERING DATA

Description	Part Number
EAW QX564i 3-Way Full-Range Loudspeaker Black	2039615
EAW QX564i 3-Way Full-Range Loudspeaker White	2039625
EAW QX564i-WP 3-Way Full-Range Loudspeaker Black	2039620

Optional Accessories

Adapter Bracket QX BLK [ACC-ABQX]	2036437
Weather Protection Shield QX BLK [ACC-WPSQX]	2036515
U-Bracket Horizontal QX BLK [UBKT-QXH]	2036568

ENCLOSURE

Material Exterior-grade Baltic birch plywood
 Finish Wear resistant textured black paint
 Grille Powder-coated perforated steel

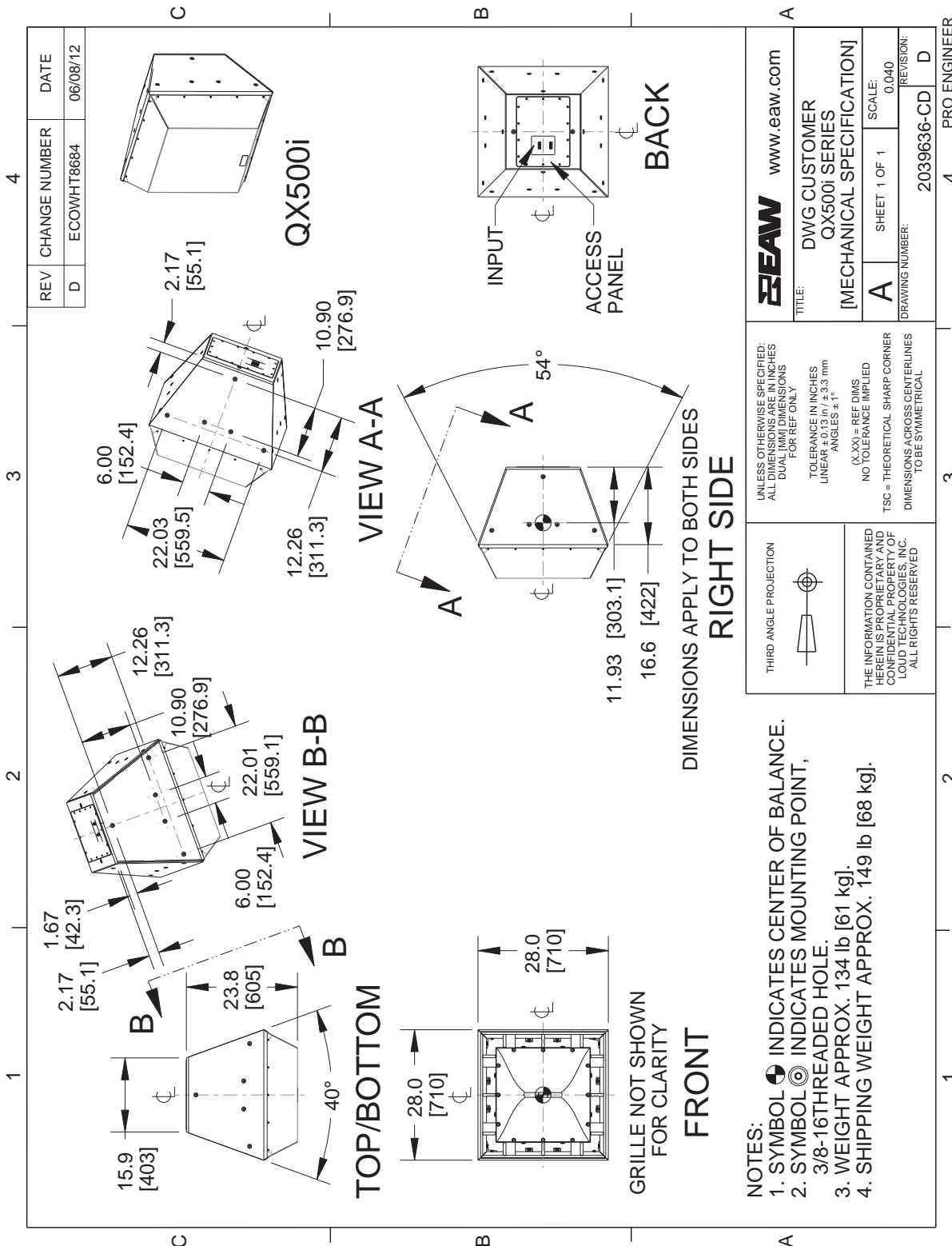

NOTE: This drawing has been reduced. Do not scale.

PERFORMANCE DATA

See *NOTES GRAPHIC DATA* for details

Frequency Response: Processed

LF = green, HF = black, Complete = blue

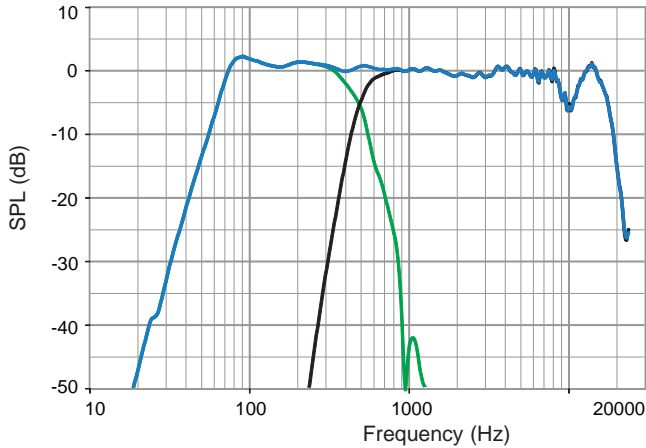

Frequency Response: Unprocessed

LF = green, HF = black

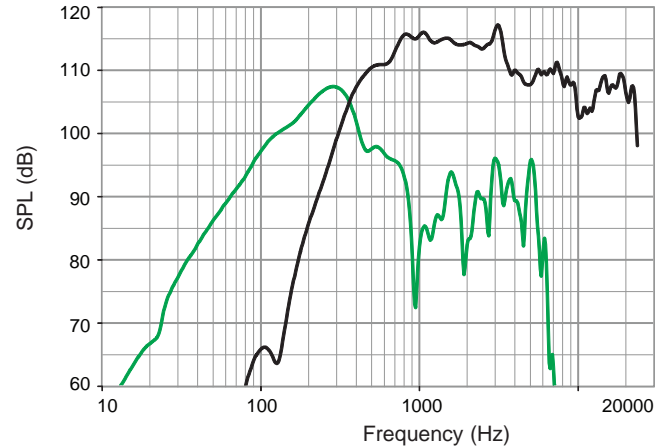

Impedance

LF = green, HF = black

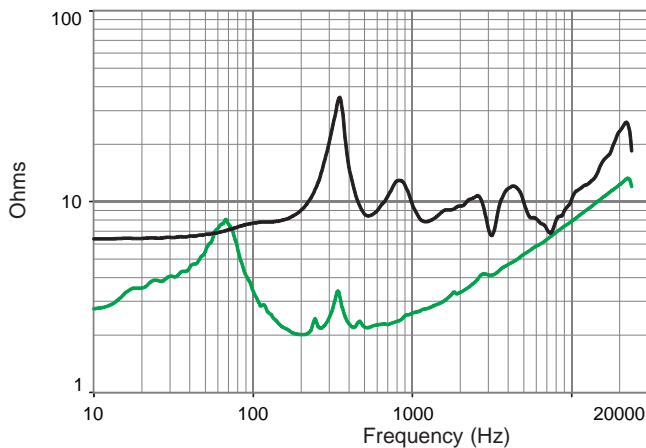

Phase Linearity

Complete = blue

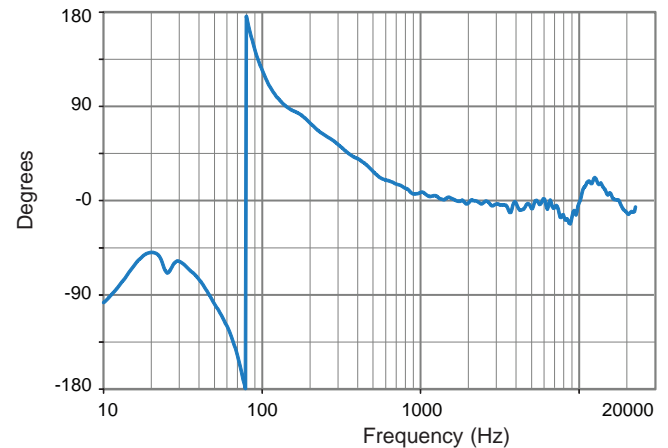

Beamwidth

Horizontal = orange Vertical = black

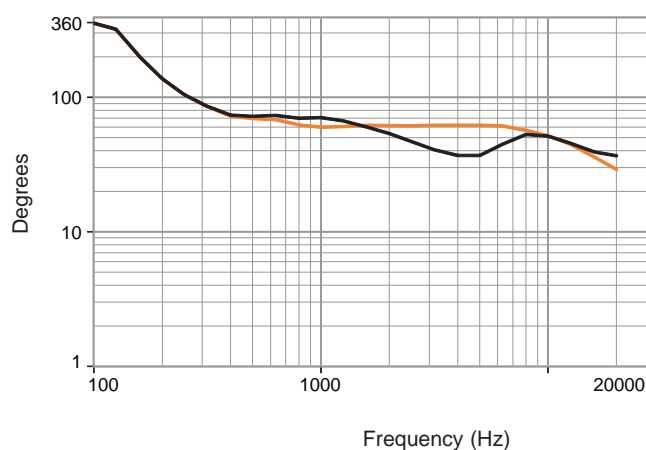

HORIZONTAL POLAR DATA

See *NOTES GRAPHIC DATA* for details

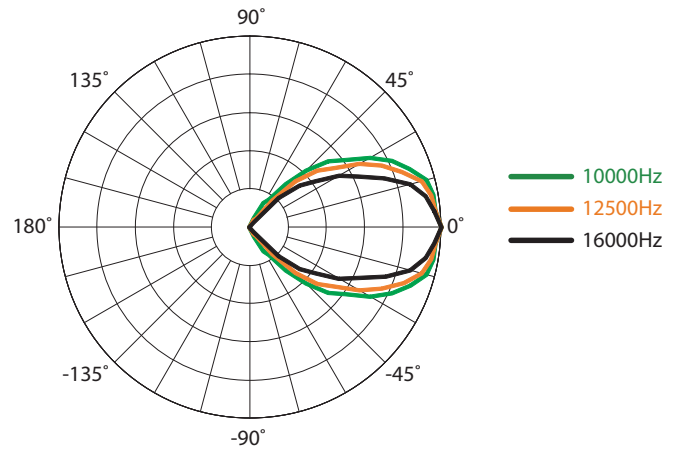
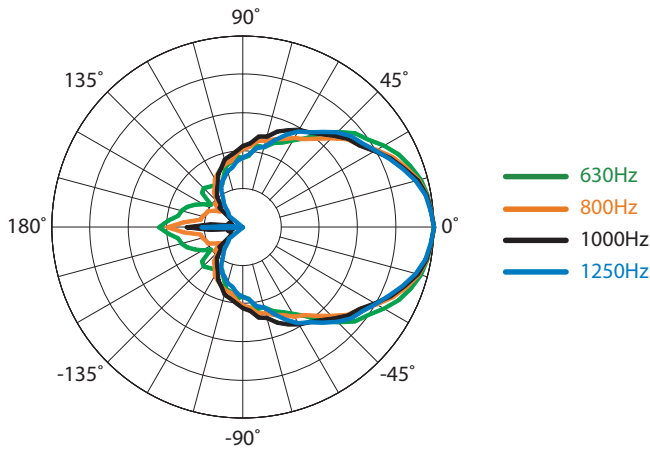
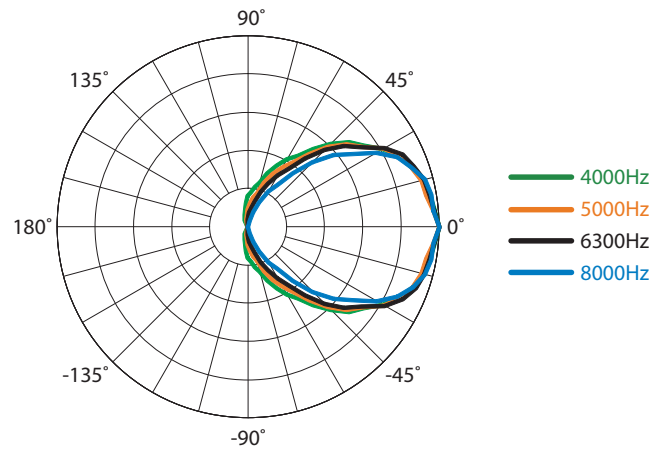
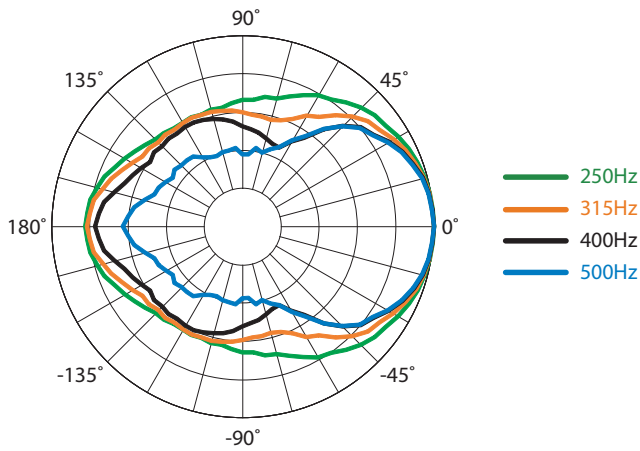
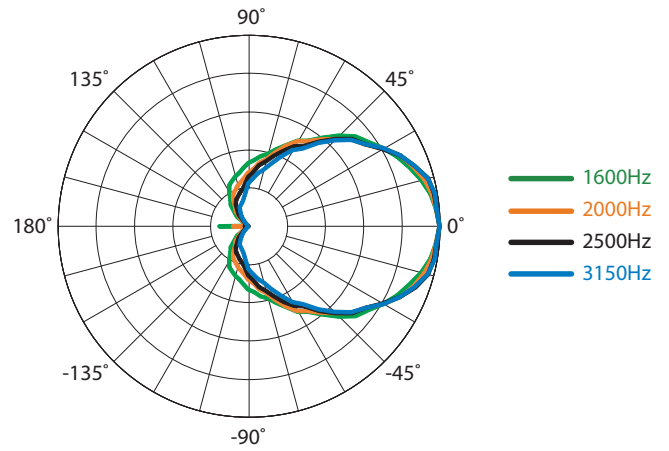
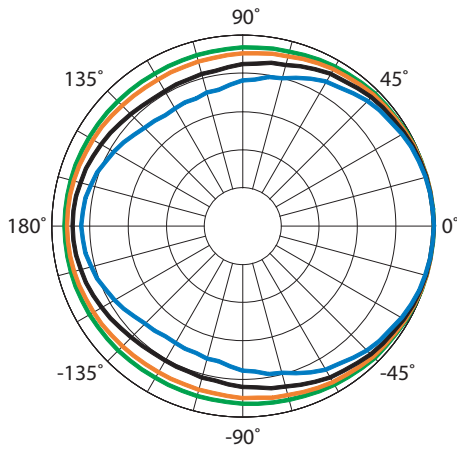

VERTICAL POLAR DATA

See *NOTES GRAPHIC DATA* for details

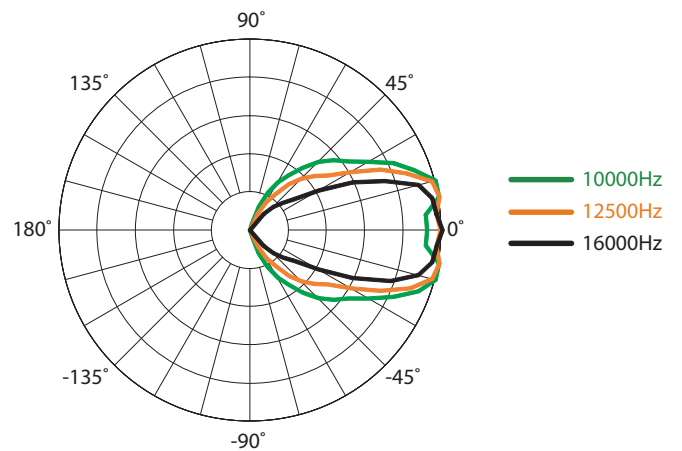
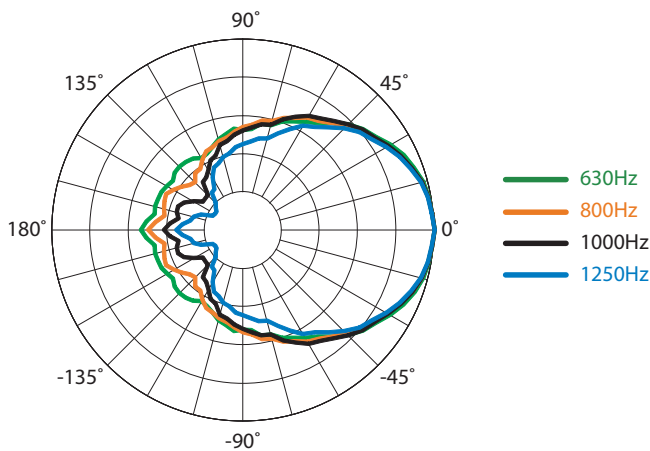
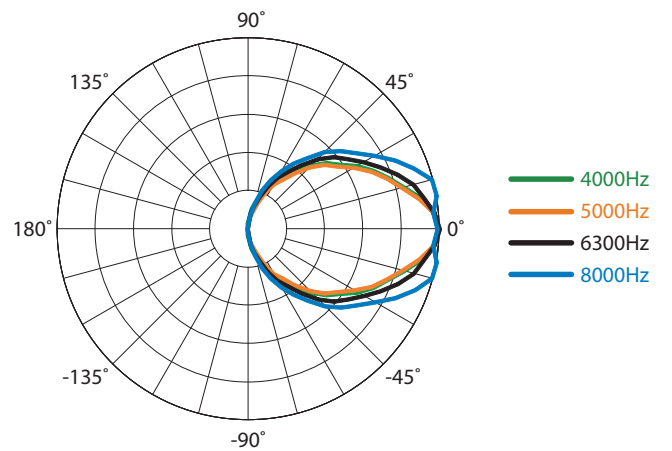
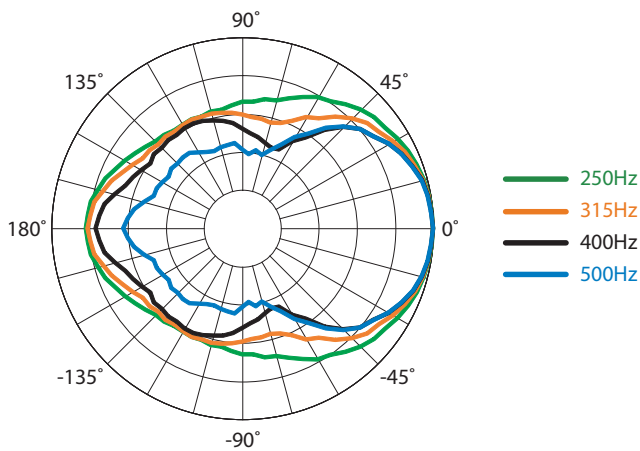
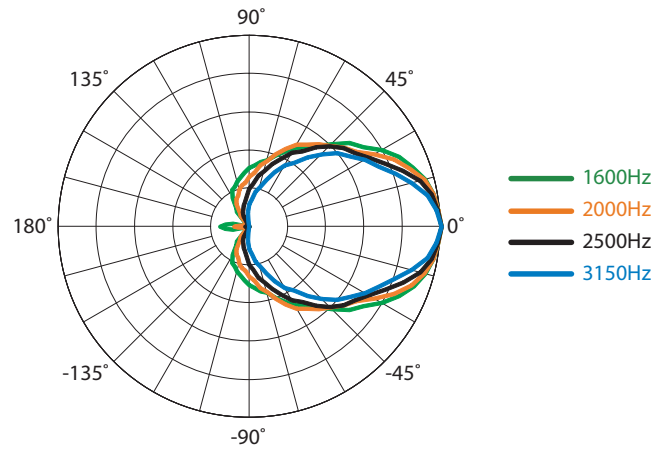
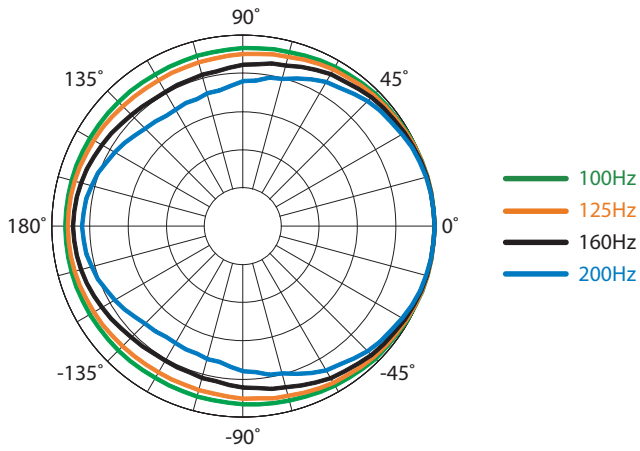

INPUT PANEL

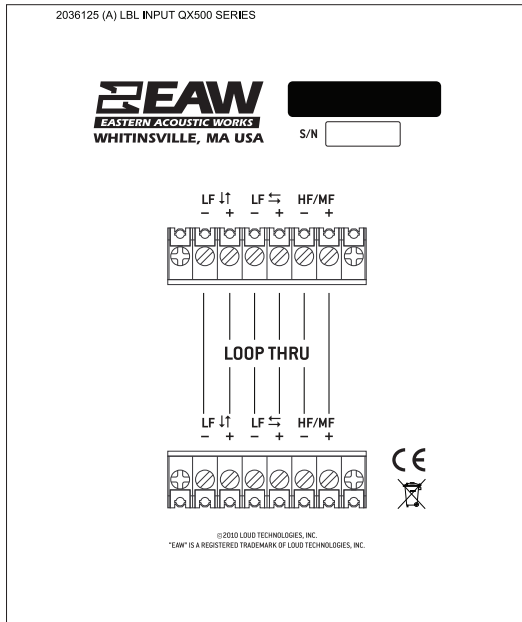

SIGNAL DIAGRAM

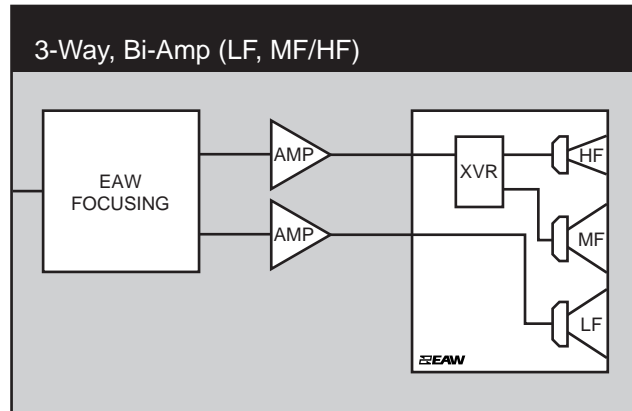

LEGEND

- HPF:** High Pass Filter for crossover –or– Recommended High Pass Filter.
- LPF:** Low Pass Filter for crossover.
- LF/MF/HF:** Low Frequency / Mid Frequency / High Frequency.
- AMP:** User Supplied Power Amplifier –or– Integral Amplifier for NT products.
- XVR:** Passive LPFs, HPFs, and EQ integral to the loudspeaker.
- EAW Focusing:** Digital Signal Processor capable of implementing EAW Focusing.

NOTES

TABULAR DATA

1. **Measurement/Data Processing Systems:** Primary - FChart; proprietary EAW software; Secondary - Brüel & Kjær 2012.
2. **Microphone Systems:** Earthworks M30; Brüel & Kjær 4133
3. **Measurements:** Dual channel FFT; length: 32 768 samples; sample rate: 48 kHz; logarithmic sine wave sweep.
4. **Measurement System Qualification** (includes all uncertainties): SPL: accuracy ± 0.2 dB @ 1 kHz, precision ± 0.5 dB 20 Hz to 20 kHz, resolution 0.05 dB; Frequency: accuracy $\pm 1\%$, precision ± 0.1 Hz, resolution the larger of 1.5 Hz or 1/48 octave; Time: accuracy ± 10.4 μ s, precision ± 0.5 μ s, resolution 10.4 μ s; Angular: accuracy $\pm 1^\circ$, precision $\pm 0.5^\circ$, resolution 0.5°.
5. **Environment:** Measurements time-windowed and processed to eliminate room effects, approximating an anechoic environment. Data processed as anechoic or fractional space, as noted.
6. **Measurement Distance:** 7.46 m. Acoustic responses represent complex summation of the subsystems at 20 m. SPL is referenced to other distances using the Inverse Square Law.
7. **Enclosure Orientation:** For beamwidth and polar specifications, as shown in Mechanical Specification drawing.
8. **Volts:** Measured rms value of the test signal.
9. **Watts:** Per audio industry practice, "loudspeaker watts" are calculated as voltage squared divided by rated nominal impedance. Thus, these are not True Watt units of energy as defined by International Standard.
10. **SPL:** (Sound Pressure Level) Equivalent to the average level of a signal referenced to 0 dB SPL = 20 microPascals.
11. **Subsystem:** This lists the transducer(s) and their acoustic loading for each passband. Sub = Subwoofer, LF = Low Frequency, MF = Mid Frequency, HF = High Frequency.
12. **Operating Mode:** User selectable configurations. Between system elements, a comma (,) = separate amplifier channels; a slash (/) = single amplifier channel. DSP = Digital Signal Processor. **IMPORTANT:** To achieve the specified performance, the listed external signal processing must be used with EAW-provided settings.
13. **Operating Range:** Range where the processed Frequency Response stays within -10 dB SPL of the power averaged SPL within this range; measured on the geometric axis. Narrow band dips are excepted.
14. **Nominal Beamwidth:** Design angle for the -6 dB SPL points, referenced to 0 dB SPL as the highest level.
15. **Axial Sensitivity:** Power averaged SPL over the Operating Range with an input voltage that would produce 1 W at the nominal impedance; measured with no external processing on the geometric axis, referenced to 1 m.
16. **Nominal Impedance:** Selected 4, 8, or 16 ohm resistance such that the minimum impedance point is no more than 20% below this resistance over the Operating Range.
17. **Accelerated Life Test:** Maximum test input voltage applied with an EIA-426B defined spectrum; measured with recommended signal processing and Recommended Protection Filter.
18. **Calculated Axial Output Limit:** Highest average and peak SPLs possible during the Accelerated Life Test. The Peak SPL represents the 2:1 (6 dB) crest factor of the Life Test signal.
19. **High Pass Filter:** This helps protect the loudspeaker from excessive input signal levels at frequencies below the Operating Range.

GRAPHIC DATA

1. **Resolution:** To remove insignificant fine details, 1/12 octave cepstral smoothing was applied to acoustic frequency responses and 1/3 octave cepstral smoothing was applied to the beamwidth and impedance data. Other graphs are plotted using raw data.
2. **Frequency Responses:** Variation in acoustic output level with frequency for a constant input signal. Processed: normalized to 0 dB SPL. Unprocessed inputs: 2 V (4 ohm nominal impedance), 2.83 V (8 ohm nominal impedance), or 4 V (16 ohm nominal impedance) referenced to a distance of 1 m.
3. **Processor Response:** The variation in output level with frequency for a constant input signal of 0.775 V = 0 dB reference.
4. **Beamwidth:** Average angle for each 1/3 octave frequency band where, starting from the rear of the loudspeaker, the output first reaches -6 dB SPL referenced to 0 dB SPL as the highest level. This method means the output may drop below -6 dB SPL within the beamwidth angle.
5. **Impedance:** Variation in impedance magnitude, in ohms, with frequency without regard to voltage/current phase. This means the impedance values may not be used to calculate True Watts (see 9 above).
6. **Polar Data:** Horizontal and vertical polar responses for each 1/3 octave frequency band 100 Hz to 16 kHz or Operating Range.